

Artemide®

2	Human and Responsible Light
6	The Innovation
10	High Manufacturing
14	Bespoke products
18	Light in 5 Years Time
22	The designers
24	Index
26	Alphabetical index
32	Table lamps
136	Floor lamps
210	Suspension lamps
388	Wall/Ceiling lamps
542	Masters' Pieces
590	IN-EI ISSEY MIYAKE
608	Technical Sheets
640	Artemide. Augmented Reality
642	Artemide. 5 Years Warranty
644	The Total Cost Ownership
646	General legenda
648	Light sources
650	Energy label
652	Addresses

Human and Responsible Light.

La luce è una presenza quotidiana nelle nostre vite. Centrale è da sempre nella visione di Artemide il rapporto tra uomo, luce e ambiente, che negli anni si è sviluppato declinandosi dagli aspetti rivolti al benessere dell'individuo e alla sua percezione degli spazi, fino a confrontarsi con i temi legati alla sostenibilità ambientale e a comprendere l'attenzione alla natura e a tutti gli esseri viventi. The Human Light è la luce in grado di seguire il fluire dei ritmi, dei comportamenti e delle emozioni degli individui, la luce progettata per il benessere psicologico dell'uomo, in grado di offrire nuove qualità, emozioni e consapevolezza alla nostra vita e di aprire una visione innovativa e responsabile sul futuro del mondo. Con The Human Light la luce diviene materia prima plasmabile, strumento attivo a supporto del Sé, un mezzo per riappropriarsi di stimoli e sensazioni. L'autodeterminazione nel rapporto che si crea tra luce e uomo, va interpretata non solo come diritto di gestione flessibile alla portata di tutti, ma soprattutto come un dovere nel rispetto di un corretto bilancio energetico.

Progettare la luce significa andare oltre l'aspetto puramente funzionale dell'illuminazione e abbracciare una dimensione più ampia che faccia capo a una nuova attenzione per l'esperienza percettiva, i bisogni psicologici e fisiologici. La conoscenza e consapevolezza di Artemide su questo tema, legate alle ricerche sviluppate dagli anni '90' ad oggi con università, centri di ricerca, esperti di diverse discipline scientifiche (medicina, biologia, psicologia, antropologia) hanno portato allo sviluppo di sistemi di illuminazione innovativi. Nel suo percorso Artemide ha progettato non solo prodotti ma mezzi per creare scenari luminosi variabili con cui interagire e vivere il rapporto con la luce in modo nuovo, più diretto e consapevole: Metamorfoosi, A.I.s.o., Tunable White fino a Spectral Light.

Light is a constant feature of our life. The vision of Artemide is traditionally focused on the relation between man, light, and the environment, which developed in time in view of ensuring a person's wellbeing and space perception and confronted with environmental sustainability issues, also with a focus on nature and all living beings. The Human Light is a light that follows the pace, behaviour, and emotions of individuals, a light designed for man's psychological wellbeing, capable to bring new quality, emotions, and consciousness into our life and to open up an innovative, responsible overview of the planet's future. With The Human Light, light becomes a shapeable raw material, an active instrument supporting the Self, a means to regain stimuli and sensations. Self-determination in the relation established between man and light should be interpreted as a right to flexible management available to all, as well as, in particular, a duty aimed at appropriate energy balance. Designing light means reaching beyond the purely functional role of lighting and embracing a broader dimension that leads to a new focus on the perceptive experience, on psychological and physiological needs. At Artemide, the knowledge and awareness of this theme, combined with the research carried out from the 1990s to this day in cooperation with universities, think-tanks, and experts in a variety of scientific subjects (medicine, life sciences, psychology, anthropology), have resulted into the development of innovative lighting systems. Throughout its development process, Artemide designed products, as well as instruments to create variable luminous scenarios to interact with and to offer a new, more straightforward and conscious way to experience the relation with light: Metamorfoosi, A.I.s.o., Tunable White, and down to Spectral Light.

Spectral light prosegue il percorso di ricerca che da anni Artemide sviluppa sulla sostenibilità, la percezione psicologica e fisiologica. Dalla ricerca sulle lunghezze d'onda percepite non solo dall'uomo ma differenti specie di animali e piante sono state selezionate quelle necessarie per vedere, per crescere, per nutrirsi dei benefici della luce.

Spectral light continues the research that Artemide has been developing for many years on sustainability, as well as on psychological and physiological perception. From research on wavelengths perceived both by man and by a variety of animal and plant species, the necessary ones were selected to see, grow, and enjoy the benefits of light.

Spectral light continue le parcours de recherche qu'Artemide poursuit depuis des années sur la durabilité, la perception psychologique et physiologique. Partant de la recherche sur les longueurs d'onde perçues non seulement par l'homme mais par différentes espèces d'animaux et de plantes, on a sélectionné celles qui sont nécessaires pour voir, grandir et se nourrir des bénéfices de la lumière.



La lumière est une présence quotidienne dans nos vies. Central depuis toujours dans la vision d'Artemide, le rapport entre l'être humain, la lumière et l'environnement qui, au fil des ans, s'est développé en se déclinant, allant des aspects orientés au bien-être de l'individu et à sa perception des espaces, jusqu'à se confronter aux thèmes liés à la durabilité environnementale, tout en comprenant l'attention à la nature et à tous les êtres vivants. The Human Light est la lumière en mesure de suivre le flux des rythmes, des comportements et des émotions des individus, la lumière conçue pour le bien-être psychologique de l'homme, en mesure d'offrir de nouvelles qualités, émotions, consciences à notre vie et d'ouvrir une vision innovante et responsable sur l'avenir du monde. Avec The Human Light, la lumière devient une matière première malléable, un instrument actif support du Soi, un moyen pour se réapproprier de stimuli et sensations. L'autodétermination dans le rapport qui se crée entre la lumière et l'être humain doit être interprétée non seulement comme droit de gestion flexible à la portée de tous mais surtout comme un devoir dans le respect d'un bilan énergétique correct.

Concevoir la lumière signifie transcender l'aspect purement fonctionnel de l'éclairage et embrasser une dimension plus vaste dérivant d'une nouvelle attention pour l'expérience de la perception, les nécessités psychologiques et physiologiques. La connaissance et la conscience d'Artemide sur ce thème, liées aux recherches développées allant des années 90 à notre époque, avec des universités, centres de recherche, experts en différentes matières scientifiques (médecine, biologie, psychologie, anthropologie) ont amené au développement de systèmes d'éclairage innovants. Dans son parcours, Artemide a conçu non seulement des produits mais des instruments pour créer des scénarios lumineux variables avec lesquels interagir et vivre le rapport avec la lumière d'une manière nouvelle, plus directe et consciente : Metamorfoosi, A.I.s.o., Tunable White jusqu'à Spectral Light.

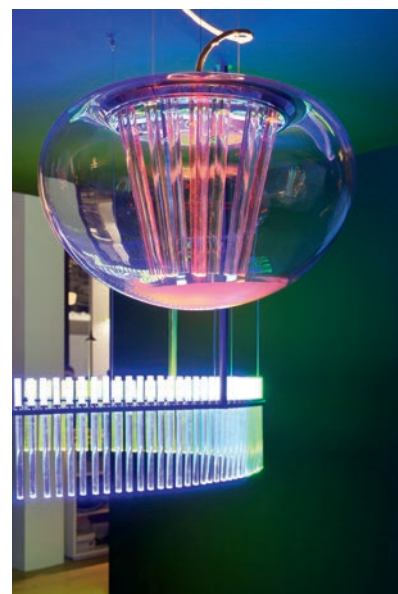

Spectral light setzt den Suchpfad fort, den Artemide seit Jahren zur Nachhaltigkeit, psychologischen sowie physiologischen Wahrnehmung entwickelt. Die Forschung gilt Wellenlängen, die nicht nur vom Menschen wahrgenommen werden, sondern von verschiedenen Tieren und Pflanzen, die das Licht zum Sehen, zum Wachsen und um sich zu ernähren benötigen.

Spectral light continúa el recorrido de investigación que desde hace años Artemide desarrolla acerca de la sostenibilidad y la percepción psicológica y fisiológica. A partir de la investigación sobre las longitudes de onda, percibidas no solo por el hombre sino por diferentes especies de animales y plantas, se han seleccionado aquellas necesarias para ver, crecer y nutrirse de los beneficios de la luz.

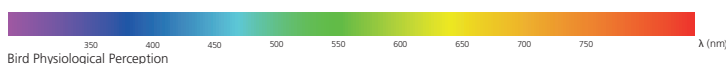

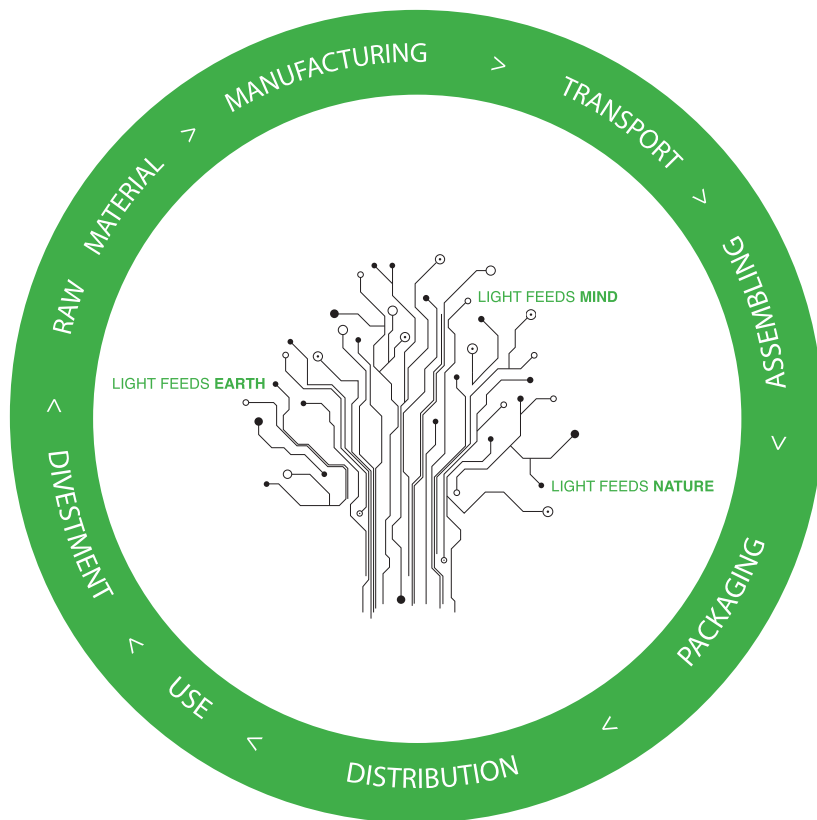

Das Licht ist eine tägliche Präsenz in unserem Leben. Seit jeher ist bei der Vision von Artemide die Beziehung zwischen Mensch, Licht und Umwelt zentral, die sich im Laufe der Jahre entwickelt hat und sich durch die Aspekte zum Wohlbefinden des Menschen und seiner Wahrnehmung des Raumes dekliniert, bis zum Auseinandersetzen mit Themen zur ökologischen Nachhaltigkeit, und um die Liebe zur Natur und allen Lebewesen zu verstehen. Das Licht von The Human Light ist in der Lage, dem Fluss der Rhythmen, Verhalten und Emotionen der Menschen zu folgen. Das Licht für das psychische Wohlbefinden des Menschen ist in der Lage, unserem Leben neue Qualitäten, Emotionen und Bewusstsein zu bieten und eine innovative und verantwortungsvolle Vision zur Zukunft der Welt zu öffnen.

Mit The Human Light wird das Licht zum formbaren Rohstoff und aktiven Instrument zur Unterstützung vom Selbst, ein Mittel, um Reize und Empfindungen zurück zu erlangen. Die Selbstbestimmung in der Beziehung, die zwischen Licht und Mensch entsteht, wird nicht nur als Recht auf eine flexible Lichtsteuerung für jedermann interpretiert, sondern vor allem als Pflicht hinsichtlich einer korrekten Energiebilanz.

Licht zu planen bedeutet, über die rein funktionalen Aspekte der Beleuchtung hinauszugehen und eine größere Dimension zu erfassen, die einen neuen Schwerpunkt auf die Wahrnehmung sowie psychologischen und physiologischen Bedürfnisse setzt. Das Wissen und Bewusstsein von Artemide zu diesem Thema durch Forschungen, die aus den 90er Jahren bis heute mit Hochschulen, Forschungszentren, Experten aus verschiedenen wissenschaftlichen Disziplinen (Medizin, Biologie, Psychologie, Anthropologie) durchgeführt wurden, haben zur Entwicklung von innovativen Beleuchtungssystemen geführt. Artemide hat auf seinem Weg nicht nur Produkte entworfen, sondern Instrumente, um variable Leucht-Szenarien zu erzeugen, um die Beziehung mit dem Licht auf neue, direktere und bewusstere Weise zu interagieren und zu erleben: Metamorfosi, A.I.s.o., Tunable White bis Spectral Light.

L'attività di ricerca di Artemide è costantemente impegnata a sviluppare ed adottare sistemi di illuminazione che perseguano l'obiettivo della massima efficienza energetica e del progetto di lunga durata attraverso un'attenta progettazione dell'intero ciclo di vita del prodotto.

LCA (Life Cycle Assessment) è un approccio strategico utilizzato per valutare il potenziale impatto ambientale che un prodotto ha in tutte le fasi del suo ciclo di vita: scelta delle materie prime, lavorazioni, trasporto e assemblaggio, imballaggio, distribuzione, fase d'uso, dismissione e riciclaggio.

Artemide's research activity is constantly committed to developing and adopting lighting systems that pursue the objective of maximum energy efficiency and always thinking to the long term through a careful planning of the entire product life cycle.

LCA (Life Cycle Assessment) is a strategic approach used to assess the potential environmental impact of a product during all stages of its life cycle: selection of raw materials, processing, transport and assembly, packaging, distribution, usage, disposal and recycling.

Les services de recherche d'Artemide travaillent constamment au développement et à l'adoption de systèmes d'éclairage visant à garantir la plus haute efficacité énergétique au moyen d'une étude approfondie du cycle de vie du produit. LCA (Life Cycle Assessment) est une approche stratégique utilisée pour évaluer le potentiel de l'impact environnemental d'un produit durant toutes les étapes de son cycle de vie : sélection des matières premières, traitement, transport et assemblage, emballage, distribution, phase d'utilisation, déchets et recyclage.

Die Forschungstätigkeit von Artemide ist konstant damit beschäftigt, Beleuchtungssysteme mit maximaler Energieeffizienz zu entwickeln. LCA (Life Cycle Assessment) oder auch Ökobilanz, beschreibt die systematische Analyse der Wirkung von Produkten auf die Umwelt über den gesamten Produktlebenszyklus: Auswahl der Rohmaterialien, Verarbeitung, Transport und Montage, Verpackung, Vertrieb, Gebrauch, Entsorgung und Recycling.

La actividad que Artemide despliega en el sector de la investigación aspira constantemente a desarrollar y utilizar sistemas de iluminación que persigan un objetivo: conseguir la máxima eficiencia energética y diseñar con miras a una larga vida útil proyectando atentamente todo el ciclo de vida del producto. LCA (Life Cycle Assessment) es un enfoque estratégico utilizado para valorar el potencial impacto ambiental que un producto tiene en todas las fases de su ciclo de vida: elección de materias primas, procesos, transporte y montaje, embalaje, distribución, fase de uso, la destrucción y el reciclaje.

La luz es una presencia cotidiana en nuestras vidas. Artemide siempre ha considerado central la relación entre el hombre, la luz y el ambiente, que en los años se ha desarrollado desplegándose desde los aspectos dirigidos al bienestar del individuo y su percepción de los espacios, hasta medirse con los temas vinculados con la sostenibilidad medioambiental e incluir la atención a la naturaleza y todos los seres vivos.

The Human Light es la luz capaz de seguir el flujo de los ritmos, los comportamientos y las emociones de los individuos, la luz diseñada para el bienestar psicológico del hombre, capaz de ofrecer cualidades, emociones y conciencia nuevas a nuestra vida y abrir una visión innovadora y responsable sobre el futuro del mundo. Con The Human Light la luz se convierte en materia prima moldeable, herramienta activa en apoyo al Sí-mismo, un medio para recuperar estímulos y sensaciones. La autodeterminación en la relación que se crea entre luz y hombre, ha de interpretarse no solo como derecho de gestión flexible al alcance de todos, pero sobre todo como un deber en el respeto de un equilibrio energético correcto.

Diseñar la luz significa ir más allá del aspecto puramente funcional de la iluminación y abrazar una dimensión más amplia que haga referencia a una nueva atención hacia la experiencia perceptiva y las necesidades psicológicas y fisiológicas. El conocimiento y la conciencia de Artemide sobre este tema, vinculadas a las investigaciones desarrolladas a partir de los años 90 hasta hoy con universidades, centros de investigación, expertos en diferentes disciplinas científicas (medicina, biología, psicología, antropología) han llevado al desarrollo de sistemas de iluminación innovadores. En su desarrollo Artemide ha diseñado no solo productos sino herramientas para crear escenarios luminosos variables con los que interactuar y vivir la relación con la luz de una nueva manera, más directa y consciente: Metamorfosi, A.I.s.o., Tunable White hasta Spectral Light.

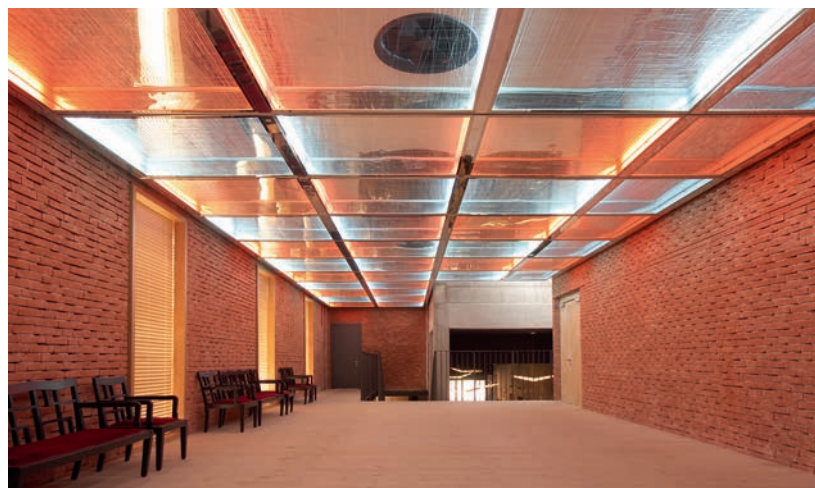

La luce, variando colore o temperatura, costruisce emozioni e relazioni. Le radiazioni luminose che raggiungono i nostri occhi vengono trasformate in impulsi elettrici e trasmesse, mediante il nervo ottico, al cervello. Da qui si origina una serie di input che vengono trasmessi a tutto l'organismo. Conseguenza di tali reazioni neurofisiologiche è una variazione significativa del tono dell'umore in funzione della quantità e della qualità di luce a cui è esposto un individuo.

By changing colour or temperature, light builds emotions and relationships. The light radiations reaching our eyes are transformed into electric impulses and transmitted to the brain via the optic nerve. The consequence of these neurophysiological reactions is a significant mood swing depending on the quantity and quality of light to which an individual is exposed.



En changeant de couleur ou de température, la lumière participe aux émotions et aux relations. Les radiations lumineuses qui atteignent nos yeux sont transformées en impulsions électriques et transmises au cerveau par le nerf optique. Le cerveau émet alors une série d'ordres qui sont transmis à tout l'organisme. La conséquence de ces réactions neurophysiologiques est une variation significative de l'humeur en fonction de la quantité et de la qualité de lumière à laquelle un individu est exposé.

Farb- oder Temperaturvariationen des Lichts beeinflussen Gefühle und Beziehungen. Die Lichtstrahlen, die auf unsere Augen treffen, werden in elektrische Impulse verwandelt und über den Sehnerv an unser Gehirn weitergeleitet. Hier bildet sich eine Reihe an Inputs für den gesamten Organismus. Eine Folge dieser neurophysiologischen Reaktionen ist eine bedeutsame Schwankung der Stimmungslage je nach Quantität und Qualität des Lichts, dem ein Individuum ausgesetzt ist.

La luz, al variar de color o de temperatura, construye emociones y relaciones. Cuando las radiaciones luminosas llegan a nuestros ojos, se transforman en impulsos eléctricos. A continuación, éstos se transmiten al cerebro a través del nervio óptico. Aquí tiene origen una serie de impulsos que se transmiten a todo el organismo. A consecuencia de dichas reacciones neurofisiológicas, se produce una variación importante del humor, en función de la cantidad y la calidad de la luz a la que el ser humano se ve expuesto.

The Innovation.

La tecnologia LED ha rivoluzionato il mondo della luce offrendo interessanti opportunità per lo sviluppo di generazioni di prodotti concettualmente nuovi. Tuttavia nel campo della luce oggi il progresso tecnologico non è più accessibile a tutti, è più complesso e richiede interpreti competenti: la creatività del designer deve necessariamente confrontarsi con un team specializzato. Per questo motivo Artemide si è dotata negli anni di una struttura di ricerca e sviluppo dove trovano posto le più diverse e specializzate competenze tecniche, laboratori accreditati e sistemi di qualità certificati.

Il progetto è per Artemide ricerca e cultura, parte dalla convergenza di una costante innovazione tecnologica e di un approccio di tipo umanistico. Ricerca e innovazione optoelettronica, uso di materiali e tecniche di produzione all'avanguardia, attenzione all'efficienza e alla qualità della performance, riflessioni sulla capacità della luce di relazionarsi con l'ambiente circostante in un dialogo digitale, sono guidate da valori con l'obiettivo di dare continuamente un contributo alla qualità della vita dell'uomo e del pianeta.

I numerosi brevetti di invenzione che accompagnano lo sviluppo dei prodotti Artemide e i riconoscimenti internazionali in campo di innovazione e sostenibilità testimoniano la sua tensione progettuale verso il futuro. L'innovazione è fatta di persone, della loro cultura e competenza ma soprattutto è data da una sperimentazione continua e da una visione condivisa.

The LED technology has revolutionized the lighting world and offered interesting opportunities to develop generations of products based on new concepts. However, technological progress in the lighting business today is no longer accessible to all, in that it is more complicated and calls for highly skilled performers – a designer's creativity should necessarily confront with a specialized team. This is why, in time, Artemide has developed a research and development facility that hosts to a diverse range of specialized technical skills, accredited laboratories, and certified quality systems.

To Artemide, design is research and culture, and starts from the convergence of on-going technological innovation and a human approach. Optoelectronic research and innovation, the use of cutting-edge materials and manufacturing techniques, care for efficiency and high-quality performance, thoughts about the ability of light to relate with its surroundings in a digital dialogue are driven by values aimed at continuing to provide an input to improve the quality of man's and of the planet's life.

The many invention patents associated with the development of the Artemide products and the international acknowledgements obtained for innovation and sustainability bear evidence of the company's future-oriented design approach. Innovation is made of people, of their culture and competence, and is most of all the result of continuous experimentation and of a shared vision.

La technologie LED a révolutionné le monde de la lumière en offrant des possibilités intéressantes pour la création de générations de produits d'une conception tout à fait nouvelle. Toutefois, à l'heure actuelle, dans le domaine de la lumière le progrès technologique n'est plus accessible à tous ; il est plus complexe et demande des interprètes compétents : la créativité du designer doit nécessairement se confronter à une équipe spécialisée. C'est pour cette raison qu'au fil des ans Artemide s'est équipée d'une structure de recherche

Ameluna, Patent Pending MI102016000025996

Una progettualità sorprendente ed inaspettata combina la competenza di Artemide nella luce con il tratto distintivo di Mercedes-Benz Style nelle forme e nei materiali. Ameluna rivela una rivoluzionaria optoelettronica integrata nel corpo trasparente. L'ottica combinata con un nastro di alluminio che supporta i LED, un brevetto di invenzione, si inserisce nel profilo inferiore lasciando intatta la purezza della forma. La luce è diretta e parzialmente rifratta nell'ambiente attraverso il corpo trasparente.

A surprising and unexpected design approach combines the lighting skills of Artemide with the distinctive trait of Mercedes-Benz Style in forms and materials. Ameluna reveals a revolutionary optoelectronic unit integrated in its transparent body. The optical unit, combined with an aluminium band supporting the LEDs – an invention patent – is inserted into the lower edge without affecting the pure form. Light is direct, partially refracted in the environment through the clear body. The section geometry and the optical properties of materials ensure perfect emission control, despite the appliance's transparency.

Un esprit de conception surprenant et inattendu associe la compétence Artemide en matière de lumière au trait caractéristique du Mercedes-Benz Style dans les formes et les matières. Ameluna révèle une optoelectronique révolutionnaire intégrée dans le corps transparent. L'optique associée à un ruban d'aluminium qui soutient les LEDs, un brevet d'invention, s'insère dans le profil inférieur en laissant intacte la pureté de la forme. La lumière est directe et partiellement réfractée dans l'espace par le corps transparent. Par la géométrie de la section et les caractéristiques optiques des matières, on obtient un contrôle parfait de l'émission malgré la transparence.

et développement comprenant les compétences techniques les plus diverses et spécialisées, des laboratoires accrédités et des systèmes de qualité certifiés. Pour Artemide le projet est recherche et culture, il part de la convergence d'une innovation technologique constante et d'une approche de type humaniste. Recherche et innovation optoélectronique, utilisation de matières et techniques de production à l'avant-garde, attention à l'efficacité et à la qualité de la performance, réflexions sur la capacité de la lumière d'établir une relation avec le milieu dans un dialogue numérique, tout cela est guidé par des valeurs ayant pour but de donner sans cesse une contribution à la qualité de la vie de l'être humain et de la planète.

Les nombreux brevets d'invention qui accompagnent le développement des produits Artemide et les reconnaissances internationales dans les domaines innovation et durabilité témoignent sa tendance conceptuelle vers l'avenir. L'innovation est faite de personnes, de leur culture et de leur compétence, mais surtout d'une expérimentation continue et d'une vision partagée.

Die LED-Technologie hat die Welt des Lichts revolutioniert und bietet interessante Möglichkeiten zur Entwicklung von konzeptionell neuen Produktgenerationen. Aber in der Lichtbranche ist der technologische Fortschritt heute nicht mehr für alle zugänglich. Er ist viel komplexer und erfordert kompetente Dolmetscher: Die Kreativität des Designers muss notwendiger Weise mit einem spezialisierten Team konfrontiert werden. Aus diesem Grund hat sich Artemide im Laufe der Jahre mit einer Forschungs- und Entwicklungseinrichtung ausgestattet, bei der die vielfältigen und speziellen technischen Fähigkeiten, akkreditierten Laboratorien und zertifizierten Qualitätssysteme Platz finden.

Das Projekt ist für Artemide Forschung und Kultur. Es beginnt bei der Konvergenz einer konstanten technologischen Innovation und einem humanistischen Ansatz. Optoelektronik-Forschung und Innovation, die Nutzung von modernen Fertigungstechniken und Materialien, das Augenmerk auf Effizienz und Leistungsqualität, Betrachtungen zur Fähigkeit vom Licht, mit dem umliegenden Ambiente im digitalen Dialog zu stehen, sind Werte mit dem Ziel, zur Qualität des menschlichen Lebens und der Erde beizutragen.

Die zahlreichen Patente, welche die Produktentwicklung von Artemide begleiten, sowie die internationale Auszeichnungen auf dem Gebiet der Innovation und Nachhaltigkeit bestätigen den Planungsdruck in Richtung Zukunft. Innovation ist von Menschen sowie deren Kultur und Kompetenz gemacht, ist aber vor allem durch ein kontinuierliches Experimentieren und eine gemeinsame Vision gegeben.

Eine überraschende und unerwartete Planung vereint die Kompetenz von Artemide zum Licht mit der Besonderheit des Mercedes-Benz-Stils in Formen und Materialien. Ameluna zeigt eine revolutionäre Optoelektronik, die in einem durchsichtigen Körper integriert ist. Das Leuchtelement verbunden mit einem Aluminiumband, welches die LEDs trägt, (mit Patent der Erfindung) fügt sich in das untere Profil und lässt die Reinheit der Form intakt. Das Licht wird durch den transparenten Körper direkt und teilweise gebrochen in das Ambiente gerichtet. Durch die Geometrie der Einteilung und die Leuchteigenschaften des Materials wird selbst bei der Transparenz eine perfekte Kontrolle über die Lichtemission erhalten.

Una habilidad de realizar proyectos sorprendente e inesperada combina la competencia de Artemide en la luz con el sello distintivo de Mercedes-Benz Style en las formas y los materiales. Ameluna revela una optoelectrónica revolucionaria integrada en el cuerpo transparente. La óptica combinada con una cinta de aluminio que soporta los LEDs, una patente de invención, se inserta en el perfil inferior dejando intacta la pureza de la forma. La luz es directa y parcialmente refractada en el ambiente a través del cuerpo transparente. A través de la geometría de la sección y las características ópticas de los materiales se obtiene un control perfecto de la emisión incluso en la transparencia.

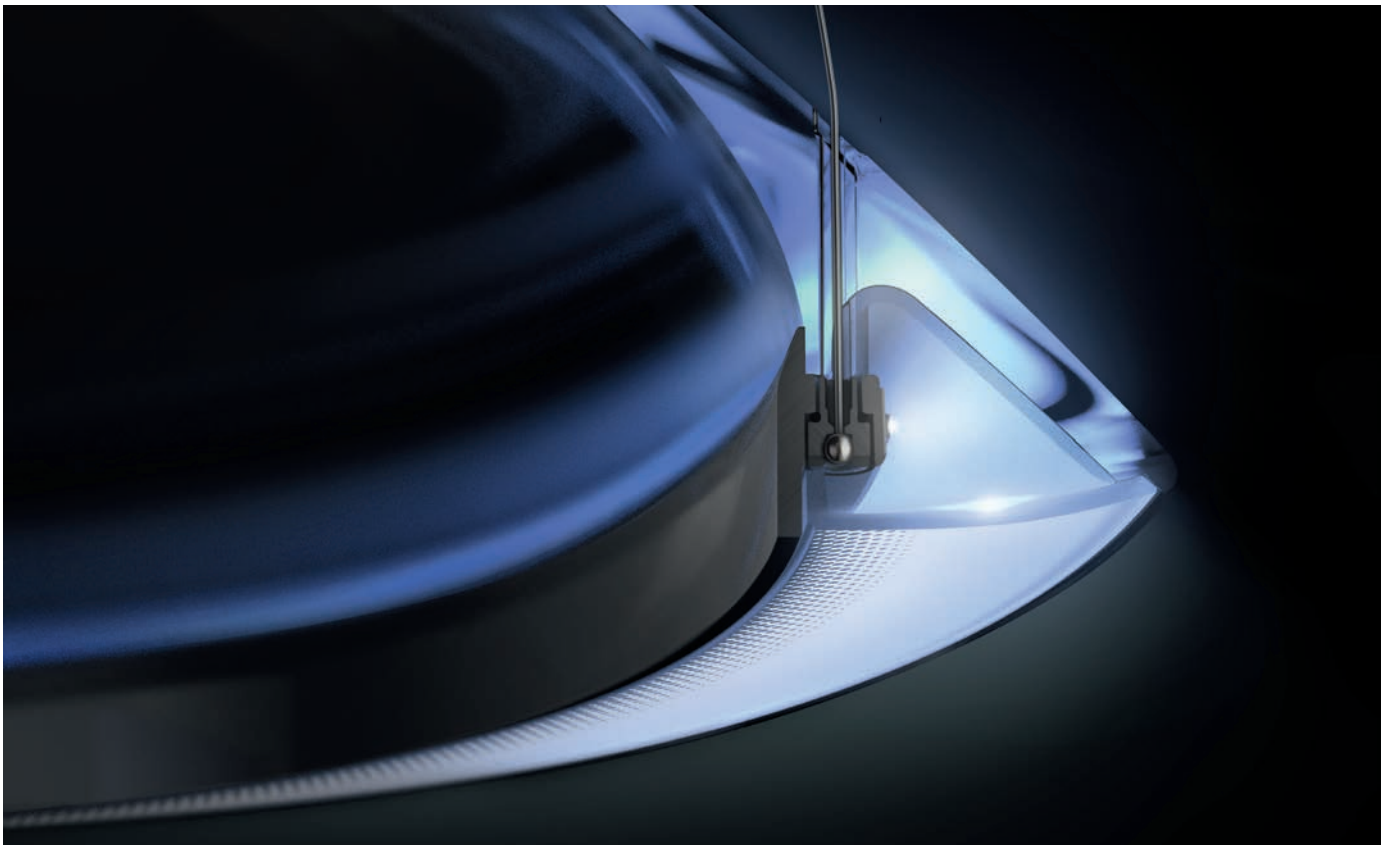

La tecnología LED ha revolucionado el mundo de la luz ofreciendo interesantes posibilidades para el desarrollo de generaciones de productos conceptualmente nuevos. Sin embargo, hoy en día, en el campo de la luz, el progreso tecnológico ya no es accesible a todos, es más complejo y requiere interpretes competentes: la creatividad del diseñador debe medirse necesariamente con un equipo de especializado. Por esta razón, en los últimos años, Artemide ha adoptado una estructura de investigación y desarrollo que incluye las competencias técnicas más diversas y especializadas, talleres acreditados y sistemas de calidad certificados. El diseño, para Artemide, es investigación y cultura, empieza por la convergencia de una innovación tecnológica constante y un enfoque de tipo humanístico. Investigación e innovación optoelectrónica, uso de materiales y técnicas de fabricación de vanguardia, atención a la eficiencia y a la calidad del rendimiento, reflexiones sobre la capacidad de la luz de interactuar con su entorno en un diálogo digital, se guían por valores cuya finalidad es contribuir de forma continua a la calidad de vida del hombre y del planeta. Las numerosas patentes de invención que acompañan el desarrollo de los productos Artemide y los premios internacionales en el ámbito de la innovación y la sostenibilidad son la prueba de su tensión proyectiva hacia el futuro. La innovación está hecha de personas, de su cultura y competencia pero sobre todo es fruto de una experimentación continua y una visión compartida.

Alphabeth of Light, Patent Pending MI102016000025996

A partire da un abaco di essenziali elementi geometrici BIG disegna un nuovo font che si traduce in luce. Questa idea si combina alla competenza optoelettronica di Artemide per definire un principio costruttivo innovativo e restituire una luce continua e confortevole. La combinazione della geometria della sezione e delle proprietà ottiche dei materiali crea una emissione diffusa ed uniforme senza ombre ed abbagliamento con al tempo stesso un rendimento elevato.

BIG starts from an abacus of essential geometries to design a new font that translates into light. This idea is associated with the optoelectronic skills of Artemide to define an innovative construction principle and produce continuous and comfortable light. The section geometry, combined with the optical properties of materials, creates a diffused, even, shadow-less, non-glaring emission, while ensuring a high yield.

A partir d'un abaque d'éléments géométriques essentiels, BIG trace un nouveau caractère qui se traduit par la lumière. Cette idée s'associe à la compétence optoélectronique d'Artemide pour définir un principe constructif innovant et restituer une lumière continue et confortable. L'association de la géométrie de la section et des propriétés optiques des matières crée une émission diffuse et uniforme sans ombres ni éblouissement avec, en même temps, un rendement élevé.

Ausgehend bei einem Abakus geometrischer Grundelemente zeichnet BIG ein neues Font, das sich in Licht übersetzt. Dieses Konzept verbindet sich mit der optoelektronischen Kompetenz von Artemide, ein innovatives Konstruktionsprinzip zu definieren und ein kontinuierliches und behagliches Licht wiederzugeben. Die Kombination der Geometrie zum Abschnitt und die Leuchteigenschaften der Materialien erzeugen eine diffuse und gleichmäßige Lichtemission ohne Schatten und Blendung von zugleich hoher Leistung.

A partir de un ábaco de elementos geométricos esenciales, BIG diseña una fuente nueva que se traduce en luz. Esta idea se combina con la competencia optoelectrónica de Artemide para definir un principio de construcción innovador y aportar una luz continua y confortable. La combinación de la geometría de la sección con las propiedades ópticas de los materiales crea una emisión difusa y uniforme sin sombras y deslumbramiento garantizando, al mismo tiempo, un alto rendimiento.

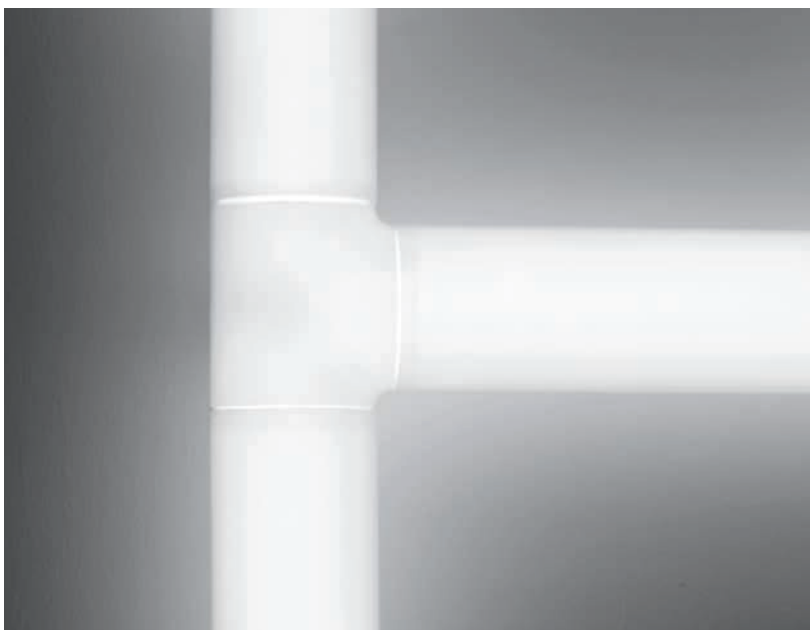



Copernico, Patent Pending MI2010A000610

Si tratta di un apparecchio di illuminazione con una geometria variabile che utilizza giunti meccanici specifici. Questi giunti hanno la doppia funzione sia orientare le varie sezioni del dispositivo stesso e per alimentare la potenza alimentazione di tutti i rami LED.

It is a variable-geometry lighting fixture that uses specific mechanical joints. These joints have double function either for orientating the several sections of the fixture itself and to feed the power supply to all the LED branches.

C'est un appareil d'éclairage à géométrie variable qui utilise des joints mécaniques spécifiques. Ces joints ont une double fonction, tant l'orientation des différentes sections du luminaire que l'alimentation électrique de toutes les branches LED.

Ein variabel geometrischer Leuchtenkörper, der spezielle mechanische Verbinder (Konnektoren) verwendet. Die Verbinder realisieren eine Doppelfunktionen, um die einzelnen Leuchtenabschnitte separat orientieren zu können und eine kabellose Stromversorgung aller LED-Abschnitte zu garantieren.

Es una luminaria de geometría variable que utiliza juntas mecánicas específicas. Estas juntas tienen doble función ya sea para orientar las diversas secciones de la propia luminaria como para alimentar la fuente de alimentación a todas las ramas LED.



Sisifo, Patent Pending MI2010A001399

Si tratta di un apparecchio di illuminazione con una guida di luce radiale che genera un'ampia ed omogenea superficie illuminante partendo da una sorgente LED concentrata.

It is a lighting fixture with a radial light guide that generates a wide and homogeneous illuminating surface from a concentrated LED source.

Il s'agit d'un appareil d'éclairage doté d'un guide radial lumineux que génère une surface d'illumination large et homogène à partir d'une source LED concentrée.

Leuchte mit radial ausrichtbarem Lichtaustritt, die eine breite und homogene Beleuchtungsstärke aus einer gerichteten LED-Lichtquelle realisiert.

Es un dispositivo de iluminación con una guía de luz radial que genera desde una fuente LED concentrada una superficie iluminada ancha y homogénea.

High Manufacturing.

Artemide è oggi sinonimo di design, competenza nel progetto della luce e innovazione con prodotti che sono espressione di ricerca ma prima di tutto di Made in Italy e grande qualità di manufacturing. Le collezioni Artemide rappresentano un incrocio unico di valori e competenze: l'approccio alla luce umana e responsabile si coniuga a un saper fare progettuale e materico, in un incontro tra tecnologia di ultima generazione e antichi saperi, perfetta espressione del progetto sostenibile. Artemide presidia i saperi del presente e del futuro ma tutela e valorizza in chiave contemporanea le conoscenze del passato come la lavorazione artigianale del vetro. Nell'headquarter di Pregnana Milanese si sviluppa e mette a punto ogni nuovo prodotto dalla sua concezione sino alla produzione industriale, garantendo i migliori risultati in termini di qualità e conformità agli standard internazionali. Laboratori certificati supportano a partire dalla ricerca tutte le fasi dello sviluppo del prodotto fino al suo rilascio sul mercato.

La costante ricerca alimenta il know-how produttivo sviluppato negli anni e sempre rinnovato alla luce delle nuove tecnologie non solo nell'unità produttiva di Pregnana Milanese ma anche nelle altre fabbriche europee del gruppo (Telgate (BG) e Venezia in Italia, St .Florent in Francia, Paks in Ungheria). Nell'ambito di una attenta politica ambientale la qualità è vista come un diritto fondamentale per un rapporto più duraturo con il prodotto, un'attenta progettazione dell'intero ciclo di vita è requisito indispensabile per la lunga durata e una autentica innovazione ambientale. Si ha la massima attenzione al processo di progettazione e produzione: uso responsabile delle risorse, accurata scelta dei processi e delle tecnologie in un'ottica di bilancio energetico.

Visione, valori, ricerca, competenza e capacità di manufacturing si traducono nel design della bellezza di prodotti senza tempo. Attraverso la cultura del progetto e il know how produttivo, unione di competenze scientifiche e patrimonio umanistico, la luce di Artemide può dare risposte concrete a un bisogno di qualità diffusa e accessibile. Artemide è come un grande osservatorio su tutte le tematiche che coinvolgono la luce, ma grazie ad un profondo know how sul manufacturing è capace di restituire il sapere attraverso il fare.

Today Artemide epitomizes design, lighting design competence, and innovation, with products that convey research and, particularly, the Made-in-Italy concept and high-quality manufacturing. The Artemide collections are a unique blend of values and competences: the company's approach to human and responsible light is combined with design and material savoir faire to create a mix of next-generation technology and ancient wisdoms – a perfect expression of sustainable design. Artemide holds the wisdom of the present and of the future, while valorizing the know-how of the past, such as craft glass processing, with a contemporary approach. Each new product is developed and fine-tuned – from its concept to industrial manufacturing – at the headquarters in Pregnana Milanese, thus ensuring the best results in terms of quality and compliance with international standards. Certified laboratories support all the phases of product development, from early studies to market release. Ongoing research expands the manufacturing know-how developed in time, which is constantly updated in the light of new technologies, both at the manufacturing unit in Pregnana Milanese and in the other European facilities of the group. Maximum care is given to the design and production process with a focus on a responsible use of resources and an accurate choice of processes and technologies in view of energy balance. Within the framework of a thorough environmental policy, quality is seen as

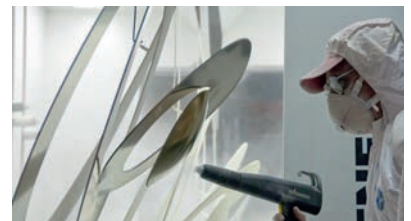

Visione, valori e ricerca si combinano a competenza e capacità di manufacturing. Per Artemide è essenziale il know-how produttivo sviluppato negli anni e sempre rinnovato alla luce delle nuove tecnologie non solo nell'unità produttiva di Pregnana Milanese ma anche nelle altre fabbriche del gruppo: Telgate (BG) in Italia, St .Florent in Francia, Paks in Ungheria, Montreal in Canada.

Vision, values, and research go hand in hand with competence and manufacturing capability. The manufacturing know-how developed in time and constantly renewed to leverage on new technologies is crucial to Artemide, both at the Pregnana Milanese manufacturing unit and at the other plants of the group in Telgate (BG) in Italy, St. Florent in France, Paks in Hungary, and Montreal in Canada.

La vision, les valeurs et la recherche progressent avec la compétence et la capacité du manufacturing. Pour Artemide, l'essentiel est le savoir-faire productif développé au fil des ans et toujours rénové par le biais des nouvelles technologies non seulement dans l'unité productive de Pregnana Milanese mais aussi dans les autres usines du groupe : Telgate (BG) en Italie, St .Florent en France, Paks en Hongrie, Montréal au Canada.

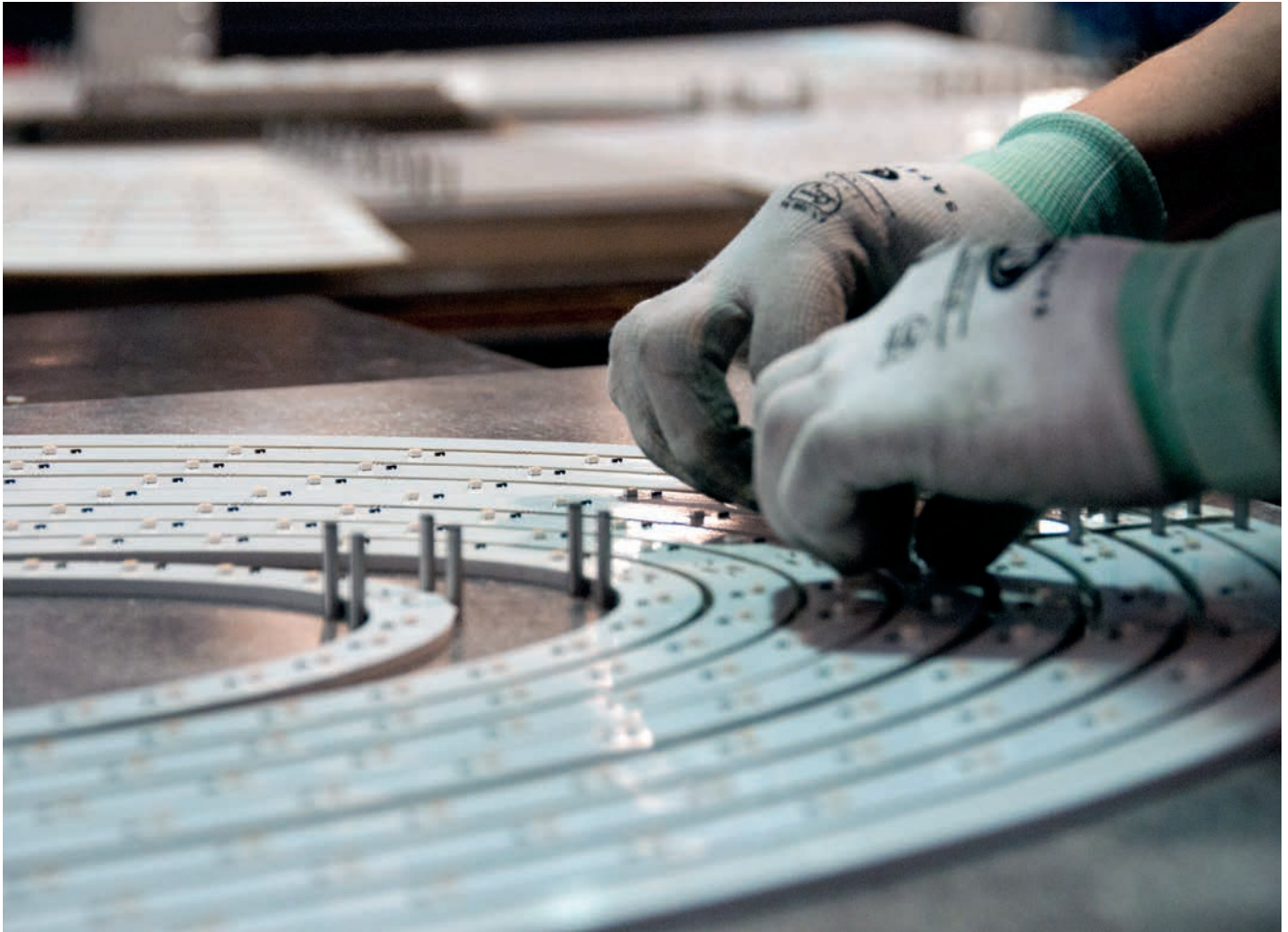

a fundamental right for a long-lasting relation with the product; careful design of the entire lifecycle is a prerequisite for a long life and for true environmental innovation. Vision, values, research, competence, and manufacturing skills translate into the design of beautiful timeless products. Through the culture of design and its manufacturing know how, which combines scientific and human skills, the light of Artemide can actually respond to the need for widespread and accessible quality. While Artemide investigates all light-related issues, it provides wisdom through action with its thorough manufacturing know how.

A l'heure actuelle, Artemide est synonyme de design, compétence dans la conception de la lumière et l'innovation avec des produits qui sont l'expression de la recherche mais avant tout du Made in Italy et de la grande qualité du manufacturing. Les collections Artemide représentent un carrefour unique de valeurs et de compétences : l'approche à la lumière humaine et responsable s'associe avec un savoir-faire conceptuel et matériel, en une rencontre entre la technologie de la dernière génération et les savoirs d'autrefois, expression parfaite du projet durable. Artemide veille sur les savoirs du présent et de l'avenir mais protège et valorise en clé contemporaine les connaissances du passé comme le travail artisanal du verre. Dans le QG de Pregnana Milanese, on développe et met au point chaque nouveau produit, de sa conception à la production industrielle, garantissant les meilleurs résultats en termes de qualité et conformité aux standards internationaux. Des laboratoires certifiés soutiennent dès les premières études toutes les phases du développement du produit jusqu'à sa sortie sur le marché. La recherche constante alimente le savoir-faire productif développé au fil des ans et toujours renouvelé à la lumière des nouvelles technologies non seulement dans l'unité productive de Pregnana Milanese mais aussi dans les autres usines européennes du groupe. La plus grande attention est portée au processus de conception et production : usage responsable des ressources, choix minutieux des processus et des technologies dans une optique de bilan énergétique. Dans le cadre d'une politique environnementale active, la qualité est vue comme un droit fondamental pour un rapport plus durable avec le produit ; une conception attentive de tout le cycle de vie est une condition indispensable pour une longue

Vision, Werte und Forschung vereinen sich mit Know-how und Manufacturing-Kapazitäten. Für Artemide ist das Fertigungs-Know-how wichtig, das in den Jahren angesammelt wurde und vor dem Hintergrund neuer Technologien nicht nur in der Produktionseinheit in Pregnana Milanese stets erneuert wurde, sondern auch in den anderen Werken der Gruppe. Telgate (BG) in Italien, St. Florent in Frankreich, Paks in Ungarn und Montreal in Kanada.

Visión, valores e investigación se combinan con la competencia y capacidad de manufacturing. Para Artemide es esencial el know-how productivo desarrollado en los años y siempre renovado a la luz de las nuevas tecnologías no solo en la unidad de producción de Pregnana Milanese sino también en las otras fábricas europeas del grupo. Telgate (BG) en Italia, St. Florent en Francia, Paks en Hungría, Montreal en Canadá.

durée et une innovation environnementale authentique. Vision, valeurs, recherche, compétence et capacité de manufacturing se traduisent en design de la beauté de produits intemporels. Par la culture du projet et le savoir-faire productif, l'association de compétences scientifiques et du patrimoine humaniste, la lumière d'Artemide peut donner des réponses concrètes à un besoin de qualité répandue et accessible. Artemide recherche à 360° sur tous les thèmes concernant la lumière mais, grâce à un grand savoir-faire sur le manufacturing, elle est en mesure de rendre le savoir par le faire.

Artemide steht heute als Synonym für Design, Kompetenz in der Lichtplanung und Innovation mit Produkten, die Ausdruck der Forschung sind, aber vor allem Made in Italy und eine hohe Qualität verkörpern. Die Kollektionen von Artemide stellen eine einzige Mischung an Werten und Kompetenzen dar: Das Annähern ans menschliche und nachhaltige Licht verbindet sich mit dem Know-how bei der Gestaltung und im Material. Es vereint neueste Technologie mit altem Wissen: perfekter Ausdruck nachhaltigen Gestaltens. Artemide besitzt das Wissen der Gegenwart und der Zukunft und schützt bzw. wertet das zeitgenössische Wissen der Vergangenheit wie die Glasbearbeitung auf. Der Hauptsitz in Pregnana Milanese entwickelt sich und erarbeitet jedes neue Produkt von der Konzeption bis zur industriellen Produktion, indem die besten Ergebnisse in Bezug auf Qualität und Einhaltung internationaler Standards gewährleistet werden. Zertifizierte Labors unterstützen alle Phasen beginnend bei den ersten Studien der Produktentwicklung bis zur Freigabe für den Markt. Die ständige Forschung nährt das Fertigungs-Know-how, das in den Jahren angesammelt wurde und sich vor dem Hintergrund neuer Technologien nicht nur in der Produktionseinheit in Pregnana Milanese sondern auch in den anderen europäischen Werken der Gruppe stets erneuert. Maximales Augenmerk wird auf Planung und Fertigung gerichtet: verantwortungsvoller Umgang mit den Ressourcen, sorgfältige Auswahl der Verfahren und Techniken hinsichtlich der Energiebilanz. Hinsichtlich einer sorgfältigen Umweltpolitik gilt Qualität als ein Grundrecht für eine länger anhaltende Beziehung mit dem Produkt. Eine aufmerksame Planung des gesamten Lebenszyklus ist Grundvoraussetzung für eine lange Lebensdauer und eine echte ökologische Innovation. Vision, Werte, Forschung, Fachwissen und Fertigungskapazitäten spiegeln sich im Design zeitloser Produkte wieder. Durch die Kultur des Designs, die Fertigungskompetenz, die Vereinigung von wissenschaftlichen Kompetenzen und humanistischem Erbe kann das

Nella vetreria di Venezia ogni pezzo è realizzato a mano con antiche tecniche artigianali che si tramandano da generazioni. Il saper fare unito alla bellezza della materia si traduce nell'unicità di ogni esemplare, nella magia dell'interazione tra il vetro e la luce.

Each item at the Venice glassworks is hand-made using craft techniques that are handed down across generations. The company's savoir faire, combined with the material's beauty, produces unique items through a magic interaction between glass and light.

Dans la verrerie de Venise, chaque pièce est réalisée à la main par d'anciennes techniques artisanales transmises d'une génération à l'autre. Le savoir-faire associé à la beauté de la matière se traduit dans chaque exemplaire unique, dans la magie de l'interaction entre le verre et la lumière.

In der Glashütte in Venedig wird jedes Stück mit alten handwerklichen Techniken händisch angefertigt, die von Generation zu Generation überliefert werden. Wissen kombiniert mit der Schönheit der Materie zeigt sich in der Einzigartigkeit jedes Exemplars und in der Magie der Wechselwirkung zwischen Glas und Licht.

En la vidriería de Venezia cada pieza está hecha a mano con antiguas técnicas artesanales que se transmiten de generación en generación. El saber hacer junto con la belleza de la materia se traduce en la unicidad de cada ejemplar, en la magia de la interacción entre el vidrio y la luz.

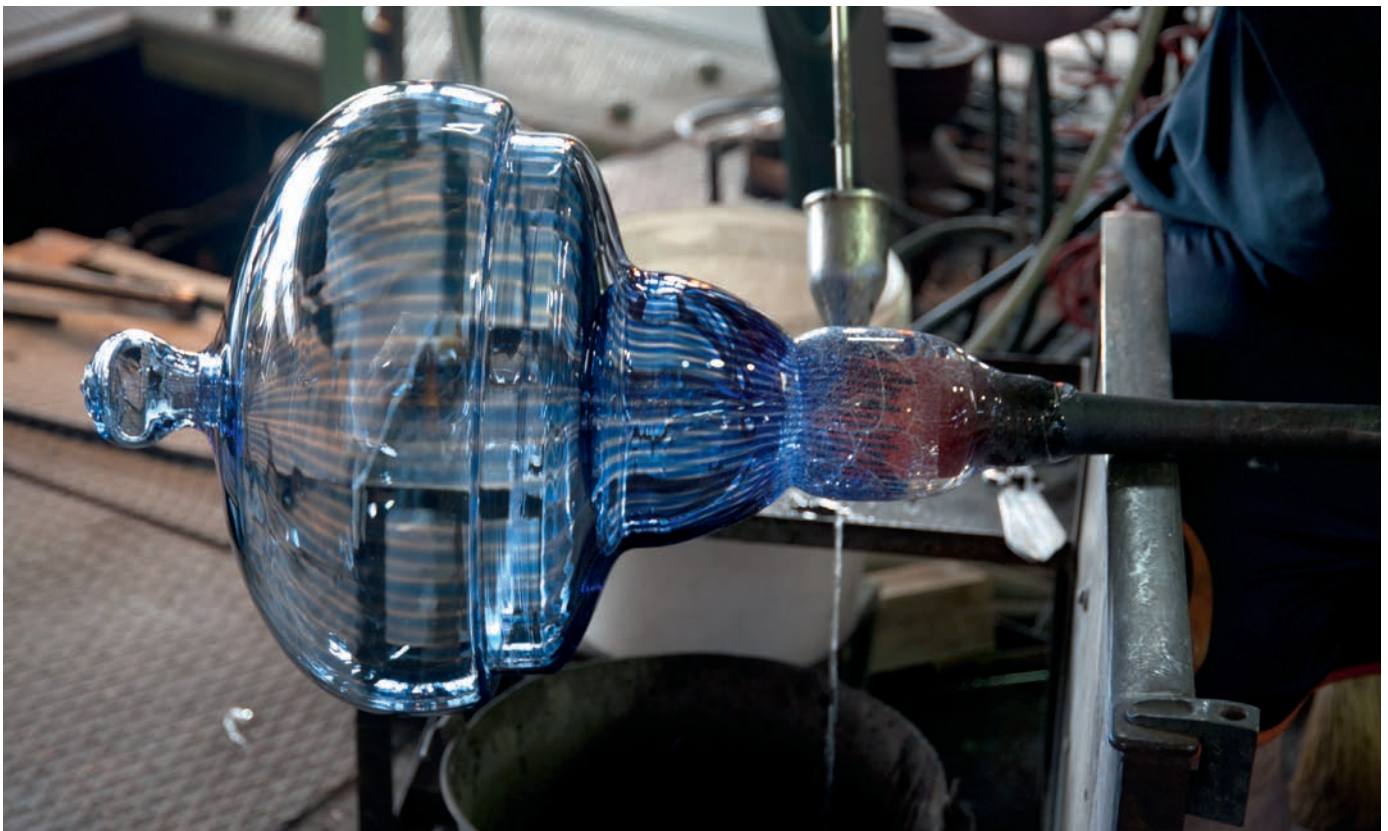

Licht von Artemide konkrete Antworten auf verbreitete und zugängliche Qualitätsbedürfnisse geben. Artemide recherchiert zu 360° zu allen Themen, die das Licht betreffen. Durch ein fundiertes Know-how in der Herstellung ist es in der Lage, dieses Wissen durch Taten umzusetzen.

Hoy en día Artemide es sinónimo de diseño, habilidad en el proyecto de la luz e innovación con productos que son expresión de investigación pero ante todo del Made in Italy y gran calidad de manufacturing. Las colecciones Artemide representan una confluencia única de valores y competencias: el enfoque a la luz humana y responsable se une a un saber hacer proyectivo y matérico, en un encuentro entre la tecnología de última generación y la sabiduría antigua, expresión perfecta del diseño sostenible. Artemide domina la sabiduría del presente y del futuro pero protege y pone en valor en clave contemporánea los conocimientos del pasado como la artesanía del vidrio. En la sede de Pregnana Milanese se desarrollan y se ponen a punto todos los nuevos productos, desde su concepción hasta la fabricación industrial, asegurando los mejores resultados en términos de calidad y cumplimiento de las normas internacionales. Laboratorios certificados apoyan, a partir de los primeros estudios, todas las fases del desarrollo del producto hasta su lanzamiento en el mercado. La investigación constante alimenta el know-how productivo desarrollado en los años y siempre renovado a la luz de las nuevas tecnologías no solo en la unidad de producción de Pregnana Milanese sino también en las otras fábricas europeas del grupo.

Se presta la máxima atención al proceso de diseño y fabricación: uso responsable de los recursos, elección cuidadosa de los procesos y de las tecnologías desde el punto de vista del balance energético. En el ámbito de una política medioambiental sostenible, la calidad está considerada un derecho fundamental para una relación más duradera con el producto, un diseño cuidadoso de todo el ciclo de vida es un requisito indispensable para una larga duración y una auténtica innovación ambiental. Visión, valores, investigación, competencia y capacidad de manufacturing se traducen en el diseño de la belleza de productos atemporales. A través de la cultura del diseño y el know how productivo, unión de competencias científicas y patrimonio humanístico, la luz de Artemide puede dar respuestas concretas a una necesidad de calidad difundida y asequible. Artemide investiga en 360° sobre todas las cuestiones relacionadas con la luz, pero gracias a un profundo know how sobre el manufacturing es capaz de devolver el saber a través del hacer.



Artemide ha laboratori certificati per supportare tutte le fasi dello sviluppo del prodotto, a partire dalla ricerca fino al suo rilascio sul mercato. Al suo interno tecnici qualificati eseguono test fotometrici, test per la sicurezza elettrica (il laboratorio è abilitato alla certificazione IMQ e UL) ed elettromagnetica, test meccanici, test sulle qualità dei materiali e delle finiture.

Artemide operates certified labs to support all the steps of the product-development process, from research to market release. Qualified in-house technicians perform photometric tests, electric and electromagnetic safety tests (the lab is qualified for IMQ and UL certification), mechanical tests, and tests on the quality of materials and finishes.

Artemide a des laboratoires certifiés pour suivre toutes les phases du développement du produit, allant de la recherche à la sortie sur le marché. A l'intérieur de ceux-ci, des techniciens qualifiés effectuent des tests photométriques, des tests pour la sécurité électrique (le laboratoire est habilité à la certification IMQ et UL) et électromagnétique, des tests mécaniques, des tests sur les qualités des matières et des finitions.

Artemide hat zertifizierte Laboratorien, um alle Phasen der Produktentwicklung zu unterstützen, angefangen bei der Forschung bis zur Freigabe für den Markt. In ihnen führen qualifizierte Techniker photometrische Tests, elektrische Sicherheitsprüfungen (das Labor ist zugelassen für die IMQ- und UL-Zertifizierung), elektromagnetische, mechanische Tests sowie Tests zur Qualität der Materialien bzw. der Oberflächen durch.

Artemide tiene laboratorios certificados para apoyar todas las fases del desarrollo del producto, a partir de la investigación hasta su lanzamiento en el mercado. En su interior técnicos cualificados realizan pruebas fotométricas, pruebas de seguridad eléctrica (el laboratorio está habilitado para la certificación IMQ y UL) y electromagnética, pruebas mecánicas, pruebas de calidad de los materiales y de los acabados.



Bespoke products.



Artemide offre un servizio completo rispetto ai progetti contract capace di svilupparsi su più livelli. È in grado di sviluppare soluzioni di prodotto personalizzate a partire da versioni già presenti a catalogo o di progettare e produrre soluzioni be-spoke. Al suo interno ha un dipartimento di progettazione dedicato ai progetti custom che sviluppa le differenti soluzioni in collaborazione con il resto dello staff di ricerca sviluppo e innovazione. La competenza Artemide nell'innovazione optoelettronica, il suo know-how tecnologico ed infine la grande qualità di manufacturing sono messe a disposizione di clienti e progettisti, per la realizzazione di progetti a 360° sia rispetto al prodotto che al disegno della luce nello spazio. Soluzioni custom possono riguardare prodotti già a catalogo declinati in nuove versioni, forme, dimensioni, modalità di gestione, performance di luce, caratteristiche tecniche o di installazione. Tra questi in particolare le collezioni Artemide presentano diversi prodotti concepiti per essere piattaforme aperte e modulari capaci di seguire con flessibilità le esigenze dei diversi spazi architettonici e funzionali. Da sempre Artemide crea importanti partnership, da queste collaborazioni con studi internazionali di architettura e lighting design o con top brand nascono soluzioni uniche, spesso particolarmente interessanti anche dal punto di vista culturale e della ricerca che ne deriva, che in diverse occasioni sono diventate stimolo allo sviluppo di prodotti oggi a catalogo.

Bespoke professional projector
Rondanini Museum
Project by Michele De Lucchi
Milan (Italy)

Artemide offers comprehensive service for contract projects, developed on multiple levels. The company can design customized solutions starting from existing products, as well as design and manufacture bespoke solutions. A dedicated in-house department takes care of custom-designed projects and develops individual solutions in cooperation with the staff in charge of

research, development, and innovation. The optoelectronic innovation skills, the technological know-how, and the high-quality manufacturing of Artemide are available for customers and designers to implement 360° projects, to help design products, as well as the behaviour of light in space. Custom-designed solutions may involve existing products in new versions, forms, dimensions, control modes, lighting performances, technical specifications, or installation features.

In particular, the Artemide collections include a variety of products that are conceived to act as open and modular platforms, in order to meet the requirements of individual architectural and functional spaces with utmost flexibility. Artemide traditionally establishes important partnerships with international architecture or lighting design firms and with top brands, which result into unique solutions, often interesting from the cultural viewpoint and for the research they stimulate. Many of these have triggered the process for development of some of the existing products.

Artemide offre un service complet par rapport aux projets contract et qui est en mesure de se développer sur plusieurs niveaux. La Société est en mesure de créer des solutions de produit personnalisées, à partir de versions déjà présentes dans son catalogue ou de concevoir et produire des solutions be-spoke. A l'intérieur, elle a un département de conception dédié aux projets custom, qui développe les différentes solutions en collaboration avec le reste du staff de recherche, développement et innovation. La compétence Artemide dans l'innovation optoélectronique, son know-how technologique et enfin la grande qualité de manufacturing sont mises à la disposition de clients et concepteurs, pour la réalisation de projets à 360° aussi bien par rapport au produit qu'au tracé de la lumière dans l'espace. Des solutions custom peuvent concerner des produits déjà dans le catalogue, déclinés dans de nouvelles versions, formes, dimensions, modalités de gestion, performances de lumière, caractéristiques techniques ou d'installation. Parmi ceux-ci, en particulier, les collections Artemide présentent différents produits conçus pour être des plates-formes ouvertes et modulaires en mesure de satisfaire de manière flexible les exigences des différents espaces architecturaux et fonctionnels. Depuis toujours Artemide crée d'importants partnerships ; de ces collaborations avec des bureaux internationaux d'architecture et lighting design ou avec des top brands naissent des solutions uniques, souvent particulièrement intéressantes également du point de vue culturel et de la recherche qui en dérive et qui, en différentes occasions, sont devenues un stimulus au développement de produits actuellement dans le catalogue.



Up:
Basilica di Santa Maria presso San Satiro
New lighting project by Giorgio Ripa - Area Studio S.r.l.
Milan (Italy)

Down:
Bespoke Glass Chandelier
Jean Nouvel Design, Château La Dominique
Saint-Émilion (France)



Artemide bietet einen kompletten Service hinsichtlich Vertragsprojekten, die sich auf mehrere Ebenen erstrecken können. Wir sind in der Lage maßgeschneiderte Produktlösungen zu entwickeln, beginnend bei bereits im Katalog bestehenden Versionen oder be-spoken Lösungen zu entwerfen und herzustellen. Wir haben intern eine Planungsabteilung für benutzerdefinierte Projekte, welche die verschiedenen Lösungen in Zusammenarbeit mit den weiteren Mitarbeitern von Forschung und Innovation entwickelt. Die Kompetenz von Artemide in der Optoelektronik-Forschung, sein technologisches Know-how und schließlich die hervorragende Qualität der Fertigung werden Kunden und Designern zur Verfügung gestellt, um vollkommene Projekte hinsichtlich Produkt und Design der Beleuchtung des Ambientes zu realisieren. Maßgeschneiderte Lösungen können bereits im Katalog bestehende Produkte umfassen, die sich in neuen Versionen, Formen, Größen, Steuerungsarten, Lichtleistungen, technischen Eigenschaften oder in der Installation ausdrücken. Unter diesen zeigen insbesondere die Kollektionen von Artemide verschiedene Produkte, die für offene und modulare Plattformen konzipiert sind und in der Lage sind, flexibel auf die Bedürfnisse der verschiedenen architektonischen und funktionalen Räume einzugehen. Seit jeher geht Artemide wichtige Partnerschaften durch diese Kooperationen durch internationale Studien der Architektur und zum Lichtdesign oder mit Top-Marken ein und es entstehen einzigartige Lösungen, die oft auch aus kultureller Sicht und hinsichtlich der daraus entstehenden Forschung besonders interessant sind. In verschiedenen Situationen sind sie zum Antrieb zur Entwicklung von Produkten geworden, die im Katalog aufgenommen wurden.



Up:
Bespoke Empatia chandelier
Bookshop Biennale di Venezia
Venice (Italy)

Down:
Bespoke Chlorophilia Cluster
NH Hotel, Milan (Italy)

To the left:
Bespoke Unterlinden table and suspension,
Fondazione Giangiacomo Feltrinelli
Project by Herzog & de Meuron
Milan (Italy)

Estamos en una época en que la evolución de la técnica ofrece oportunidades interesantes a la hora de desarrollar generaciones de productos nuevos, desde el punto de vista conceptual. Sin embargo, en el sector de la luz, actualmente el progreso tecnológico no es accesible para todo el mundo. Es más complejo y requiere intérpretes competentes: la creatividad del diseñador debe dialogar indefectiblemente con un equipo de especialistas. Por esta razón, desde hace años, Artemide posee una estructura de I+D, donde tienen cabida las competencias técnicas más variadas y especializadas. Y a la misma se suman los laboratorios acreditados y los sistemas de calidad certificados de la Casa. Por un lado, en Artemide, la innovación se traduce en el uso de los LED y de las fuentes de luz de ahorro energético, en el uso de materiales y técnicas de producción innovadoras, en la atención que se le presta a la eficiencia y a la calidad de las prestaciones. Por otro, la investigación y la innovación tecnológica se interpreta en su vertiente humanística, con el objeto de poner siempre el propio grano de arena a favor de la calidad de vida del ser humano y el planeta. Para Artemide, el diseño es investigación y cultura y nace de la convergencia de la innovación tecnológica y de un planteamiento de tipo antropológico. Las numerosas patentes de invención que acompañan al desarrollo de los productos de Artemide y los reconocimientos internacionales, en el campo de la innovación y la sostenibilidad, dan fe de su andar hacia del nuevo campus y laboratorio de ideas también se puede interpretar como una muestra del esfuerzo y la voluntad de la firma de crecer en base a un planteamiento holístico y multidisciplinar, con arreglo a los principios de sostenibilidad y eficiencia energética, prestando siempre atención a la investigación.



To the left:
Bespoke Mercury
National Theatre
Project by Ragim Seyfullayev
Photo by Khalid Ahmadov
Baku (AZ)

Down:
Bespoke Mercury
Roissy Charles de Gaulle Airport
Project by Marc Fidelle
Photo by Didier Boy de la Tour
Paris (FR)

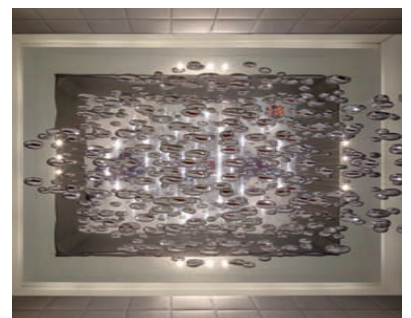

Light in 5 Years Time.

Artemide apre importanti temi di ricerca sulla fotonica e le nuove tecnologie per delineare una visione futura, un nuovo modo di interpretare e vivere la luce. Si muove verso nuove frontiere del progetto, dall'atomo al bit, dove centrale non è più solo il prodotto in sé.

A partire dalla duplice connotazione della luce come fenomeno allo stesso tempo ondulatorio e corpuscolare la ridefinizione del ruolo e delle potenzialità della luce passa attraverso idee che vanno al di là del prodotto, verso nuove intelligenze di gestione e informazione. Oggi la progettualità deve quindi offrire un'alternativa migliore a quello che già abbiamo, un design interattivo tra le frontiere tecnologiche e la cultura umanistica contemporanea, che sia in grado di attivare esperienze e di intercettare i comportamenti e le emozioni delle persone. Internet of things è esattamente questo, la possibilità di nuove relazioni e di nuove forme di consapevolezza e di controllo dell'ambiente: permette di sviluppare progetti rivolti all'esperienza dinamica ed interattiva della luce in un dialogo digitale verso una luce sociale. Le opportunità date da questa accelerazione tecnologica sono molte. Il tempo del transfer tecnologico, quello che passa tra la ricerca e l'applicazione, è sempre più ridotto. Questo ha aperto nuove concrete frontiere del progetto per Artemide: LiFi, sistemi di gestione intelligenti e digitali, app, fino alla progettazione di veri e propri software come LoT.

Artemide opens up important research issues connected with photonics and new technologies to outline a future vision, a new way to interpret and experience light. The company is moving towards the new frontiers of design – from the atom to the bit – where the core is no longer just the product as such. A review of the role and potentials of light, which starts from its dual connotation as both an undulating and a corpuscular phenomenon, passes through ideas that reach beyond the product, towards a new management and information intelligence. Design today should provide a better alternative to existing items, an interactive design between technological frontiers and the contemporary human culture, capable to promote experiences and to capture the behaviours and emotions of people. The Internet of Things provides an opportunity to generate new relations and new forms of environmental



LiFi

La luce rende visibile l'invisibile, ma è anche in grado di trasportare dati e informazioni. Gli oggetti stessi potranno elaborare e veicolare la luce e i dati attraverso l'energia luminosa. Artemide conduce una ricerca sul LiFi con la Scuola Superiore Sant'Anna di Pisa: la luce visibile è sfruttata per la trasmissione di dati, con gli stessi LED normalmente utilizzati nei prodotti Artemide si può realizzare una infrastruttura capace di gestire anche l'informazione.

LiFi

Light makes the invisible visible, but can also carry data and information. Objects themselves will be able to process and convey light and data through luminous energy. Artemide carries out research on LiFi in partnership with Scuola Superiore Sant'Anna, Pisa: visible light is used for data transmission. With the same LEDs that are normally fitted in the Artemide products, an infrastructure can be created to process data.

LiFi

La lumière rend visible l'invisible mais elle est aussi en mesure de transporter des données et des informations. Les objets eux-mêmes pourront élaborer et véhiculer la lumière et les données par l'énergie lumineuse. Artemide conduit une recherche sur le LiFi avec Scuola Superiore Sant'Anna de Pise : la lumière visible est utilisée pour la transmission de données ; les mêmes LEDs normalement utilisés dans les produits Artemide permettent de réaliser une infrastructure pouvant également gérer l'information.

LiFi

Licht macht das Unsichtbare sichtbar und ist zudem in der Lage, Daten und Informationen zu transportieren. Objekte selbst können Licht und Daten durch Lichtenergie erarbeiten und übertragen. Artemide führt mit der Scuola Superiore Sant'Anna di Pisa eine Forschung zur LiFi: Das sichtbare Licht dient zur Übertragung von Daten. Mit den gleichen LEDs, die gewöhnlich in den Produkten von Artemide verwendet werden, kann eine Infrastruktur erzeugt werden, die in der Lage ist, Informationen zu steuern.

LiFi

La luz hace visible lo invisible, pero también puede transportar datos e información. Los objetos mismos podrán elaborar y transportar la luz y los datos a través de la energía luminosa. Artemide lleva a cabo una investigación sobre el LiFi con la "Scuola Superiore Sant'Anna" de Pisa: la luz visible se aprovecha para la transmisión de datos, con los mismos LEDs normalmente utilizados en los productos Artemide se puede realizar una infraestructura capaz de gestionar también la información.



awareness and control, allows to develop projects for a dynamic and interactive experience with light in a digital dialogue aimed at social lighting. This technological acceleration provides multiple opportunities. The time for technological transfer – from research to implementation – is gradually shrinking. This has opened up new real frontiers for design at Artemide: LiFi, smart and digital management systems, as well as the design of true software applications, like LoT.

Artemide crée d'importants thèmes de recherche sur la photonique et les nouvelles technologies pour tracer une vision future, une nouvelle manière d'interpréter et de vivre la lumière. Elle évolue vers de nouvelles frontières du projet, de l'atome au bit, où le produit en soi n'est plus seul dans la centralité. A partir de la double connotation de la lumière comme phénomène à la fois ondulatoire et corpusculaire, la redéfinition du rôle et du potentiel de la lumière passe par des idées transcendant le produit, vers de nouvelles intelligences de gestion et information. A l'heure actuelle, la conception doit offrir une alternative meilleure à ce que nous avons déjà, un design interactif entre les frontières technologique et la culture humaniste contemporaine, qui soit en mesure de mettre en route des expériences et d'intercepter les comportements et les émotions des personnes. Internet of things donne la possibilité de créer de nouvelles relations et de nouvelles formes de conscience et de contrôle de l'environnement : il permet de développer des projets orientés à l'expérience dynamique et interactive de la lumière dans un dialogue numérique vers une lumière sociale. Les opportunités données par cette accélération technologique sont nombreuses. Le temps du transfert technologique, celui qui passe entre la recherche et l'application, est toujours plus réduit. Ceci a ouvert de nouvelles frontières concrètes du projet pour Artemide : LiFi, systèmes de gestion intelligents et numériques, jusqu'à la conception de véritables logiciels comme LoT.

TargetPoint

Artemide sviluppa con LightCube, spin-off dell'Università di Padova, un sistema di retroazione attivo di illuminamento e temperatura di colore attraverso comunicazione wireless tra prodotti IoT ready. TargetPoint consente un dialogo bidirezionale tra apparecchi di illuminazione, sensori e sistemi di controllo così che fenomeni naturali ed ambientali possano interagire con la luce artificiale secondo parametri misurati.

TargetPoint

With LightCube, a spin-off of the Padua University, Artemide is developing an active illumination and colour temperature retroaction system via wireless communication between IoT-ready products. TargetPoint allows a two-way dialogue between lighting appliances, sensors, and control systems, so that natural and environmental phenomena can interact with artificial light according to measured parameters.

TargetPoint

Artemide développe avec LightCube, spin-off de l'Université de Padoue, un système de rétroaction actif d'éclairage et température de couleur par une communication wireless entre les produits IoT ready. TargetPoint permet un dialogue bidirectionnel entre les appareils d'éclairage, les capteurs et les systèmes de contrôle afin que des phénomènes naturels et environnementaux puissent interagir avec la lumière artificielle selon des paramètres mesurés.

TargetPoint

Artemide entwickelt LightCube, ein Spin-off der Universität Padua, einem aktives Feedback-System zur Beleuchtung und Farbtemperatur über drahtlose Kommunikation zwischen IoT ready-Produkten. TargetPoint ermöglicht einen Zwei-Wege-Dialog zwischen Beleuchtungsgeräten, Sensoren und Steuerungssystemen, so dass das künstliche Licht mit den natürlichen Phänomenen und der Umwelt entsprechend gemessener Parameter interagieren kann.

TargetPoint

Artemide desarrolla con LightCube, spin-off de la Universidad de Padua, un sistema de retroacción activo de iluminancia y temperatura de color a través de comunicación inalámbrica entre productos IoT ready. TargetPoint permite un diálogo bidireccional entre dispositivos de iluminación, sensores y sistemas de control de manera que, fenómenos naturales y ambientales puedan interactuar con la luz artificial de acuerdo con parámetros medidos.

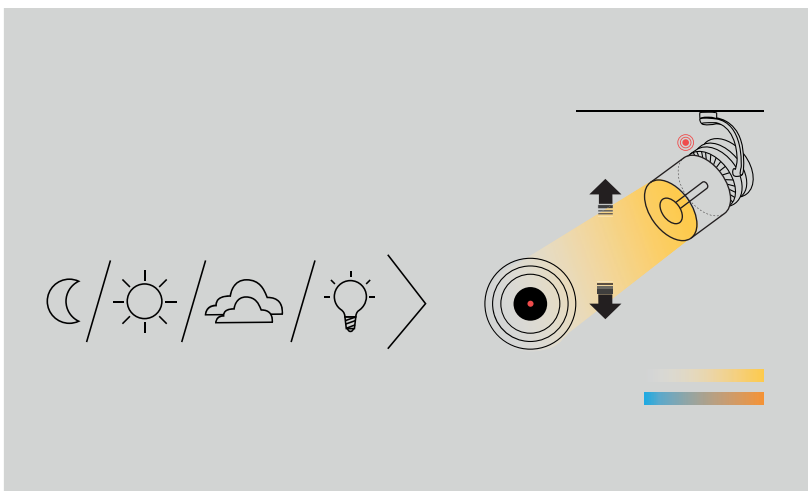

Artemide öffnet wichtige Forschungsthemen für Photonik und neue Technologien, um eine Zukunftsvision, eine neue Interpretationsart zu umreißen und Licht zu erleben. Artemide bewegt sich zu neuen Gestaltungsgrenzen, vom Atom zum Bit, bei der das Projekt nicht mehr der Mittelpunkt ist. Angefangen bei der zweifachen Konnotation von Licht als wellenförmiges und zugleich korpuskuläres Phänomen durchläuft die Neudefinition der Rolle und vom Potenzial des Lichts Konzepte, die über das Produkt hinausgehen zu neuen Steuerungszintelligenzen und Informationen. Heute muss die Vision eine bessere Alternative zu dem bieten, was wir bereits haben. Ein interaktives Design zwischen den technologischen Grenzen und der zeitgenössischen humanistischen Kultur, die in der Lage ist, Erfahrungen zu aktivieren und die Verhaltensweisen und Emotionen der Menschen aufzufangen. Internet of things gibt die Möglichkeit, neue Beziehungen und neue Formen des Bewusstseins und der Umweltkontrolle aufzubauen: Es ermöglicht, Projekte zu entwickeln, die auf eine dynamische und wechselseitige Erfahrung des Lichts im digitalen Dialog zu einem sozialen Licht gerichtet sind. Durch die technologischen Beschleunigungen gibt es viele Möglichkeiten. Die Zeit des technologischen Transfers, die zwischen Forschung und Anwendung verstreicht, verkürzt sich immer mehr. Dies hat für Artemide neue, konkrete Grenzen beim Projekt geöffnet: LiFi, intelligente und digitale Steuerungssysteme, bis zur Planung von realer Software wie LoT.

Artemide abre importantes temas de investigación sobre la fotónica y las nuevas tecnologías para delinear una visión futura, una nueva manera de interpretar y vivir la luz. Se mueve hacia nuevas fronteras del diseño, desde el átomo al bit, donde el producto en sí deja de ser el único elemento central. A partir de la doble connotación de la luz como fenómeno a la vez ondulatorio y corpuscular la redefinición del papel y de las potencialidades de la luz pasa a través de ideas que van más allá del producto, hacia nuevas inteligencias de gestión e información. Hoy en día los proyectos deben ofrecer una alternativa mejor a lo que ya tenemos, un diseño interactivo entre las fronteras tecnológicas y la cultura humanística contemporánea, capaz de activar experiencias e interpretar los comportamientos y las emociones de las personas. Internet of things (Internet de las cosas) da la posibilidad de generar relaciones y formas nuevas de conciencia y control del ambiente: permite desarrollar proyectos dirigidos a la experiencia dinámica e interactiva de la luz en un diálogo digital hacia una luz social. Las posibilidades que brinda esta aceleración tecnológica son muchas. El tiempo de la transferencia tecnológica, el que transcurre entre la investigación y la aplicación, es siempre más reducido. Esto ha abierto nuevas fronteras concretas de proyecto para Artemide: LiFi, sistemas de gestión inteligentes y digitales, hasta el proyecto verdaderos software como LoT.

Ameluna App

Ameluna App consente di vivere in modo totalmente nuovo il rapporto con la luce attraverso un'esperienza sorprendente, semplice ed intuitiva. Grazie ad un protocollo mesh BLE dotato di alti standard di sicurezza ci si può connettere ad Ameluna attraverso i vari mobile devices e creare, cambiare e richiamare varie scenografie di luce a seconda di ogni occasione scegliendo l'intensità luminosa della luce bianca e il colore.

Ameluna App

The Ameluna App enables an utterly new experience with light through a surprising, simple, and intuitive approach. A BLE mesh protocol based on high safety standards allows to connect with Ameluna using a variety of mobile devices, as well as to create, change, or set up different lighting scenarios matching every occasion and to choose the intensity of white light and colour.

Ameluna App

Ameluna App permet de vivre d'une manière tout à fait nouvelle le rapport avec la lumière par une expérience surprenante, simple et intuitive. Grâce à un protocole mesh BLE équipé de hauts standards de sécurité, on peut se connecter à Ameluna par les différents dispositifs mobiles et créer, changer et rappeler différentes scénographies de lumière selon chaque occasion et en choisissant l'intensité lumineuse de la lumière blanche et la couleur.

Ameluna App

Die Ameluna-App ermöglicht es, durch eine bezaubernde, einfache und intuitive Erfahrung eine ganz neue Art an Beziehung mit dem Licht zu erleben. Aufgrund von einem BLE-Mesh-Protokoll mit hohen Sicherheitsstandards kann sich über verschiedene mobile Geräte mit Ameluna verbunden werden, um entsprechend jeder Situation verschiedene Lichtszenarien zu erstellen, ändern und abzurufen, indem die Intensität des weißen und farbigen Lichts gewählt wird.

Ameluna App

Ameluna App permite vivir de una manera totalmente nueva la relación con la luz a través de una experiencia sorprendente, sencilla e intuitiva. Gracias a un protocolo mesh BLE con altos estándares de seguridad, es posible conectarse a Ameluna a través de diferentes dispositivos móviles y crear, cambiar y evocar una serie de escenografías de luz dependiendo de la ocasión, eligiendo la intensidad luminosa de la luz blanca y el color.

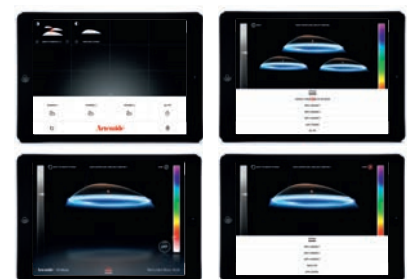

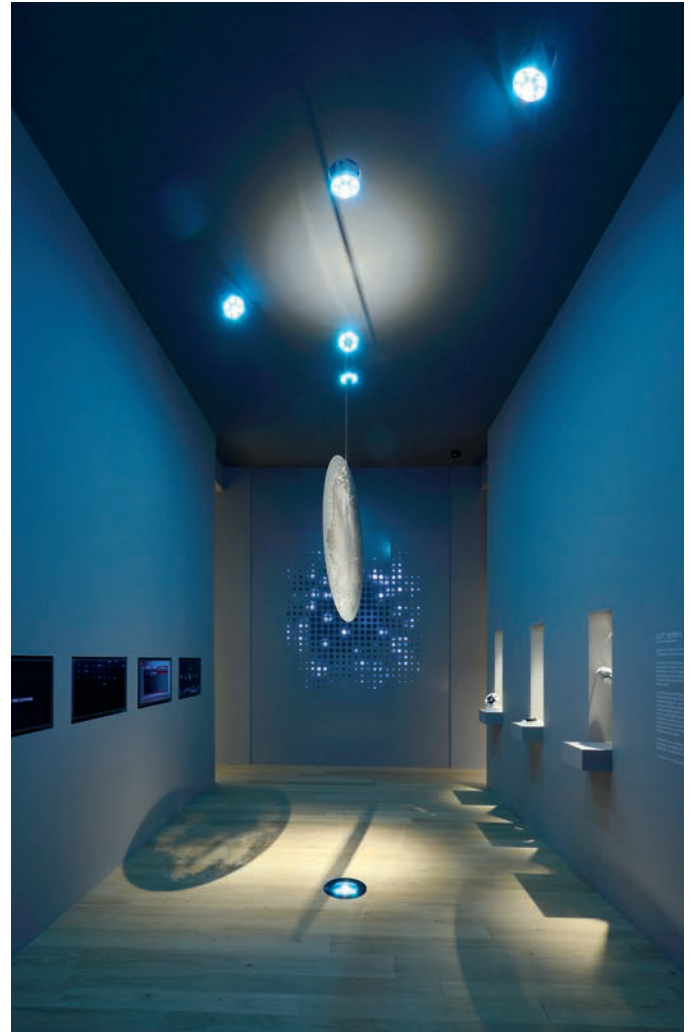

LoT Software

LoT introduce la variabile del tempo nella nostra esperienza della luce, attraverso la combinazione di un proiettore e un software consente di scegliere gli scenari di luce liberamente e in tempo reale. LoT software è il primo prodotto immateriale di Artemide, un'intelligenza innovativa di gestione che consente di valorizzare al massimo le potenzialità dei prodotti fisici rispondendo in modo più contemporaneo, esauriente e versatile ai bisogni progettuali ed applicativi.

LoT Software

LoT introduces the time variable into our experience with light through a combination of a projector and a software, which allows free and real-time choice of the lighting scenarios. The LoT software is the first intangible product of Artemide, an innovative management intelligence by which the potentials of physical products are maximized, while providing a more modern, exhaustive, and versatile response to design and application requirements.

LoT Software

LoT introduit la variable du temps dans notre expérience de la lumière par l'association d'un projecteur et un logiciel permet de choisir les scénarios de lumière librement et en temps réel. LoT software est le premier produit immatériel d'Artemide, une intelligence de gestion innovante qui permet de valoriser au maximum le potentiel des produits physiques en répondant d'une manière plus contemporaine, exhaustive et versatile aux besoins de conception et d'application.

LoT Software

LoT führt die Variable der Zeit in unsere Lichterfahrung ein. Durch die Kombination von einem Projektor und einer Software ermöglicht sie, Lichtszenarien frei und in Echtzeit auszuwählen. LoT-Software ist das erste immaterielle Produkt von Artemide, eine innovative Steuerungsintelligenz, die es ermöglicht, das Potenzial der physischen Produkte zu maximieren, indem zeitgemäßer, umfassender und vielseitiger auf die Gestaltungs- und Anwendungsanforderungen eingegangen wird.

LoT Software

LoT introduce la variable del tiempo en nuestra experiencia de la luz, a través de la combinación de un proyector y un software permite elegir los escenarios de luz libremente y en tiempo real. LoT software es el primer producto intangible de Artemide, una inteligencia de gestión innovadora que permite aprovechar al máximo las potencialidades de los productos físicos respondiendo de manera más contemporánea, exhaustiva y versátil a las necesidades de proyecto y de aplicación.

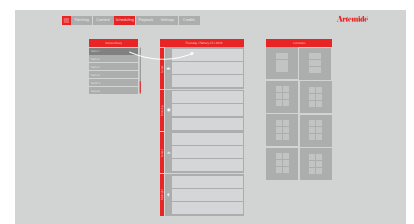
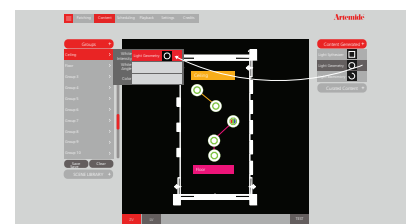
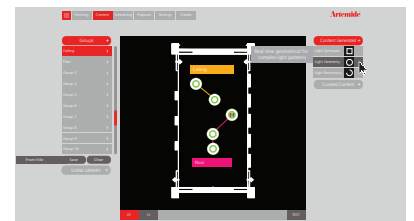

Atelier Oï Gae Aulenti	BIG Klaus Begasse Mario Botta	
Santiago Calatrava Livio Castiglioni David Chipperfield	Giovanni Giacobone Massimo Røj Progetto CMR	Carlotta de Bevilacqua Michele De Lucchi
Foster+Partners Carlo Forcolini Gianfranco Frattini Naoto Fukasawa	Adrien Gardère Ernesto Gismondi	Herzog & de Meuron
James Irvine Mikko Laakkonen	Arik Levy Ross Lovegrove Vico Magistretti Angelo Mangiarotti	EnzoMari Javier Mariscal
Guido Matta Enrico Girotti Giancarlo Mattioli Sergio Mazza	Alessandro Mendini Mercedes-Benz Style MiloDaMalo Issey Miyake	
Jean Nouvel	Mimmo Paladino Roberto Paoli Gio Ponti Neil Poulton	
Andrea Quaglio Manuela Simonelli Studio 63	Philippe Rahm Karim Rashid Aldo Rossi Italo Rota Alessandro Pedretti	
Richard Sapper Giuseppe Maurizio Scutellà Eric Solé Ettore Sottsass	Massimo Tassone Matteo Thun Pio & Tito Toso	
Luciano Vistosi	Jean Michel Wilmotte Scott Wilson	

The Designers.



Lampade da tavolo

Table lamps
Lampes de table
Tischleuchten
Lámparas de sobre-mesa



32

- 124 Castore
- 110 Choose
- 132 Dalù
- 134 Décomposé light
- 34 Demetra
- 34 Demetra micro
- 42 Demetra professional
- 126 Dioscuri
- 100 Eclittica 20 table
- 114 Empatia
- 72 Equilibrist
- 104 Fiamma
- 96 Halo
- 80 Ina
- 92 Ipparco
- 102 La Petite
- 112 Laguna
- 128 Logico table
- 128 Logico mini table
- 78 Lotek
- 106 Melampo
- 106 Melampo notte
- 120 Meteorite stem
- 122 Meteorite table
- 84 Objective
- 130 Onfale
- 88 Sisifo
- 74 Talak professional
- 66 Tizio
- 66 Tizio 35
- 66 Tizio micro
- 44 Tolomeo
- 60 Tolomeo basculante
- 62 Tolomeo mega table
- 44 Tolomeo micro
- 44 Tolomeo midi
- 44 Tolomeo mini
- 64 Unterlinden table

Lampade da terra

Floor lamps
Lampadaires
Stehleuchten
Lámparas de pie



136

- 142 Athena
- 174 Cabildo LED floor
- 150 Cadmo
- 188 Castore 35 floor
- 194 Choose floor
- 194 Choose mega floor
- 176 Cosmic Leaf
- 158 Décomposé light floor
- 168 Demetra reading floor
- 168 Demetra professional reading floor
- 184 Empatia 26 floor
- 164 Fiamma reading floor
- 166 Fiamma 15
- 138 Ilio
- 190 La Petite floor
- 156 Megaron LED
- 192 Melampo floor
- 192 Melampo mega floor
- 186 Meteorite 35 floor
- 154 Mimesi
- 146 New Nature
- 160 Reall
- 182 Reeds
- 152 Solium
- 172 Talak professional reading floor
- 170 Tizio floor support
- 198 Tolomeo basculante floor
- 198 Tolomeo basculante reading floor
- 196 Tolomeo floor
- 202 Tolomeo lampione outdoor
- 200 Tolomeo mega
- 196 Tolomeo micro floor
- 202 Tolomeo paralume outdoor
- 196 Tolomeo reading floor
- 208 Tolomeo XXL
- 178 Trix floor
- 180 Vigo reading floor

Lampade a sospensione

Suspension lamps
Suspensions
Pendelleuchten
Suspensiones



210

- 228 Alphabet of light circular
- 228 Alphabet of light linear
- 282 Altrove 600 LED susp.
- 278 Altrove LED susp.
- 216 Ameluna
- 216 Ameluna RGB
- 316 Cabildo LED
- 362 Calenda
- 344 Castore calice 18
- 342 Castore susp.
- 212 Chlorophyllia
- 214 Chlorophyllia 2
- 372 Choose susp.
- 372 Choose mega susp.
- 258 Copernico
- 262 Copernico 500
- 298 Cosmic Angel
- 306 Décomposé light susp.
- 234 Discovery
- 304 Eclittica 20
- 300 Eclittica 50
- 370 Edge
- 374 Eggboard
- 338 Empatia susp.
- 360 Empirico
- 360 Empirico system
- 272 Fiamma susp.
- 274 Fiamma 30
- 312 Float circolare
- 332 Incalmo
- 332 Incalmo 214
- 336 Invero
- 336 Invero 214
- 368 Lana
- 270 Led Net circle susp.
- 266 Led Net line susp.
- 384 Les Danseuses
- 356 Logico
- 356 Logico 3x120°
- 356 Logico 3 in linea
- 356 Logico mini
- 356 Logico mini 3x120°
- 356 Logico mini 3 in linea
- 296 Mercury
- 296 Mercury mini
- 340 Meteorite susp.
- 354 Miconos
- 308 Miyako
- 308 Miyako chandelier
- 366 Mouette simmetrica
- 366 Mouette asimmetrica

- 364 Nuboli
- 276 Null vector
- 288 Nur
- 288 Nur 1618
- 382 Nur Acoustic
- 294 Nur gloss
- 294 Nur gloss mini
- 288 Nur mini
- 242 Orsa 21
- 242 Orsa 35
- 244 Orsa chandelier 3
- 244 Orsa chandelier 5
- 250 Pirce
- 250 Pirce micro
- 250 Pirce mini
- 256 Scopas
- 378 Silent Fields
- 254 Space Cloud
- 238 Spectral Light
- 348 Stabligh
- 348 Stabligh A, B, C
- 314 Talo susp.
- 284 Tian Xia 500 LED
- 322 Tolomeo decentrata susp.
- 326 Tolomeo mega susp.
- 318 Tolomeo due bracci alluminio susp.
- 320 Tolomeo due bracci pergamena susp.
- 328 Tolomeo lampione hook outdoor
- 328 Tolomeo lampione hook outdoor
- 328 Tolomeo paralume hook outdoor
- 328 Tolomeo paralume susp. outdoor
- 246 Unterlinden
- 346 Vigo

Lampade da parete

Wall lamps
Appliques
Wandleuchten
Apliques



388

Lampade da soffitto

Ceiling lamps
Plafonniers
Deckenleuchten
Pláfonos



390

Masters' Pieces



542

IN-EI

ISSEY MIYAKE



590

392 Alphabet of light
498 Altrove 600 LED
496 Altrove LED
434 Cabildo LED wall
436 Cadmo LED wall
440 Choose wall
494 Crazy
426 Cuma
448 Demetra faretto
450 Demetra wall
450 Demetra micro wall
450 Demetra professional wall
432 Dinarco
490 Dioscuri wall/ceiling
400 Discovery wall
474 Droplet mini
478 Eclittica 20 wall/ceiling
500 Edge wall/ceiling
482 Empatia wall/ceiling
468 Febe
476 Fiamma wall/ceiling
406 Flashit
418 Islet
442 La Petite wall
444 Logico wall
444 Logico mini, Logico micro wall
438 Melampo wall
430 Melete
408 Mesmeri
486 Meteorite wall/ceiling
492 Miconos wall
422 Microsurf
502 Miyako wall/ceiling
472 Nebula
480 Orbiter
420 Pirce wall, Pirce micro wall
424 Rea
454 Talak professional wall
414 Talo
416 Talo 60/90/120/150
446 Teti
428 Tigia
462 Tolomeo basculante wall
456 Tolomeo braccio
458 Tolomeo faretto
464 Tolomeo mega wall
458 Tolomeo micro faretto
456 Tolomeo wall
456 Tolomeo micro, mini wall
460 Tolomeo pinza, micro pinza
466 Tolomeo diffusore wall
404 Vigo wall













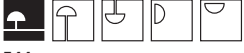



























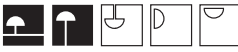



498 Altrove 600 LED
496 Altrove LED
540 Botanic rain
536 Cosmic Angel ceiling
494 Crazy
504 Décomposé light ceiling
490 Dioscuri wall/ceiling
474 Droplet mini
534 Droplet
478 Eclittica 20 wall/ceiling
500 Edge wall/ceiling
482 Empatia wall/ceiling
468 Febe
476 Fiamma wall/ceiling
506 Fiamma 15, 30 ceiling
514 Float circolare ceiling
512 Groupage
524 Incalmo ceiling
524 Incalmo 214 ceiling
522 Invero ceiling
522 Invero 214 ceiling
508 Iosif
520 Led Net circle
518 Led Net line
526 Logico ceiling
526 Logico micro ceiling
526 Logico mini ceiling
526 Logico 3x120° ceiling
526 Logico 3x120° mini ceiling
526 Logico 3x120° micro ceiling
538 Mercury ceiling
538 Mercury mini ceiling
486 Meteorite wall/ceiling
492 Miconos ceiling
502 Miyako wall/ceiling
472 Nebula
530 Nur gloss mini ceiling
528 Nur mini ceiling
480 Orbiter
516 Pirce ceiling
516 Pirce mini ceiling
532 Skydro
446 Teti
510 Trix





































































































































































574 Aggregato
574 Aggregato saliscendi
544 Alfa
556 Boalum
558 Callimaco LED
564 Chimera
566 Dulcinea
546 Eclisse
552 Fato
580 Hsiang
548 Lesbo
588 Metacolor LED
564 Mezzachimera
568 Montjuic
550 Nessino
550 Nesso
576 Noto
578 Pantalica
578 Pantalica wall
554 Patroclo
560 Pausania
570 Pipe LED wall/ceiling
570 Pipe LED
570 Pipe LED floor
582 Prometeo LED
562 Shogun
584 Yang



















































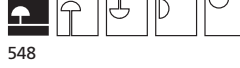

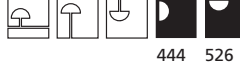

601 FUKUROU
596 MENDORI
596 MENDORI mini
602 MINOMUSHI floor
603 MINOMUSHI susp.
598 MOGURA mini
604 TATSUNO-OTOSHIGO
605 WUNI
600 YADOKARI







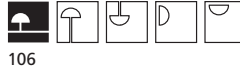

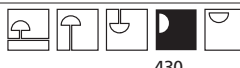



















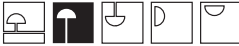













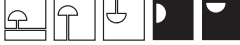









Indice alfabetico























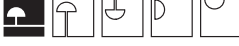









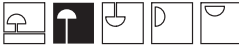

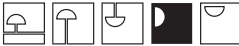







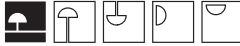



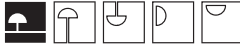

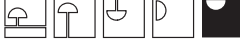

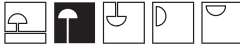





Alphabetical index
 Index par order alphabétique
 Alphabetisches Inhaltsverzeichnis
 Índice alfabético

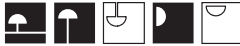









































































































































































	Aggregato		574
	Alfa		544
	Alphabet of light		392
	Alphabet of light circular		228
	Alphabet of light linear		228
	Altrove LED		278 496 496
	Altrove 600 LED		282 498 498
	Ameluna		216
	Athena		142
	Boalum		556 556
	Botanic rain		540
	Cabildo LED		174 316 434
	Cadmio LED		150 436
	Calenda		362
	Callimaco LED		558
	Castore		124 188 342
	Castore calice 18		344
	Chimera		564
	Mezzachimera		564 564
	Chlorophilia		212
	Chlorophilia 2		214
	Choose		110 194 372 440
	Choose mega		194 372
	Copernico		258
	Copernico 500		262
	Cosmic Angel		298 536
	Cosmic Leaf		176

	Crazy	    	494	494
	Cuma	    	426	
	Dalù	    	132	
	Decomposé light	    	134	158 306 504
	Demetra	    	34	168 450
	Demetra faretto	    	448	
	Demetra micro	    	34	450
	Demetra Professional	    	42	168 450
	Dinarco	    	432	
	Dioscuri	    	126	490 490
	Discovery	    	234	400
	Droplet	    	534	
	Droplet mini	    	474	474
	Dulcinea	    	566	
	Eclisse	    	546	
	Eclittica 20	    	100	304 478 478
	Eclittica 50	    	300	
	Edge	    	370	500 500
	Eggboard	    	374	
	Empatia	    	114	338 482 482
	Empatia 26	    	114	184 482 482
	Empirico	    	360	
	Empirico system	    	360	
	Equilibrat	    	72	
	Fato	    	552	
	Febe	    	468	468
	Fiamma	    	104	164 272 476 476
	Fiamma 15	    	166	506
	Fiamma 30	    	274	506

	Flashit		406
	Float circolare		312 514
	FUKUROU		601
	Groupage		512
	Halo		96
	Hsiang		580
	Ilio		138
	Ina		80
	Incalmo		332 524
	Incalmo 214		332 524
	Invero		336 522
	Invero 214		336 522
	Iosif		508
	Ipparco		92
	Islet		418
	La Petite		102 190 442
	Laguna		112
	Lana		368
	Led Net circle		270 520
	Led Net line		266 518
	Les Danseuses		384
	Lesbo		548
	Logico		128 356 444 526
	Logico micro		444 526
	Logico mini		128 356 444 526
	Logico 3 in linea		356
	Logico 3x120°		356 526
	Lotek		78
	Megaron LED		156
	Melampo		106 192 438
	Melampo mega floor		192
	Melampo notte		106
	Melete		430

	MENDORI		596
	MENDORI mini		596
	Mercury		296 538
	Mercury mini		296 538
	Mesmeri		408
	Metacolor LED		588
	Meteorite		120 186 340 486 486
	Meteorite stem		122
	Miconos		354 492 492
	Microsurf		422
	Mimesi		154
	MINOMUSHI		602 603
	Miyako		308 502 502
	Miyako chandelier		308
	MOGURA mini		598
	Montjuic		568
	Mouette asimmetrica		366
	Mouette simmetrica		366
	Nebula		472 472
	Nesso		550
	Nessino		550
	New Nature		146
	Noto		576
	Nuboli		364
	Null vector		276
	Nur		288
	Nur mini		288 528
	Nur 1618		288
	Nur Acoustic		382
	Nur gloss		294
	Nur gloss mini		294 530

	Objective		84
	Onfale		130
	Orbiter		480 480
	Orsa		242
	Orsa chandelier 3		244
	Pantalica		578 578
	Patroclo		554
	Pausania		560
	Pipe LED		570 570 570 570
	Pirce		250 420 516
	Pirce micro		250 420
	Pirce mini		250 516
	Prometeo LED		582
	Rea		424
	Reall		160
	Reeds		182
	Scopas		256
	Shogun		562
	Silent Field		378
	Sisifo		88
	Skydro		532
	Solium		152
	Space Cloud		254
	Spectral Light		238
	Stabligh		348
	Stabligh A, B, C		348
	Talak professional		74 172 454
	Talo		414
	Talo 60/90/120/150		314 416
	TATSUNO-OTOSHIGO		604
	Teti		446 446

	Tian Xia 500 LED	    	284		Tolomeo lampione outdoor	    	202 328
	Tigia	    	428				
	Tizio	    	66		Tolomeo mega	    	62 200 326 464
	Tizio 35	    	66				
	Tizio floor support	    	170		Tolomeo paralume outdoor	    	202 328
	Tizio micro	    	66				
	Tolomeo	    	44 196 456		Tolomeo pinza	    	460
	Tolomeo micro	    	44 196 456				
	Tolomeo midi	    	44		Tolomeo reading floor	    	196
578	Tolomeo mini	    	44 456				
	Tolomeo basculante	    	60 198 462		Tolomeo XXL	    	208
	Tolomeo braccio	    	456				
	Tolomeo decentrata susp.	    	322		Trix	    	178 510
	Tolomeo diffusore wall	    	466		Unterlinden	    	64 246
	Tolomeo due bracci alluminio susp.	    	318		Vigo	    	180 346 404
	Tolomeo due bracci pergamena susp.	    	320		WUNI	    	605
	Tolomeo faretto	    	458		YADOKARI	    	600
	Tolomeo micro faretto	    	458		Yang	    	584

Lampade da tavolo

Table lamps
Lampes de table
Tischleuchten
Lámparas de sobremesa



34
Demetra
Demetra micro



42
Demetra
Demetra professional



44
Tolomeo
Tolomeo mini
Tolomeo midi
Tolomeo micro



60
Tolomeo
basculante



88
Sisifo



92
Ipparco



96
Halo



100
Eclittica 20 table



124
Castore



126
Dioscuri



128
Logico table
Logico mini table



130
Onfale



62
Tolomeo mega
table



64
Unterlinden
table



66
Tizio
Tizio 35
Tizio micro



72
Equilibrist



74
Talak professional



78
Lotek



80
Ina



84
Objective



102
La Petite



104
Fiamma



106
Melampo
Melampo notte



110
Choose



112
Laguna



114
Empatia



120
Meteorite



122
Meteorite stem



132
Dalù



134
Decomposé light

Demetra
Demetra micro

Naoto Fukasawa
2012

Awards

2014 – Reddot Design Award
Essen (Deutschland)
2014 – iF Product Design Award
Deutschland
2014 – Design Plus Light+Building Award
Frankfurt am Main (Deutschland)



Serie di lampade da tavolo (con gli accessori morsetto e perno fisso), lettura, parete e faretto. Disponibile oltre alla versione tradizionale e MD anche nella versione Micro e Professional.

A selection of table lamps (with table base, clamp and fixed support), also available in the reading, wall and spot versions. Available in the traditional, MD, as well as Micro and Professional version.

Il s'agit d'une série de lampes de table comprenant différents accessoires : étau ou pivot, d'une liseuse, d'une applique et spot. Disponible dans la version traditionnelle, MD et également dans la version Micro et Professional.

Leuchtenfamilie bestehend aus Tischleuchten (mit Tischklemme oder Schraubbefestigung als Zubehör), Leseleuchte, Wandleuchte und Wandstrahler. Erhältlich in der traditionellen Version, als MD, sowie in der Micro- und Professional-Version.

Serie de lámparas de sobremesa (con los accesorios mordaza y perno fijo), lectura, pared y faretto. Disponible en la versión tradicional, MD y también en la versión Micro y Professional.

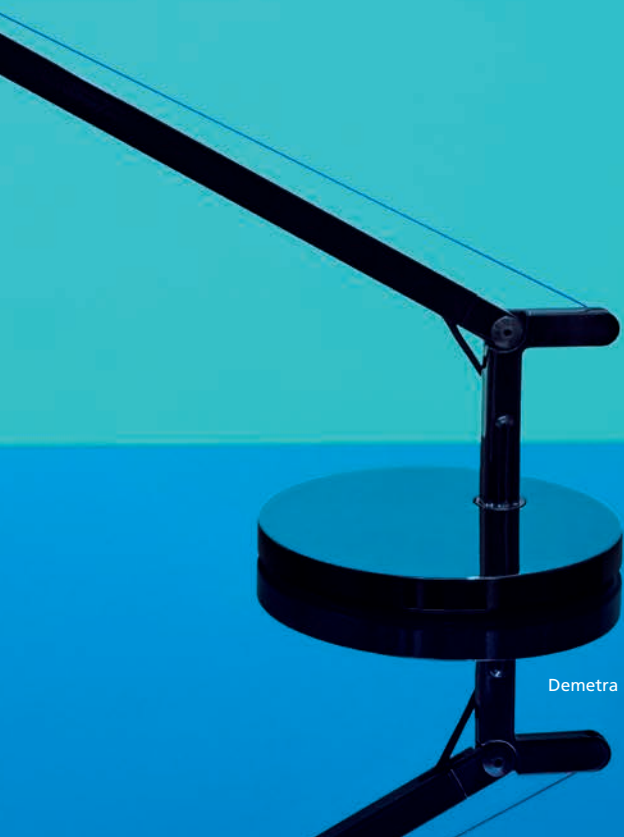

Demetra

Light emission



Colours

Demetra



Demetra micro

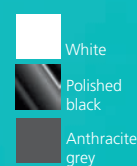



Demetra white

Demetra polished black



Demetra micro white

Demetra micro anthracite grey

Demetra anthracite grey



Photo by Elliott Erwitt, 2014

Materiali

Base in acciaio e testa in alluminio pressofuso verniciato, bracci in alluminio estruso, snodi in pressofusione di alluminio.

Demetra MD

In questa versione è presente un sensore Movement detector, che gestisce l'accensione dell'apparecchio a seconda della vicinanza dell'utente.

Demetra Micro

Nelle versioni tavolo e parete, mantiene tutti i gradi di libertà presenti nella versione tradizionale, quindi la massima flessibilità di direzionare la luce nello spazio. Gli snodi della versione micro sono in tecnopolimero stampato a iniezione.

Materials

Steel Painted base and die-cast aluminium head, aluminium extruded arms, die-cast aluminum junctions.

Demetra MD

This table model features a Movement detector option detecting moving objects and people and turning the light on or off accordingly.

Demetra Micro

In the table and wall version with arm, is smaller than Demetra and ensures maximum flexibility to adjust light in space. The micro version has injection-moulded engineering-plastics junctions.

Matériaux

Base en acier et tête en aluminium moulé sous pression verni, bras en aluminium extrudé, articulations en fonte d'aluminium.

Demetra MD

Cette version est dotée d'un détecteur de mouvement qui gère l'allumage de l'appareil selon la présence ou non de l'utilisateur.

Demetra Micro

Dans les versions de table et murale à un bras, présente, dans une taille plus réduite par rapport à Demetra, la plus grande flexibilité pour diriger la lumière dans l'espace. Les bras de la version micro sont en technopolymère moulé par injection.

Materialien

Leuchtenbasis und -kopf aus lackiertem Aluminiumguss, Leuchtenarme aus extrudiertem Aluminium, Gelenke aus formgestanztem Aluminium.

Demetra MD

Diese Version der Tischleuchte ist mit einem Bewegungsmelder ausgestattet.

Demetra Micro

Zeigt in den Tisch- und Wandversionen mit Arm mit einer geringeren Größe als Demetra höchste Flexibilität, das Licht im Raum auszurichten. Die Gelenke der Micro-Version sind aus Spritzguss-Technopolymer.

Materiales

Base de acero y cabezal de aluminio fundido a presión pintado, brazos de aluminio extruido, articulaciones en presofusión de aluminio.

Demetra MD

En esta versión existe un sensor de detección de Movimiento: que gestiona el encendido del aparato según la proximidad del individuo.

Demetra Micro

En las versiones de sobremesa y aplique de pared mantiene todos los grados de libertad presentes en la versión tradicional, ofreciendo la máxima flexibilidad para dirigir la luz en el espacio. Las articulaciones de la versión micro son de tecnopolímero moldeado por inyección.

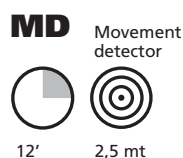



Demetra clamp version



Demetra desk fixed support version

Demetra professional

Naoto Fukasawa
2016

In Demetra Professional le dimensioni si mantengono identiche alla versione classica ma il maggiore flusso emesso consente di ottenere illuminamenti elevati sul piano di lavoro. L'emissione è controllata da un riflettore che sporge leggermente dal profilo della testa.

Materiali

Base in acciaio e testa in alluminio pressofuso verniciato, bracci in alluminio estruso, snodi in pressofusione di alluminio.

While the size of Demetra Professional is the same as the classical version's, its enhanced emission flow provides intense lighting on the worktop. Emission is controlled by a reflector that slightly protrudes from the head's profile.

Materials

Steel base and painted die-cast aluminium head, aluminium extruded arms, die-cast aluminium junctions.

En ce qui concerne Demetra Professional, la taille est toujours identique à la version classique mais le débit de lumière plus fort permet d'obtenir un éclairage élevé sur le plan de travail. L'émission est contrôlée par un réflecteur qui dépasse légèrement du profil de la tête.

Matériaux

Base en acier et tête en aluminium moulé sous pression verni, bras en aluminium extrudé, articulations en aluminium moulé sous pression.

Bei Demetra Professional sind die Maße die gleichen der klassischen Version, aber der größere emittierte Lichtstrom ermöglicht es, auf der Arbeitsfläche eine höhere Beleuchtungsstärke zu erhalten. Die Lichtemission wird von einem Scheinwerfer kontrolliert, der leicht aus dem Profil des Leuchtenkopfes ragt.

Materialien

Leuchtenbasis aus Stahl und -kopf aus lackiertem Aluminiumguss, Leuchtenarme aus extrudiertem Aluminium, Gelenke aus druckgegossenem Aluminium.

Demetra Professional tiene en mismo tamaño que la versión clásica pero el mayor flujo emitido permite obtener iluminaciones altas en la superficie de trabajo. La emisión es controlada por un reflector que sale ligeramente del perfil del cabezal.

Materiales

Base de acero y cabezal de aluminio fundido a presión pintado, brazos de aluminio extruido, articulaciones de aluminio fundido a presión.



Light emission



Colours



White



Polished
black



Anthracite
grey



Tolomeo
Tolomeo mini
Tolomeo midi
Tolomeo micro

Michele De Lucchi
Giancarlo Fassina
1987



Patent Pending

n. 11161968.0

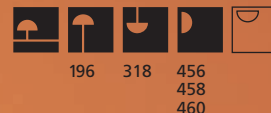

LED

LED

Serie di lampade da tavolo, terra, parete e sospensione disponibili in diverse dimensioni, con diverse sorgenti e finiture.

Materiali

Base in acciaio rivestita di alluminio, struttura e diffusore in alluminio.

Tolomeo tavolo

Supporto intercambiabile: base, morsetto, perno fisso. Sistema di equilibratura a molle.

Range of table, floor, wall and suspension lamps available in several dimensions, with different light sources and finishings.

Materials

Aluminium-coated steel base; aluminium frame and diffuser.

Tolomeo tavolo

Interchangeable support: table base, clamp, desk fixed support. System of spring balancing.

Série de lampes de table, lampadaires, appliques et suspensions disponibles en différentes couleurs et dimensions.

Matériaux

Base en acier revêtue d'aluminium : structure et diffuseur en aluminium.

Tolomeo tavolo

Le corps de la lampe peut être associé à une base, à un étau, à un pivot. Système d'équilibrage à ressorts.

Leuchtenfamilie bestehend aus Tischleuchten, Stehleuchten, Wandleuchten und Pendelleuchten. Erhältlich in verschiedenen Größen, unterschiedlichen Bestückungen und Oberflächen.

Materialien

Die Stahlbasis ist mit Aluminium beschichtet; die Leuchtenstruktur und der Diffusor sind aus Aluminium.

Tolomeo tavolo

Auswechselbare Befestigungen: Tischfuß, Klemme, Schraubbefestigung. Mit Federausgleichsystem.

Serie de lámparas de mesa, de pie, apliques y suspensión; disponibles en distintas dimensiones, con diferentes fuentes de luz y acabados.

Materiales

Base de acero revestida de aluminio; estructura y difusor de aluminio.

Tolomeo tavolo

Soporte intercambiabile: base de sobremesa, mordaza, perno fijo para escritorio. Sistema de equilibrado a muelles.

Awards

1989 – Compasso d'Oro / A.D.I. Milano (Italia)

1987 – SNAI Oscar des Architectes d'Intérieur Paris (France)

1987 – Haus Industrieform Deutschland Tolomeo fluo

2008 – Designpreis der Bundesrepublik Deutschland, Nominierung

Tolomeo micro

2001 – Observateur du design Produit sélectionné – A.P.C.I. Paris (France)

Museum

Itinerario Storico Permanente Museo Nazionale della Scienza e della Tecnica Leonardo da Vinci Milano (Italia)

Sezione Design Civica Galleria d'Arte Moderna Gallarate (Italia)

The Israel Museum – Jerusalem (Israel)

Musée des Arts Décoratifs de Montréal Montréal (Canada)

Museo Permanente del Design Italiano 1945/1990 – Triennale di Milano Milano (Italia)

Galleria d'Arte Moderna – Roma (Italia)



Tolomeo mini

Tolomeo micro



Tolomeo midi



Tolomeo

Light emission



Tolomeo LED,
LED **MD**, Led **TW**



Metal grey

Tolomeo Halo



Metal grey



Black



White

Tolomeo mini LED,
LED **MD**, Led **TW**



Metal grey

Tolomeo mini Halo



Metal grey



Black



White

Tolomeo midi LED



Metal grey



Anthracite grey

Tolomeo micro LED



Metal grey

Tolomeo micro Halo



Metal grey



Black



Metal orange



Metal blue



Metal red



Polished white



Gold



Desk fixed support



Clamp



Table base



Photo by Elliott Erwit, 2014

LED technology

Utilizzando la tecnologia LED l'attenzione va posta non solo al consumo di energia e all'efficienza luminosa, ma soprattutto alla qualità e quantità della distribuzione della luce. Infatti il vantaggio del Led è che emette il 100% di flusso luminoso nell'emisfero diretto, annullando dispersioni e sprechi in altre direzioni. Questo significa che per ottenere sul piano di lavoro un illuminamento di 1250lux, con una sorgente incandescente è necessaria una potenza di 100W, mentre con una sorgente Led sono sufficienti 10W, con un risparmio del 90% di energia elettrica.

Using LED technology, the attention must be focused not only on energy consumption and light efficiency, but above all on the quality and quantity of the distribution of the light. In fact the advantage of the Led is that it emits 100% light flow into the direct hemisphere, eliminating dispersion and waste in other directions. This means that in order to obtain illuminance of 1250 lux on the work surface, with an incandescent light source a power of 100W is necessary, while with a Led source 10W is sufficient, with a 90% energy saving.

En utilisant la technologie LED, on prête l'attention non seulement à la consommation d'énergie et à l'efficacité lumineuse, mais aussi et surtout à la qualité et la quantité de la distribution de la lumière. En effet, l'avantage de la Led est qu'elle émet 100% du flux lumineux d'hémisphère direct, en annulant ainsi les dispersions et les gâchis dans les autres directions. Cela signifie que, pour obtenir sur le plan de travail, un éclairage de 1250 lux, avec une source à incandescence, il est nécessaire d'avoir une puissance de 100W, tandis que 10W suffisent avec une source Led, soit 90% d'économie d'énergie électrique.

Led zeichnen sich durch einen stark reduzierten Energieverbrauch, eine lange Lebensdauer und eine optimale Lichtausbeute aus. Bei LED-Leuchten wird das Licht zu 100% direkt in die Umgebung abgegeben, so dass Energievergeudung und Lichtemission in andere Richtungen ausgeschlossen werden können. So ist beispielsweise zur Ausleuchtung einer Arbeitsfläche mit 1.250 Lux bei Einsatz einer Glühlampe eine Leistung von 100W erforderlich, wo hingegen eine Led-Leuchte lediglich 10W benötigt. Hierdurch wird eine Energieeinsparung von 90% erzielt.

Utilizando la tecnología LED la atención se centra no sólo en el consumo de energía y en la eficiencia luminosa, sino sobre todo en la calidad y cantidad de la distribución de la luz. En efecto la ventaja del Led es que emite el 100% de flujo luminoso en el hemisferio directo, anulando dispersiones y despilfarros en otras direcciones. Esto significa que para obtener en el plano de trabajo una iluminación de 1250lux, con una fuente incandescente se necesita una potencia de 100W, mientras con una fuente Led bastan 10W, con un ahorro del 90% de la energía eléctrica.

Horizontal illuminance h 40cm

Tolomeo LED 10,2W

illuminance med. 1107 lux
illuminance min. 716 lux
illuminance max. 1452 lux

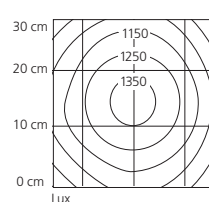

Tolomeo HALO 100W

illuminance med. 1329 lux
illuminance min. 947 lux
illuminance max. 1684 lux

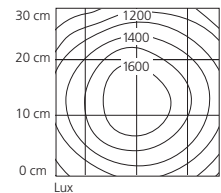





Photo by Elliott Erwit, 2014

Nella versione Tolomeo LED e Tolomeo mini LED è presente un sensore Movement detector, che gestisce l'accensione dell'apparecchio a seconda della vicinanza dell'utente.

Tolomeo LED and Tolomeo mini LED features a Movement detector option detecting moving objects and people and turning the light on or off accordingly.

La version Tolomeo LED et la version Tolomeo mini LED sont dotées d'un détecteur de mouvement qui gère l'allumage de l'appareil selon la présence ou non de l'utilisateur.

Der Version Tolomeo LED und Tolomeo mini LED der Tischleuchte ist mit einem Bewegungsmelder ausgestattet.

En la versión Tolomeo LED y Tolomeo mini LED existe un sensor de detección de Movimiento: que gestiona el encendido del aparato según la proximidad del individuo.

MD Movement detector



12°



2,5 mt

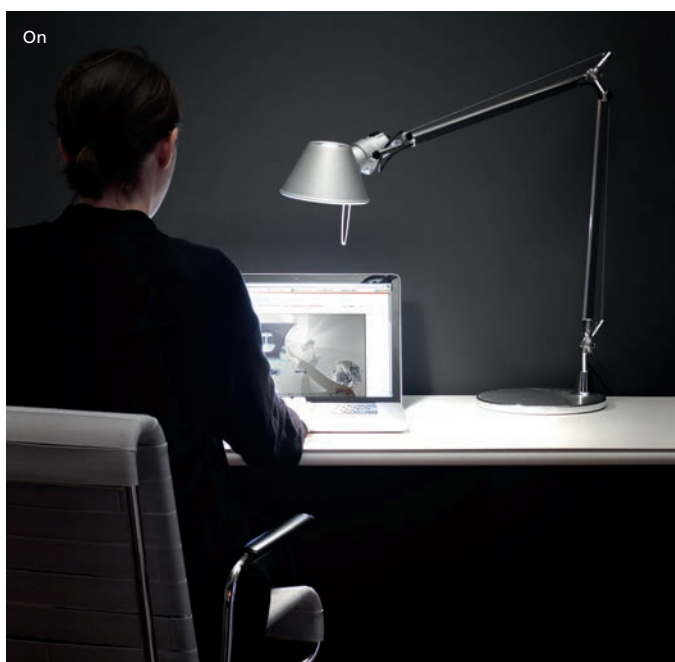
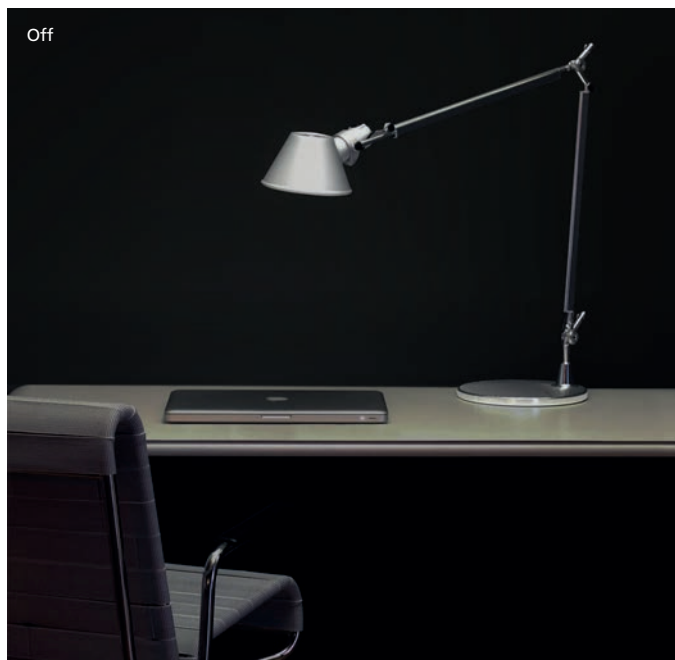

TW Tunable White

Tolomeo Tunable White coniuga i vantaggi della tecnologia LED e quelli della tecnologia Tunable White, consentendo di ottenere numerose declinazioni della luce bianca, nelle sue diverse intensità e varietà di temperature di colore, con un'escursione da 2.300K (luce calda) a 10.000K (luce fredda).

Tolomeo Tunable White combines the advantages of LED technology with those of Tunable White technology, enabling numerous variations of white light to be obtained, with different intensities and varieties of colour temperature, with a range from 2,300K (warm light) to 10,000K (cold light).

Tolomeo Tunable White allie les avantages de la technologie LED à ceux de la technologie Tunable White, ce qui permet d'obtenir de nombreuses déclinaisons de lumière blanche, dans les différentes intensités et variétés de températures de couleur, avec une amplitude allant de 2.300K (lumière chaude) à 10.000K (lumière froide).

Tolomeo Tunable White verbindet die Vorteile der Led-Technologie mit denen des "Tunable White"-systems, das eine ausgesprochen breite Palette der Abgabe von Weißlicht in verschiedenen Lichtstärken und Farbtemperaturen ermöglicht; die Farbtemperatur beträgt 2.300K bei Warmlicht bzw. 10.000K bei Kaltlicht.

Tolomeo Tunable White conjuga las ventajas de la tecnología Led con las de la tecnología Tunable White, y permite obtener numerosas gamas de luz blanca, en sus diversas intensidades y variedades de temperatura de color, con una variación de 2.300K (luz cálida) a 10.000K (luz fría).



2300 K

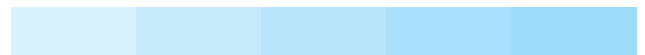

10000 K







Tolomeo micro



Tolomeo micro, photo by Elliott Erwitt, 2001



Tolomeo micro gold, photo by Pierpaolo Ferrari, 2016



Tolomeo basculante

Michele De Lucchi
Giancarlo Fassina
2004

Materiali

Base in acciaio con rivestimento in alluminio e struttura a bracci mobili in alluminio lucidato; diffusore in carta pergamena o in raso di seta supportato da materiale plastico; snodi in alluminio brillantato.

Specificità

Supporto intercambiabile: base, morsetto, perno fisso. Il diffusore nel normale utilizzo, si dispone verticalmente, indipendentemente dall'angolazione del braccio. Sistema di equilibratura a molle.

Materials

Aluminium-coated steel base and cantilevered arms in polished aluminium; diffuser in parchment paper or in silk satin fabric on a plastic frame; joints in polished aluminium.

Specification

Interchangeable support: table base, clamp, desk fixed support. The diffuser normally used, remains vertical regardless of the angle of the arm. System of spring balancing.

Matériaux

Base en acier revêtue d'aluminium et structure à bras articulés en aluminium poli; diffuseur en papier parchemin ou en polycarbonate recouvert de satin de soie ; articulations en aluminium brillant.

Spécificité

Le corps de la lampe peut être associé à une base, à un étau. Le diffuseur dans le cadre d'une utilisation normale, se place verticalement, indépendamment de la position du bras. Système d'équilibrage à ressorts.

Materialien

Die Stahlbasis ist mit Aluminium beschichtet und ausrichtbare Arme aus glänzendem Aluminium; Schirm aus mit Kunststoff stabilisiertem Pergamentpapier oder Seidensatin; Gelenke aus poliertem Aluminium.

Spezifikation

Auswechselbare Befestigungen: Tischfuß, Klemme, Schraubbefestigung. Mit Federausgleichsystem.

Materiales

Base de acero revestida de aluminio y estructura con brazos móviles de aluminio pulido; difusor en pergamino o en raso seda reforzado con plástico; articulaciones de aluminio pulido.

Especificaciones

Soporte intercambiable: base de sobremesa, mordaza, perno fijo para escritorio. En su uso normal, el difusor se dispone verticalmente, independientemente de la inclinación del brazo. Sistema de equilibrado a muelles.



Table base



Desk fixed support



Clamp

Light emission



Colours

- Clamp and arms:
Metal grey
- Diffuser:
Natural
- Diffuser:
Grey



Tolomeo mega table

Michele De Lucchi
Giancarlo Fassina
2003

Materiali

Base in acciaio con rivestimento in alluminio, struttura a bracci mobili in alluminio lucidato; diffusore in carta pergamena, in raso di seta o in tessuto nero supportato da materiale plastico; snodi e morsetto in alluminio brillantato.

Specificità

Diffusore disponibile in tre dimensioni, orientabile in tutte le direzioni. Sistema di equilibratura a molle.

Materials

Aluminium-coated steel base, cantilevered arms in polished aluminium; diffuser in parchment paper, in silk satin or in black fabric on a plastic frame; joints and clamp in polished aluminium.

Specification

Diffuser, available in three sizes, adjustable in all directions. System of spring balancing.

Matériaux

Base en acier revêtue d'aluminium, structure à bras articulés en aluminium poli ; diffuseur en papier parchemin, en polycarbonate ou en tissu noir recouvert de satin de soie ; articulations et étau en aluminium brillant.

Spécificité

Diffuseur disponible en trois tailles, orientable dans toutes les directions. Système d'équilibrage à ressorts.

Materialien

Die Stahlbasis ist mit Aluminium beschichtet, Ausrichtbare Arme aus glänzendem Aluminium; Schirm aus mit Kunststoff stabilisiertem Pergamentpapier, Seidensatin oder Gewebe schwarz Gelenke und Klemme aus poliertem Aluminium.

Spezifikation

Der Leuchtenkopf, in drei Größen erhältlich, ist in alle Richtungen verstellbar. Federausgleichsystem.

Materiales

Base de acero revestida de aluminio, estructura con brazos móviles de aluminio pulido; difusor en pergamino, en raso seda o en tejido negro reforzado con plástico; articulaciones y mordaza de aluminio pulido.

Especificaciones

Difusor disponible en tres tamaños, orientable en todas direcciones. Sistema de equilibrado a muelles.



Desk fixed support



Clamp

Light emission



Colours

- Clamp and arms: Metal grey
- Diffuser: Natural
- Diffuser: Grey
- Diffuser: Black

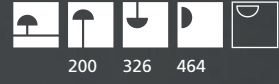

200 326 464

LED

LED



Materiali

Corpo lampada realizzato con una pressofusione di alluminio o ottone; base in pressofusione di zama e stelo in acciaio.

Specificità

La sorgente luminosa è un LED COB; il flusso luminoso è controllato anche da una lente in polimero ad alta efficienza ottica studiata appositamente per concentrare il fascio luminoso.

Materials

Lamp body in die-cast aluminium or brass; die-cast zamac base and steel stem.

Specification

The light source is a COB LED to ensure a maximum luminous efficiency. The light beam is also controlled by a high-efficiency optic polymeric lens especially designed to collimate light.

Matériaux

Corps réalisé en aluminium ou cuivre ; base en zama moulé sous pression et tige en acier.

Spécificités

La source lumineuse est une LED COB ; le flux lumineux est aussi contrôlé par une lentille en polymère à haute efficacité optique étudiée pour concentrer le faisceau lumineux.

Materialien

Leuchtenkörper hergestellt aus Aluminium- oder Messing; Die Basis ist aus Druckguss einer Zamak-Legierung und der Leuchtenstab aus Stahl.

Spezifikation

Eine COB-LED fungiert als Lichtquelle, um maximalen Wirkungsgrad und niedrige Energiekosten zu gewährleisten. Die speziell entwickelte Linse aus Polymer ermöglicht optische Effizienz und einen konzentrierten Lichtstrahl.

Materiales

Cuerpo lámpara realizado con una fundición de aluminio y latón; base de fundición a presión de zamak y pie de acero.

Especificaciones

La fuente de luz es un LED COB; el flujo luminoso está controlado por una lente en polímero de alta eficiencia óptica estudiada a propósito para concentrar el haz luminoso.





LED

246



Light emission



Colours



Brass



Aluminium

Tizio
Tizio 35
Tizio micro

Richard Sapper
1972





170

LED

LED



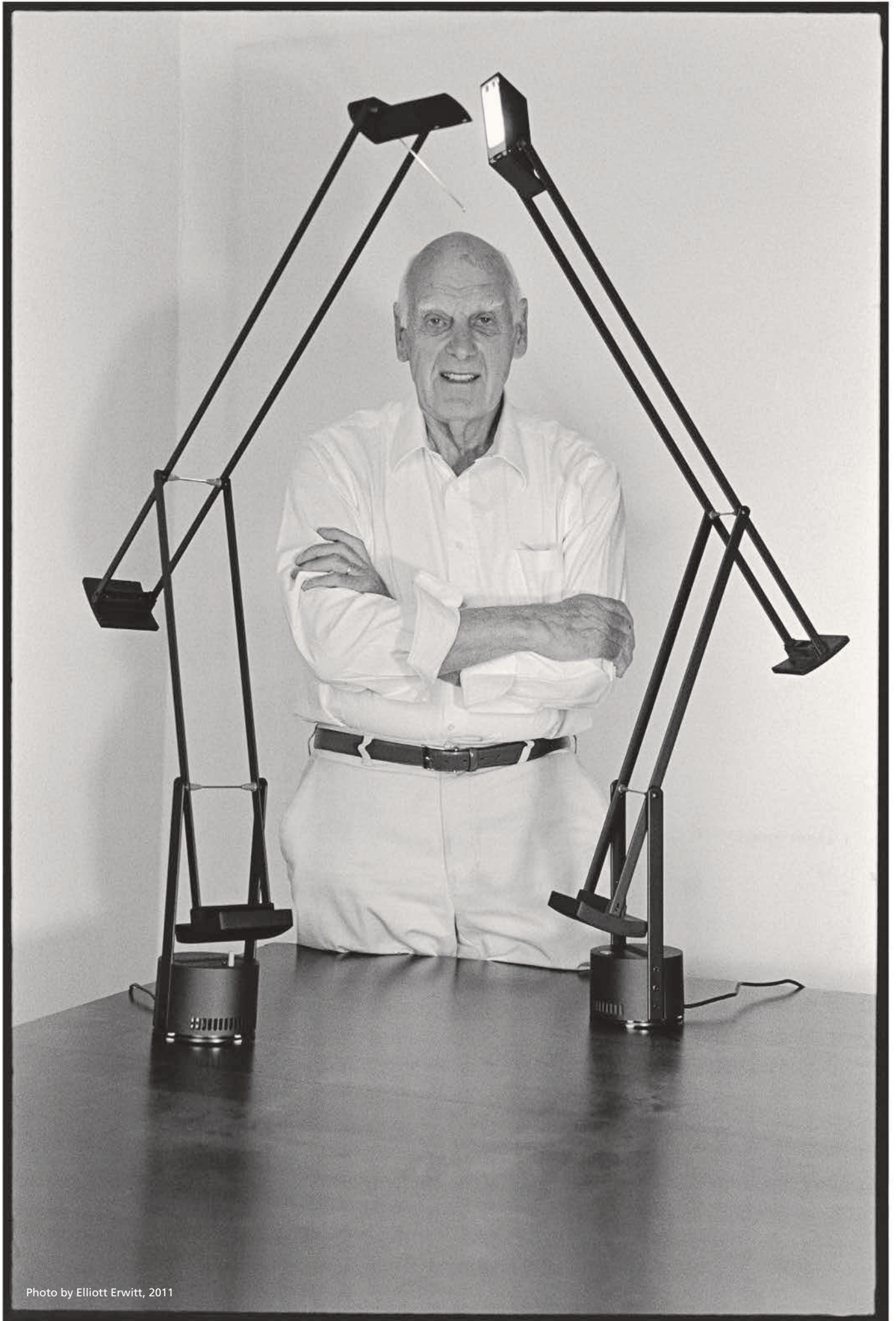

Photo by Elliott Erwitt, 2011

Serie di lampade disponibili in diverse dimensioni.

Materiali

Copertura base in tecnopolimero verniciato, aste in alluminio estruso, contrappesi in ottone; testa Tizio Halo in tecnopolimero verniciato; testa Tizio LED in alluminio pressofuso.

Specificità

Testa e bracci orientabili bilanciati da contrappesi.

Range of lamps available in several dimensions.

Materials

Painted engineering-plastics base coating, aluminium extruded shafts, brass counterweights; Tizio Halo head: painted engineering-plastics; Tizio LED head: die-cast aluminium.

Specification

Adjustable counterbalanced arms and head.

Série de lampes disponibles en différentes dimensions.

Matériaux

Couverture de la base en technopolymère verni, tiges en aluminium extrudé, contrepoids en laiton ; tête Tizio Halo en technopolymère verni ; tête Tizio LED en aluminium moulé sous pression.

Spécificité

Bras articulés et tête orientable, l'ensemble est équilibré par contrepoids.

Leuchtenfamilie, erhältlich in verschiedenen Größen und Bestückungen.

Materialien

Die Basisabdeckung ist aus lackiertem Technopolymer, die Stangen aus extrudiertem Aluminium und die Gegengewichte aus Messing; der Leuchtenkopf Tizio Halo ist aus lackiertem Technopolymer; der Leuchtenkopf Tizio LED aus Aluminiumguss.

Spezifikation

Ausrichtbare Arme und Leuchtenkopf.

Serie de lámparas disponibles en distintas imensiones.

Materiales

Cobertura base de tecnopolímero pintado, varilla de aluminio extruido, contrapesos de latón; cabeza Tizio Halo de tecnopolímero pintada; cabeza Tizio LED de aluminio fundido a presión.

Especificaciones

Brazos y cabezal orientables, compensados mediante contrapesos.

Awards

Tizio

1979 – Compasso D'Oro / A.D.I. Segnalazione - Milano (Italia)

1973 – Casamica – Per l'accessorio Milano (Italia)

1981 – BIO 9 – Gold Medal Ljubljana (Slovenia)

1980 – Haus Industrieform Design Zentrum Nordrhein Westfalen Essen (Deutschland)

Museum

Tizio

Twentieth Century Design Collection of the Metropolitan Museum of Art New York (USA)

Design Collection of the Museum of Modern Art – New York (USA)

Itinerario Storico Permanente Museo Nazionale della Scienza e della Tecnica Leonardo da Vinci Milano (Italia)

Sezione Design Civica Galleria d'Arte Moderna Gallarate (Italia)

Collection "Design since 1945" Philadelphia Museum of Art Philadelphia (USA)

Museum Rufino Tamayo Mexico City (Mexico)

Victoria and Albert Museum London (United Kingdom)

The Denver Art Museum Denver Colorado (USA)

The Israel Museum Jerusalem (Israel)

Musée des Arts Décoratifs de Montréal Montréal (Canada)

Museo Permanente del Design Italiano 1945-1990 – Triennale di Milano Milano (Italia)

Brooklyn Museum of Art New York (USA)

Light emission



Colour



Black



Tizio LED



Tizio micro, photo by Elliott Erwitt, 2001

Materiali

Alluminio; contrappeso della base in zama.

Specificità

Lampada da tavolo con due distinte e contrapposte sorgenti LED da 3W (della testa rotonda) e 9W (della testa quadrata), collocate alle estremità di un braccio a bilanciere. La corrente si trasmette, attraverso i due profili dello stelo centrale, al braccio a bilanciere, alimentando le due teste, che in un continuo saliscendi rimangono in un costante equilibrio dinamico.

Materiali

Aluminium; counterweight with a zamac base.

Specification

Table lamp with two distinct and opposed 3W (for the round head) and 9W (for the square head) LED sources, located at both ends of a rocker arm. The electricity is conveyed via both profiles of the central stem through the rocker arm, feeding the two heads which are both in constant dynamic balance and in a continuous rise and fall movement.

Matériaux

Aluminium ; contrepoids de la base en zamac.

Specificità

Lampe de table avec deux sources LED distinctes et opposées de 3W (tête ronde) et 9W (tête carrée) situées aux extrémités d'un bras balancier. Le courant se transmet par le biais de deux profilés de la tige centrale au bras en balancier qui alimentent ainsi les deux têtes qui se positionnent en équilibre dans l'espace.

Materialien

Aluminium; Sockel-Gegengewicht aus Zamak.

Specification

Tischleuchte mit zwei unterschiedlichen LED-Quellen von 3W (runder Leuchtenkopf) und 9W (quadratischer Kopf) an den gegenüberliegenden Enden eines Schwingarms. Der Strom wird den Köpfen, die durch ein ständiges Auf und Ab in dynamischem Gleichgewicht bleiben, durch die Profile des zentralen Stabs und über den Schwingarm zugeführt.

Materialies

Aluminio; contrapeso de la base en zamak.

Specification

Lámpara de sobremesa con dos fuentes distintas y opuestas LED de 3W (del cabezal redondo) y 9W (del cabezal cuadrado), colocadas en los extremos de un brazo balancín. La corriente se transmite, a través de los dos perfiles del tallo central, al brazo balancín, alimentando los dos cabezales, que permanecen en un continuo arriba y abajo en un equilibrio dinámico y constante.





LED



Light emission



Colour



Black

Awards

2015 - Wallpaper Design Awards
"Best Office Accessories"

Materiali

Base in pressofusione di zama verniciata, corpo lampada in estruso di alluminio verniciato, stelo in acciaio cromato lucido.

Materials

Painted die-cast zamak base, painted aluminium extruded body, shiny chromed steel stem.

Matériaux

Base en zamak verni moulé sous pression, corps de la lampe en aluminium extrudé et verni, tige en acier chromé brillant.

Materialien

Leuchtenbasis aus lackiertem, fließgegossenem Zamak, Leuchtenkörper aus extrudiertem Aluminium, glänzendem Stahl.

Materiales

Base de zamak fundido a presión pintado, cuerpo lámpara de aluminio extruido, pie de acero cromado brillante.

Awards

2005 – “Observateur du Design”
Etoile 2005 A.P.C.I. – Paris (France)
Design Innovationen Design Zentrum
Nordrhein Westfalen
Reddot Design Award – Product Design
“Best of the Best 2006”
Essen (Deutschland)
Compasso D’oro / A.D.I.
Segnalazione 2008 – Milano (Italia)

Light emission



Colour







La possibilità di movimento del corpo luminoso attorno all'asse dello stelo e in verticale permettono di illuminare lo spazio di lavoro con flessibilità senza invaderlo. L'aggiornamento tecnologico delle sorgenti LED massimizza le performance di luce e l'efficienza di Talak.

Specificità

Con base tavolo o morsetto. Il corpo lampada ruota di 360° sul piano orizzontale ed è regolabile in altezza.

The possibility to move the lighting body around the stem and vertically provides flexible, non-intrusive illumination on the worktop. The technologically updated LED sources ensure maximum lighting performance and efficiency.

Specification

With table base or clamp. The body lamp rotates 360° on the horizontal plane and its height can be adjusted.

La possibilité de mouvement du corps lumineux autour de l'axe de la tige et verticalement permet d'éclairer l'espace de travail de manière flexible sans l'envahir. La mise à jour technologique des sources LED augmente au maximum les performances de lumière et l'efficacité de Talak.

Spécificité

Avec base ronde ou étau. Le corps de la lampe s'oriente jusqu'à 360° sur le plan horizontal et se règle en hauteur.

Die Bewegungsmöglichkeit vom Leuchtenkörper um die Achse des Leuchtenstabs und vertikal ermöglichen, den Arbeitsbereich flexibel zu beleuchten, ohne ihn zu überströmen. Die technologische Überarbeitung der LED-Lichtquellen maximiert die Leistung und Effizienz von Talak.

Spezifikation

Mit Fuß oder Klemmbefestigung. Der Leuchtenkörper kann horizontal um 360° gedreht werden und ist höhenverstellbar.

La posibilidad de movimiento del cuerpo luminoso alrededor del eje del pie y en vertical permiten iluminar el espacio de trabajo con flexibilidad sin invadirlo. La actualización tecnológica de las fuentes LED maximiza los rendimientos de luz y la eficiencia de Talak.

Especificaciones

Con base de sobremesa o mordaza. El cuerpo de la lámpara gira a 360° en sentido horizontal y es regulable en altura.

Lampada da tavolo a bracci mobili e testa orientabile.

Materiali

Base in acciaio verniciato; testa in alluminio verniciato; bracci in alluminio anodizzato.

Table lamp with adjustable arms and head.

Materials

Painted steel base; painted aluminium head; arms in anodized aluminium.

Lampe de table à bras mobiles et tête orientable.

Matériaux

Base en acier peint ; tête en aluminium peint ; bras en aluminium anodisé.

Tischleuchte mit verstellbarem Arm und verstellbarem Leuchtenkopf.

Materialien

Tischfuß aus lackiertem Stahl; Kopf aus lackiertem Aluminium; Arme aus eloxiertem Aluminium.

Lámpara de sobremesa con brazos móviles y cabeza orientable.

Materiales

Base de acero pintado; cabeza de aluminio pintado; brazos de aluminio anodizado.

Awards

2014 - Design plus

2015 - IF Product Design Award

Light emission**Colours**

Multicolor



LED







LED



Genera una completa libertà di gestione della luce grazie ai tre snodi che permettono un movimento praticamente a 360° in tutte le direzioni. Tutto è ridotto al minimo nella coincidenza tra struttura e circuiti, ne risulta un profilo estremamente leggero di soli 3 mm di spessore.

Generates full light management freedom through three joints that virtually allow a 360° movement in all directions. Everything is minimized at the connection between the frame and the circuits. The result is an ultra-light profile, barely 3 mm thick.

Elle crée une liberté totale de gestion de la lumière grâce aux trois articulations qui permettent un mouvement pratiquement à 360° dans toutes les directions. Tout est réduit au minimum dans la coïncidence entre la structure et les circuits ; il en résulte un profil extrêmement léger de 3 mm d'épaisseur seulement.

Sie schafft eine völlige Steuerungsfreiheit vom Licht aufgrund der drei Gelenke, die eine Bewegung von nahezu 360° in alle Richtungen ermöglichen. Alles ist in Struktur und Stromkreis übereinstimmend auf ein Minimum reduziert. Es handelt sich um ein äußerst leichtes Profil von nur 3 mm Dicke.

Genera una completa libertad de gestión de la luz gracias a las tres articulaciones que permiten un movimiento de casi 360° en todas las direcciones. Todo se reduce al mínimo en la coincidencia entre estructura y circuitos, obteniendo un perfil extremadamente ligero de solo 3 mm de espesor.



Light emission



Colours



White



Black





Materiali
Circuito stampato su alluminio.

Materials
Printed circuit on aluminum.

Matériaux
Circuit imprimé sur l'aluminium.

Materialien
Gedruckte Schaltung auf Aluminium.

Materialies
Circuito impreso sobre el aluminio.



Objective

Jean Nouvel
2013

Una lampada da tavolo composta da un volume elementare che si scompone in tre parti per attivare livelli percettivi di comprensione dello spazio, attraverso due sorgenti di luce a LED.

A table lamp distinguished by a simple shape breaking it down into three perfect geometrical volumes to awaken spatial perception on three levels by means of two LED light sources.

Une lampe de table aux formes élémentaires qui se compose en trois parties permettant d'activer des niveaux perceptifs de compréhension de l'espace à travers deux sources de LED.

Ein Zylinder wird in drei Segmente unterteilt, die jeweils eigene Bewegungsmöglichkeiten und Funktionen haben: ein Sockel, ein Glassegment, ein erster Leuchtenkopf sowie ein weiterer Leuchtenkopf.

Una lámpara de sobremesa compuesta por un volumen elemental que se descompone en tres partes para despertar la percepción espacial, a través de dos fuentes de luz a LED.



Awards

2014 - Design Plus Light+Building Award
Frankfurt (Deutschland)

2015 - IF Product Design Award

Light emission



Colour



Black



LED





Photo by Elliott Erwitt, 2013

Materiali

Corpo lampada in alluminio verniciato; diffusore in materiale metacrilato semi-opaco.

Specificità

La connotazione dell'oggetto - un tubo con l'alloggiamento di diverse ottiche - richiama la manipolazione di un obiettivo fotografico o cinematografico con i diversi segmenti che ospitano due diverse sorgenti luminose:

1) luce d'ambiente proveniente dal segmento metacrilato semi-opalino; 2) luce puntuale, dalla prima testa, sul piano di lettura o di lavoro; 3) luce puntata verso l'alto dal proiettore della seconda testa.

Materials

Lamp body in painted aluminium; diffuser in thermoplastic material.

Specification

The shape of the object – a cylinder containing different sets of optics – recalls the lens of a still or movie camera and its use, with two different segments housing two different light sources: 1) ambient light produced by the glass segment, 2) a spot light focused, from the first head, onto the work or reading plane, 3) upward light emitted by the floodlight in the second head.

Matériaux

Corps en aluminium verni, diffuseur en méthacrylate semi-opaque.

Spécificités

La connotation de l'objet -un tube avec le logement de différentes optiques- rappelle la manipulation d'un objectif photographique ou cinématographique avec les segments distincts qui hébergent deux effets lumineux : Lumière d'ambiance en provenance du segment en méthacrylate semi-opalin. Lumière ponctuelle sur le plan de lecture ou de travail. Lumière orientée vers le haut à partir du projecteur de la deuxième tête.

Materialien

Leuchtenkörper aus lackiertem Aluminium; Diffusor aus Metacrylat.

Spezifikation

Diese Tischleuchte - eine Röhre mit verschiedenen optischen Elementen - erinnert in ihrer Art und Handhabung an das Objektiv einer Foto- oder Filmkamera; die Einzelemente beherbergen jedoch zwei Lichtquellen für unterschiedliche Lichtverteilungen: 1) aus dem Glassegment abgestrahltes Umgebungslicht, 2) punktuell Licht zur Beleuchtung der Arbeitsfläche aus dem ersten Leuchtenkopf 3) indirektes Licht aus dem zweiten Leuchtenkopf.

Materiales

Cuerpo lámpara en aluminio pintado: difusor en material metacrilato semi-opaco.

Especificaciones

El carácter del objeto - con un tubo que contiene diferentes conjuntos de óptica - recuerda la manipulación de la lente de una cámara fija o película, con los tres segmentos diferentes que albergan dos fuentes de luz diferentes:

1) Luz de ambiente que proviene del segmento metacrilato semi-opalino; 2) Luz puntual, del primer cabezal, sobre el plano de lectura o de trabajo; 3) Luz hacia arriba desde el proyector del segundo cabezal.

Lampada da tavolo che bilancia comfort visivo ed esigenze di illuminazione dell'ambiente.

Materiali

La base cilindrica è in alluminio estruso, lo stelo orientabile è in ottone cromato e il diffusore in metacrilato.

Table lamp combining the needs for visual comfort and ambient lighting.

Materials

Cylindrical base in extruded aluminum, adjustable stem in chrome-plated brass, diffuser in methacrylate.

Lampe de table qui équilibre le confort visuel et les exigences d'éclairage de l'espace.

Matériaux

Base cylindrique en aluminium extrudé, tige orientable en laiton chromé et diffuseur en méthacrylate.

Eine neue Tischleuchte, die als Arbeitsplatz- und Ambiente-Beleuchtung gleichermaßen funktioniert.

Materialien

Runder Leuchtenkopf aus extrudiertem Aluminium; ausrichtbarer Stab aus verchromtem Messing; zylindrischer Sockel aus Aluminium und Zamak.

Lámparas de sobremesa que equilibra verdaderamente las necesidades de trabajo y de iluminación de ambiente.

Materials

La base cilíndrica está hechas de aluminio extruido, la tija orientable es de latón cromado ajustable y el difusor de metacrilato.

Awards

2015 - IF Product Design Award

2016 – Compasso d'Oro / A.D.I.

Milano (Italia); Honorable Mention

Light emission**Colour**

White



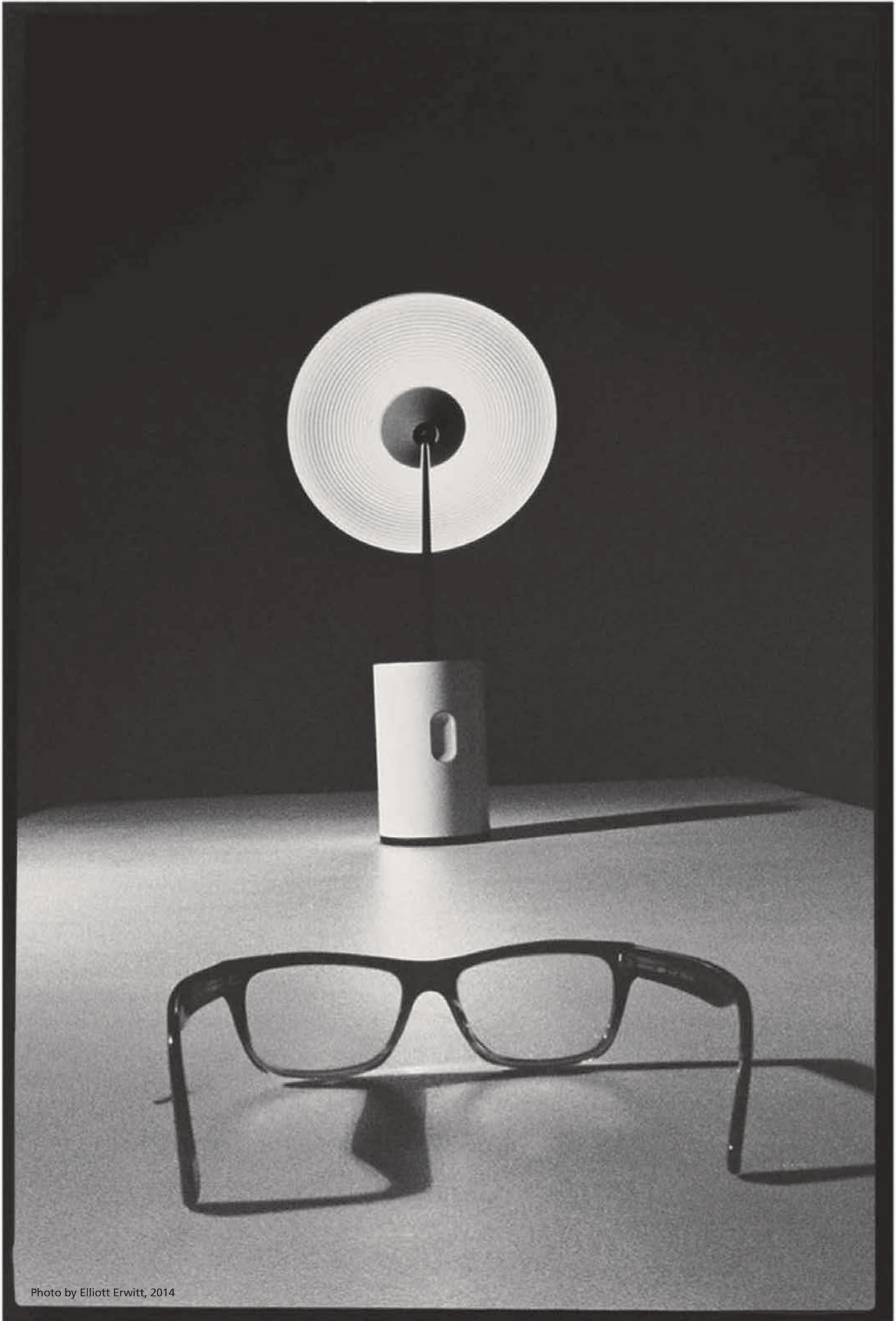
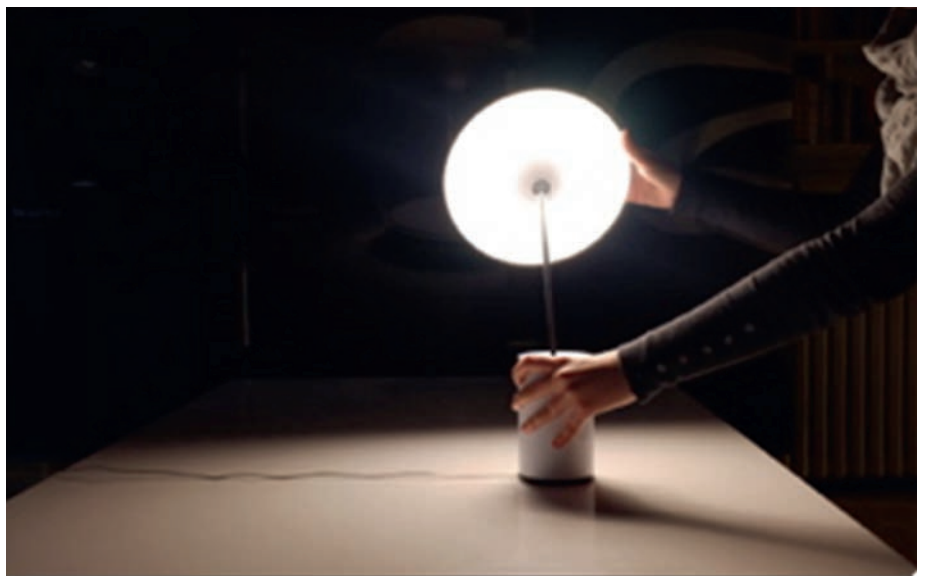

Photo by Elliott Erwit, 2014



Materiali

Base e stelo in acciaio verniciato, diffusore in metacrilato con supporto in alluminio.

Specificità

Lo snodo-calamita permette di posizionare l'anello luminoso su qualsiasi punto della struttura e di orientarlo di 360° sia sull'asse verticale che su quello orizzontale, conferendo la massima flessibilità nel direzionare la luce.

Materials

Painted steel base and stem, methacrylate diffuser with aluminium support.

Specification

The magnet articulation enables you to position the light ring on any point of the structure and to adjust it over 360° both on the vertical and the horizontal axis, allowing the maximum flexibility in directing the light.

Matériaux

Base et tige en acier peint, diffuseur en méthacrylate et support en aluminium.

Spécificité

L'articulation aimantée permet de déplacer l'anneau lumineux sur n'importe quel point de la structure et de l'orienter à 360° sur l'axe vertical comme sur l'axe horizontal ; ceci donnant la possibilité de diriger la lumière avec la plus grande flexibilité.

Materialien

Sockel und Stab aus lackiertem Stahl, Diffusor aus Methacrylat mit Aluminiumhalterung.

Spezifikation

Über ein Magnet-Gelenk kann der Leuchtenkopf an jeder beliebigen Stelle des Stabs befestigt werden. Und ist darüber hinaus um 360° sowohl auf der senkrechten als auch auf der waagrechten Achse schwenkbar. Hierdurch wird eine maximale Flexibilität garantiert.

Materiales

Pie y vástago, de acero pintado; difusor de metacrilato con soporte de aluminio.

Especificaciones

Gracias a la articulación-imán, es posible ubicar el anillo luminoso en cualquier punto de la estructura y orientarlo a 360°, ya sea en torno al eje vertical u horizontal. Así, se obtiene una flexibilidad máxima a la hora de orientar la luz.

Awards

2014 - Design plus

2015 - IF Product Design Award

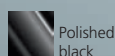
Light emission**Colour**

Polished
black



LED





Photo by Elliott Erwitt, 2013







LED

Materiali

Base in zama pressofusa; stelo in acciaio e diffusore in policarbonato rivestito da gomma silconica.

Specificità

L'impiego di uno snodo centrale permette di impugnare direttamente il diffusore e orientarlo sul piano verticale tra 0 e 90°. Il flusso dei Led è costante e uniforme lungo tutto l'anello luminoso.

Materials

Die-cast zinc-alloy base, steel stem, silicon rubber coated polycarbonate diffuser.

Specification

Thanks to the central pivot you can handle the diffuser directly to lean it vertically from 0 to 90 degrees. The flux of the LED is constant and uniform along the whole lighting ring.

Matériaux

Base en zama moulé sous pression, tige en acier et diffuseur en polycarbonate revêtu de caoutchouc siliconé.

Spécificité

L'emploi d'une rotule centrale permet de empoigner le diffuseur directement et l'orienter sur le plan vertical entre 0 et 90°. Le flux des Led est constant et uniforme dans tout l'anneau lumineux.

Materialien

Die Leuchtenbasis ist aus Druckguss einer Zamak-Legierung, der Stab aus Stahl und der Diffusor aus Polycarbonat beschichtet mit Silikongummi.

Spezifikation

Der zentrierte Stab ermöglicht die variable vertikale Positionierung des Leuchtenkopfs von 0° bis 90°. Der Lichtstrom der Led entlang des gesamten Rings ist konstant und gleichmäßig.

Materiales

Base de zamak fundida a presión, pie de acero y difusor de policarbonato revestido de goma de silicona.

Especificaciones

El uso de un nudo central le permite mantener directamente el difusor y orientarlo hacia el plano vertical entre 0 y 90°. El flujo de los LED es constante y uniforme a lo largo de todo el anillo luminoso.

Awards

2012 - IF Product Design Award
Hannover (Deutschland)

Light emission



Colour



White





Eclittica 20 table

Carlotta de Bevilacqua
2013

Attraverso il minimo della presenza fisica determina un effetto sorprendente grazie ai giochi di luce ed ombra che crea.

Materiali

Alluminio verniciato e policarbonato.

Specificità

Il diffusore ruota a 358°.

With a minimal physical presence, it produces a surprising effect through the light and shadow contrasts it creates.

Materials

Painted aluminum and polycarbonate.

Specification

The diffuser spins 358°.

Par le minimum de sa présence physique, elle produit un effet surprenant grâce aux jeux de lumières et d'ombres qu'elle crée.

Matériaux

Aluminium peint et polycarbonate.

Spécificité

Le diffuseur pivote à 358°.

Durch das Minimum an physischer Präsenz löst sie aufgrund der Spiele mit Licht und erzeugenden Schatten eine erstaunliche Wirkung aus.

Materialien

Lackiertem Aluminium und Polycarbonat.

Spezifikation

Der Kreis dreht sich zu 358°.

A través de una presencia física mínima, determina un efecto sorprendente gracias a los juegos de luces y sombras que crea.

Materiales

Aluminio pintado y policarbonato.

Especificaciones

El círculo gira en 358°.



Light emission



Colour



Un archetipo paralume in equilibrio su uno stelo inclinato crea una bilanciata composizione geometrica che stupisce pur nella sua semplicità. Le forme elementari sono combinate a materiali diversi per ragioni tecnologiche.

Materiali

Struttura in alluminio, diffusore in policarbonato.

Specificità

Il paralume è un leggero volume plastico chiuso da due diffusori che producono una piacevole morbida luce diretta e indiretta.

An archetypal lampshade fitted on a tilted stem creates a surprising well-balanced, yet very simple geometric composition. Its basic forms are combined with a variety of materials for technological reasons.

Materials

Aluminium frame, polycarbonate diffuser.

Specification

The lampshade is a lightweight plastic body closed by two diffusers that produce a pleasant soft direct and indirect light.

Un archétype d'abat-jour en équilibre sur une tige inclinée crée une position géométrique équilibrée qui surprend par sa simplicité. Ses formes élémentaires sont associées à des matières différentes pour des raisons technologiques.

Matériaux

Structure en aluminium, diffuseur en polycarbonate.

Spécificité

L'abat-jour est un léger volume plastique fermé par deux diffuseurs qui produisent une lumière douce et agréable, directe et indirecte.

Ein Archetyp des Lampenschirms auf einem geneigten Stab erzeugt eine ausgewogene geometrische Komposition, die trotz ihrer Einfachheit überrascht. Die Grundformen werden aus technischen Gründen mit verschiedenen Materialien kombiniert.

Materialien

Aluminiumstruktur, Diffusor aus Polycarbonat.

Spezifikation

Der Lampenschirm besteht aus einem leichten Kunststoff-Volumen, geschlossen von zwei Diffusoren, die ein angenehm weiches direktes und indirektes Licht erzeugen.

Una pantalla arquetipo en equilibrio en un pie inclinado crea una composición geométrica equilibrada que sorprende a pesar de su sencillez. Las formas elementales están combinadas con materiales diferentes por razones tecnológicas.

Materiales

Estructura de aluminio, difusor de polycarbonato.

Especificaciones

La pantalla es un ligero volumen plástico cerrado por dos difusores que producen una agradable y suave luz directa e indirecta.

Light emission



Colours



Black



White





Light emission



Colour



Anodized
black



Anodized
grey



LED

Fiamma è un elemento di luce sistemico, pensato per rispondere a tutte le esigenze del contract, ma che ben si adatta anche a tutti gli ambienti del living quotidiano.

Materiali

Corpo della lampada in alluminio estruso modellato meccanicamente per ottenere l'effetto tridimensionale che evoca le forme di una fiamma; stelo in alluminio; base in acciaio verniciato; diffusore in policarbonato trasparente stampato ad iniezione.

Specificità

Il cilindro in alluminio estruso è il vero e proprio motore luminoso del sistema. La luce emessa dalla sorgente a LED è sapientemente controllata da un diffusore trasparente, pensato con una texture antiriflesso per creare confort visivo in tutte le situazioni di utilizzo.

Fiamma is a systemic lighting element designed to fulfill the requirements of the contract industry, while at the same time being suitable for every living environment.

Materials

Lamp body in extruded aluminum, mechanically moulded to achieve a textured effect evoking the shape of a flame; aluminium stem; painted steel base; transparent injection-moulded polycarbonate diffuser.

Specification

The cylinder in anodized aluminium is the lighting core of the product. The light emitted by the LED source is cleverly controlled by a transparent diffuser, designed with an anti-reflective coating to ensure visual comfort in all usage situations.

Fiamma est un élément de lumière systémique, imaginé pour répondre à toutes les exigences du marché « contract » mais qui s'adapte aussi à tous les espaces à vivre.

Matériaux

Corps en aluminium extrudé usiné pour obtenir l'effet texturé qui rappelle les formes d'une flamme ; tige en aluminium; base en acier verni diffuseur en polycarbonate transparent moulé.

Spécificités

Le cylindre en aluminium extrudé représente le véritable moteur lumineux du système. La lumière émise par la source LED est judicieusement contrôlée par un diffuseur transparent imaginé avec une texture anti reflet afin de créer un confort visuel dans tous les contextes d'utilisation.

Fiamma ist ein systemisches Lichtelement, das sich in ein professionelles Ambiente ebenso gut einfügt wie in jedes private Wohnumfeld.

Materialien

Der Leuchtenkörper, dessen mechanisch erzeugte Struktur an eine Flamme erinnert, besteht aus fließgepresstem Aluminium. Struktur aus Aluminium; Sockel aus lackiertem Stahl. Der transparente Schirm aus Polycarbonat ist spritzgegossen.

Spezifikation

Der Zylinder aus fließgepresstem Aluminium bildet das Herzstück des Lichtsystems. Der transparente Schirm mit Antireflex-Struktur lenkt das von der LED Quelle erzeugte Licht dorthin, wo es benötigt wird und gewährleistet ausgezeichneten Sehkomfort.

Fiamma es un elemento e iluminación sistémica diseñado para responder a todas las exigencias del contract, pero que también se adapta a todos los ambientes del living cotidiano.

Materiales

Cuerpo de la lámpara en aluminio extruido modelado mecánicamente para obtener el efecto de textura que reclama las formas de una llama; tija en aluminio pintado; base de acero pintado; difusor en policarbonato transparente moldeado por inyección.

Especificaciones

El cilindro de aluminio anodizado es el verdadero motor del sistema luminoso. La luz que emite la fuente de led está controlada por un difusor transparente, diseñado con una textura anti-reflejo, para asegurar el confort visual en todas las condiciones de uso.

Melampo Melampo notte

Adrien Gardère
2000

Materiali

base in zama verniciata; stelo in alluminio verniciato;
diffusore in raso di seta, supportato da tecnopolimero.

Specificità

diffusore orientabile in tre diverse posizioni nella versione
tavolo e in due diverse posizioni nella versione notte.

Materials

Base in painted zamak; painted aluminium stem;
diffuser in silk satin fabric on a technopolymer frame.

Specification

Adjustable diffuser into three different positions by the table
version and into two positions by the night-table version.

Matériaux

Base en zamak peint ; tige en aluminium peint ;
diffuseur en techno-polymère recouvert de satin de soie.

Spécificité

Diffuseur orientable dans trois positions différentes pour
la version de table et dans deux positions différentes
pour la version de chevet.

Materialien

Sockel aus lackiertem Zamak; Stab aus lackiertem Aluminium;
Schirm aus Seidensatin (stabilisiert mit Technopolymer).

Spezifikation

Der Schirm ist bei der Tischleuchte in drei und bei der
Nachtischleuchte in zwei Positionen verstellbar.

Materiales

Pie de zamak pintado; tija de aluminio pintado; difusor
en raso seda reforzado con tecnopolímero.

Especificaciones

Difusor orientable en tres posiciones diferentes en la versión
de sobremesa y en dos posiciones en el modelo noche.

Awards

2001 – "Observateur du Design"
Etoile 2001 A.P.C.I. – Paris (France)
2001 – Reddot Design Award
Essen (Deutschland)

Light emission



Colours



Base and stem:
Silver grey



Base and stem:
Bronze



Diffuser:
Grey



Diffuser:
Natural



Silver grey finishing



Bronze finishing



Silver grey finishing

Choose

Matteo Thun
2006

Materiali

Base in zama; struttura in acciaio cromato; diffusore orientabile in policarbonato accoppiato a un foglio di carta pergamena.

Specificità

Il diffusore si inclina di 30° e ruota di sul proprio asse di 350°.

Materials

Base in zamac, chrome-plated steel structure, adjustable diffuser in transparent polycarbonate, joined with parchment paper.

Specification

The diffuser tilts 30° and rotates 350° on its axis.

Matériaux

Base en zamac ; structure en en acier chromé ; diffuseur orientable en polycarbonate couplé à une feuille de papier parchemin.

Spécificité

Le diffuseur s'incline de 30° et peut pivoter sur son axe à 350°.

Materialien

Leuchtenfuß aus Zamak; Struktur aus verchromtem Stahl; verstellbarer Schirm aus Polycarbonat mit Pergamentpapier.

Spezifikation

Schirm: schwenkbar um 30°, drehbar um 355°.

Materiales

Pie de zamak; estructura de acero cromado; difusor orientable de policarbonato junto con tela de pergamino.

Especificaciones

El difusor se inclina a 30° y gira sobre si mismo hasta 350°.



Light emission



Colours



Base and stem:
Mirror



Base and stem:
Mirror



Diffuser:
Natural



Diffuser:
White



194 372 440

LED



Laguna 16, 26, 36

Matteo Thun
Antonio Rodriguez
2013

Materiali

Corpo della lampada in alluminio estruso dorato; diffusore in vetro soffiato.

Specificità

Il vetro soffiato lattimo con sfumatura cristallo permette di ottenere una luce morbida localizzata sul piano o sulla parete e una luce più performante verso l'ambiente.

Materials

Lamp body in golden extruded aluminum; diffuser in blown glass.

Specification

The milkywhite, blown glass with crystal nuances produces a soft spot light on the table top or wall, plus a highperforming light towards the surrounding environment.

Matériaux

Corps en aluminium extrudé doré, diffuseur en verre soufflé.

Spécificité

Le verre soufflé laiteux avec une nuance cristal permet d'obtenir une lumière douce et localisée sur le plan ou sur le mur ainsi qu'une lumière plus performante vers l'espace.

Materialien

Der Leuchtenkörper, besteht aus fließgepresstem Aluminium gold; Schirm aus mundgeblasenem Glas.

Spezifikation

Das mundgeblasene Opalglas mit kristallinen Nuancen gibt einen weichen Spot nach oben ab und streut gleichzeitig leistungsstarkes Licht in die Umgebung.

Materiales

Cuerpo de la lámpara en aluminio extruido dorado; difusor en cristal soplado.

Especificaciones

El cristal soplado de color blanco lechoso permite obtener una luz mórbida localizada sobre el suelo o en la pared y una luz de alto rendimiento en todo el entorno.



Light emission



Colours



Base:
Gold



Diffuser:
Transparent with silk finishing



Empatia 16, 26, 36

Carlotta de Bevilacqua
Paola di Arianello
2013



Light emission



Colours



Base:
White



Diffuser:
Transparent with silk finishing

Empatia 26

Empatia 16



Empatia 36

La famiglia di lampade Empatia composta dalle versioni tavolo, parete/soffitto, sospensione e terra, nasce dal connubio tra la grande tradizione del vetro soffiato veneziano e la LED technology.

The Empatia family is available in table, wall / ceiling, suspension and floor versions, born from the synthesis between a great ancient glass-blowing tradition and state-of-the-art LED technologies.

La famille de lampes Empatia composée des versions lampe de table, applique/plafonnier, suspension et lampadaire nait de la rencontre entre la tradition du verre soufflé vénitien et la technologie LED.

Die Leuchtenfamilie Empatia besteht aus Tisch-, Wand-/Decken-, Pendel-, sowie Bodenleuchten und vereint die große venezianische Tradition der Glasbläserei mit neuester LED-Technologie.

La familia de lámparas Empatia formada por las versiones de sobremesa, pared/techo, suspensión y pie, nace de la asociación entre la gran tradición del soplado del cristal y la tecnología LED.

Awards

2014 - Wallpaper Design Awards
"Best Transparency"

2014 - iF Product Design Award







Photo by Elliott Erwit, 2013

Materiali

Dissipatore/nucleo elettronico in alluminio verniciato; diffusore in vetro soffiato trasparente con finitura seta lucida; guida luce in metacrilato a basso coefficiente di assorbimento; piastra di fissaggio del vetro in alluminio verniciato.

Specificità

La lavorazione artigianale permette di ottenere dei pezzi unici, dove la trasparenza e l'opacità sono sapientemente dosati per ottenere un vetro che riflette e diffonde la luce senza abbagliare e perdere in efficienza. La macchina ottica ha il suo cuore in un light engine LED dalle elevate prestazioni. La luce è controllata con il massimo rendimento e guidata al diffusore in vetro attraverso un light pipe trasparente dal bassissimo coefficiente di assorbimento.

Materials

Heatsink/electronic unit in painted aluminium; diffuser in blown glass with polished-silk finish; light pipe made by low absorption coefficient methacrylate; glass back plate in painted aluminium.

Specifications

The art of craftsmanship creates unique glass pieces, where light is reflected without glaring and loss of efficiency through a well-measured combination of transparency and opaqueness. The optical device includes a high-performance LED-based light engine, which is separated from the glass emission body for higher thermal efficiency and performance.

Matériaux

Dissipateur thermique/unité électronique en aluminium verni ; diffuseur en verre soufflé transparent avec finition en soie brillante ; guide lumière en méthacrylate ayant un coefficient d'absorption réduit ; plaque de fixation du verre en aluminium verni.

Spécificités

Le travail artisanal permet d'obtenir des pièces uniques où la transparence et l'opacité sont judicieusement dosées afin d'obtenir un verre qui réfléchit et diffuse la lumière sans éblouissement et sans perte d'efficacité lumineuse. Le dispositif optique a en son cœur un moteur d'éclairage LED haute performance positionné séparément du corps en verre pour une grande efficacité. La lumière est contrôlée avec un rendement maximal et dirigée jusqu'au diffuseur en verre par le biais d'un guide lumière transparent ayant un coefficient d'absorption très bas.

Materialien

Kühlkörper/elektronische Beleuchtungseinheit aus lackiertem Aluminium; Schirm aus transparentem, mundgeblasenem Glas in seidig glänzendem Finish; Lichtstab aus Metacrylat mit niedrigem Absorptionskoeffizienten; Befestigungsplatte für das Glas aus lackiertem Aluminium.

Spezifikation

Die Glasbläserei erzeugt Unikate, in denen Transparenz und Opazität sorgfältig dosiert werden, um ein Glas herzustellen, das Licht ohne Blendwirkung und Strahlungsverlust reflektiert. Das Herzstück bildet eine leistungsstarke LED Beleuchtungseinheit, die zugunsten des Wärmewirkungsgrads und der Leistung vom gläsernen Emissionskörper getrennt ist. Das Licht wird mit maximaler Ausbeute durch einen transparenten Lichtstab mit äußerst geringem Absorptionskoeffizienten zum Glasschirm gelenkt.

Materiales

Disipador/núcleo electrónico en aluminio pintado; difusor en cristal soplado transparente con acabado seda lúcido; guía de luz en metacrilato de bajo coeficiente de absorción; plancha de fijación del cristal en aluminio pintado.

Especificaciones

La elaboración artesanal permite obtener piezas únicas; donde la transparencia y la opacidad son sabiamente dosificadas para obtener un vidrio que refleja la luz sin deslumbrar y sin perder eficiencia. La unidad óptica tiene como núcleo un motor de luz LED de alto rendimiento. La luz controlada con el máximo rendimiento y conducida hacia el difusor de cristal a través de un tubo transparente con un coeficiente de absorción muy bajo.

Meteorite 15, 35, 48

Pio & Tito Toso
2014

Famiglia di lampade che si articola in cinque tipologie:
tavolo, tavolo con stelo, terra, parete/soffitto e sospensione.

A family of lamps available in five different versions: table,
table with stem, floor, wall/ceiling and suspension.

Il s'agit d'une famille de lampes qui s'articule en cinq typologies :
lampe à poser, lampe de table, lampadaire, applique/plafonnier
et suspension.

Die Leuchtenfamilie besteht aus Tischleuchten mit oder ohne
Stab, Boden-, Wand- / Decken-, und Pendelleuchten.

Una familia de lámparas compuesta por 5 tipologías: sobremesa,
sobremesa con tija, pie, pared/techo y suspensión.

Awards

2015 - Reddot Design Award:
High Design Quality
Essen (Deutschland)



Meteorite 15

Meteorite 35

Light emission



Colour



White

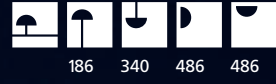

LED



Meteorite 48

Meteorite 15, 35 stem

Pio & Tito Toso
2015

Materiali

Diffusore in vetro soffiato; corpo della lampada in tecnopolimero e acciaio.

La versione Meteorite 15 Stem ha lo stelo in alluminio cromato, mentre la versione 35 ha lo stelo in acciaio.

Specificità

Il diffusore è realizzato in vetro artistico a doppio strato, ottenuto con la tecnica artigianale della soffiatura in stampo a fermo e la conseguente molatura.

Materials

Blown glass diffuser; lamp body in technopolymer and steel. Meteorite Stem Table 15 and 35 feature respectively a chromed aluminium and a steel stem.

Specification

The diffuser is made of a double layer of artistic glass, obtained through a 'stampo a fermo' mould-blowing technique and then grinding.

Matériaux

Diffuseur en verre soufflé ; corps en techno-polymère et acier. La version lampe de table Meteorite 15 prévoit une tige en aluminium chromé tandis que la version 35 prévoit une tige en acier.

Spécificités

Le diffuseur est réalisé en verre artistique avec une double couche, obtenu avec la technique artisanale du soufflage dans un moule fermé et traité avec un abrasif.

Materialien

Schirm aus mundgeblasenem Glas; Leuchtenkörper aus Technopolymer und Stahl. Die Tischleuchte Meteorite 15 besitzt einen verchromten Aluminiumstab während der Stab der Meteorite 35 aus Stahl gefertigt ist.

Spezifikation

Der Schirm besteht aus doppelschichtigem Kunstglas, hergestellt in einem speziell entwickelten handwerklichen Fertigungsprozess aus Mundbläserei und Schleiftechnik.

Materiales

Difusor en cristal soplado; cuerpo de la lámpara en tecnopolimero y acero. La versión Meteorite 15 stelo tavolo tiene la tija en aluminio cromado, mientras la versión 35 tiene la tija en acero.

Especificaciones

El difusor está hecho de una doble capa de vidrio artístico, que se obtiene con la técnica artesanal de soplado y moldeado.

Light emission



Colour



White



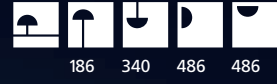

LED



Meteorite 35 stem



Meteorite 15 stem

Castore 14, 25, 35

Michele De Lucchi
Huub Ubbens
2003

Materiali

Base in zama; stelo in policarbonato; diffusore in vetro soffiato acidato.

Specificità

Un tasto d'accensione touch, presente sulla base di Castore 25 and 35 permette la regolazione dell'intensità luminosa, la memorizzazione dell'ultimo livello di luce impostato e la possibilità di scegliere tra comando locale e comando remoto (presa comandata).

Materials

Base in zamak, stem in polycarbonate, acid-etched blown glass diffuser.

Specification

Castore 25 and 35 have a touch dimmer button on the lamp base for the storage of the last light intensity set-up or the use of a local or remote control (controlled socket).

Matériaux

Base en zamak, tige en polycarbonate, diffuseur en verre soufflé traité à l'acide.

Spécificité

Castore 25 et 35 sont dotées d'un variateur sensible situé sur la base, pour la mémorisation du dernier niveau d'intensité lumineuse établi et la possibilité de choisir entre la commande déportée (interrupteur) ou directement sur le luminaire.

Awards

2004 – Design Plus, Light + Building
Frankfurt am Main (Deutschland)

2004 – Reddot Design Award
Essen (Deutschland)

2004 – Compasso d'oro / A.D.I.
Segnalazione – Milano (Italia)

Light emission



Colour



White

Materialien

Fuß aus Zamak, Stab aus Polycarbonat, Schirm aus mundgeblasenem, geätztem Glas.

Spezifikation

Ein Touch-Dimmer am Fuß der Tischleuchte Castore 25 und 35 ermöglicht die Regelung und die Speicherung der Lichtintensität und bietet außerdem die Möglichkeit, zwischen Hand- und Fernbedienung zu wählen (Steckdosenschalter).

Materiales

Base en zamak, tija en polycarbonato, difusor en cristal soplado al ácido.

Especificaciones

Una tecla que enciende por contacto y que se encuentra en la base de Castore 25 y 35 permite la regulación de la intensidad luminosa y la memorización del último nivel de intensidad configurado y la posibilidad de elegir entre mando exclusivamente local y mando a distancia (toma accionada).



Touch dimmer
for Castore 25, 35

Functions:
1) memo
2) reset



Castore 25

Castore 14

Castore 35

Dioscuri 14, 25, 35, 42

Michele De Lucchi
2000

Materiali

Base in policarbonato con zavorra in acciaio;
diffusore in vetro soffiato acidato.

Materials

Polycarbonate base with steel ballast;
acid-etched blown glass diffuser.

Matériaux

Base en polycarbonate avec lest en acier;
diffuseur en verre soufflé traité à l'acide.

Materialien

Leuchtenbasis aus Polycarbonat mit Stahlballast,
Kugel aus mundgeblasenem geätztem Glas.

Materiales

Base de policarbonato con estabilizador de acero,
difusor de vidrio soplado al ácido.



Light emission



Colour



White

Dioscuri 25



Dioscuri 42

Dioscuri 14

Dioscuri 35

Logico table Logico mini table

Michele De Lucchi
Gerhard Reichert
2001

Materiali

Base in zama cromata, struttura in acciaio cromato; diffusore in vetro soffiato con finitura seta lucida. Soffiatura a tre strati (cristallo + effetto seta + cristallo) in stampo a fermo con forma capovolta per garantire solidità strutturale del vetro.

Specificità

Un tasto d'accensione touch, presente su Logico tavolo e Logico mini tavolo, permette la regolazione dell'intensità luminosa.

Materials

Chromed zinc-alloy base, chrome-plated steel structure; blown glass diffuser with polished-silk finish. Three layers blown glass (crystal + silk + crystal) in a mold which is upside down to assure structural consistence to glass.

Specification

Logico tavolo and Logico tavolo mini have a touch dimmer to adjust the light intensity.

Matériaux

Base en zama chromé, structure en en acier chromé ; diffuseur en verre soufflé, finition soie brillante. Verre soufflé en trois couches (cristal + effet soyeux + cristal) dans un moule qui a une forme inversée pour garantir la solidité structurale du verre.

Spécificité

Logico tavolo et Logico tavolo mini sont dotées d'un variateur sensible, pour agir sur l'intensité lumineuse.

Materialien

Leuchtenbasis aus verchromter Zamak-Legierung, Struktur aus verchromtem Stahl; Schirm aus geblasenem Glas in seidig glänzendem Finish. Drei Glasschichten (Kristall + Seide + Kristall) in einer Form, die umgekehrt positioniert ist um die Stabilität des Glases zu gewährleisten.

Spezifikation

Die Versionen Logico tavolo und Logico tavolo mini sind mit einem Touch-Dimmer ausgestattet.

Materiales

Base de zamak cromada, estructura de acero cromado; difusor de cristal soplado con acabado de seda brillante. Soplado a tres capas (cristal + efecto seda + cristal) en un molde con forma invertida para asegurar la resistencia estructural del cristal.

Especificaciones

Una tecla que enciende por contacto y que se encuentra en Logico tavolo y Logico tavolo mini permite la regulación de la intensidad luminosa.

Awards

Logico table
Design Innovationen Design Zentrum
Nordrhein Westfalen
2004 – Reddot Design Award
Essen (Deutschland)



Grey diffuser



Tobacco diffuser

Light emission



Colours

- Base and Stem: Mirror
- Diffuser: White
- Diffuser: Tobacco
- Diffuser: Grey



356 444 526

LED



Logico mini

Logico

Materiali

Corpo e diffusore in vetro soffiato opalino;
bordo del diffusore in cristallo trasparente riportato a caldo.

Materials

Body and diffuser in opaline blown glass.
Transparent crystal edge added.

Matériaux

Corps et diffuseur en verre soufflé opalin ;
bord du diffuseur en cristal transparent appliqué à chaud.

Materialien

Leuchtenkörper aus mundgeblasenem Opalglas;
Rand aus transparentem Kristallglas.

Materiales

Cuerpo y difusor, de cristal soplado opalino; borde del difusor
de cristal transparente, aplicado en caliente.

Light emission



Colour



White



Dalù

Vico Magistretti
re-edition 2005

Materiali

Policarbonato stampato a iniezione.

Materials

Injection-moulded polycarbonate diffuser.

Matériaux

Diffuseur en polycarbonate moulé.

Materialien

Der Schirm aus Polycarbonat ist spritzgegossen.

Materiales

Difusor en policarbonato estampado a inyección.



Light emission



Colour



Polished black



Polished white



Gioca sulla destrutturazione del profilo di base, la luce proiettata attraverso gli anelli in equilibrio disegna sottili ombre nella definizione di una perfetta qualità di luce nello spazio.

Materiali

Alluminio anodizzato.

Featuring a deconstructed base profile, the light projected through the balanced rings designs subtle shadows while defining a perfect quality of light in space.

Materials

Anodized aluminum.

Elle joue sur la déstructuration du profil de base ; la lumière projetée à travers les anneaux en équilibre dessine de fines ombres pour la définition d'une qualité parfaite de la lumière dans l'espace.

Matériaux

Aluminium anodisé.

Sie spielt mit der Destrukturierung vom Basisprofil. Das durch die ausgeglichenen Ringe projizierte Licht zeichnet dünne Schatten in der Definition einer perfekten Lichtqualität in den Raum.

Materialien

Aluminium eloxiert.

Juega con la desestructuración del perfil de base, la luz proyectada a través de los anillos en equilibrio diseña sombras finas en la definición de una calidad perfecta de la luz en el espacio.

Materiales

Aluminio anodizado.

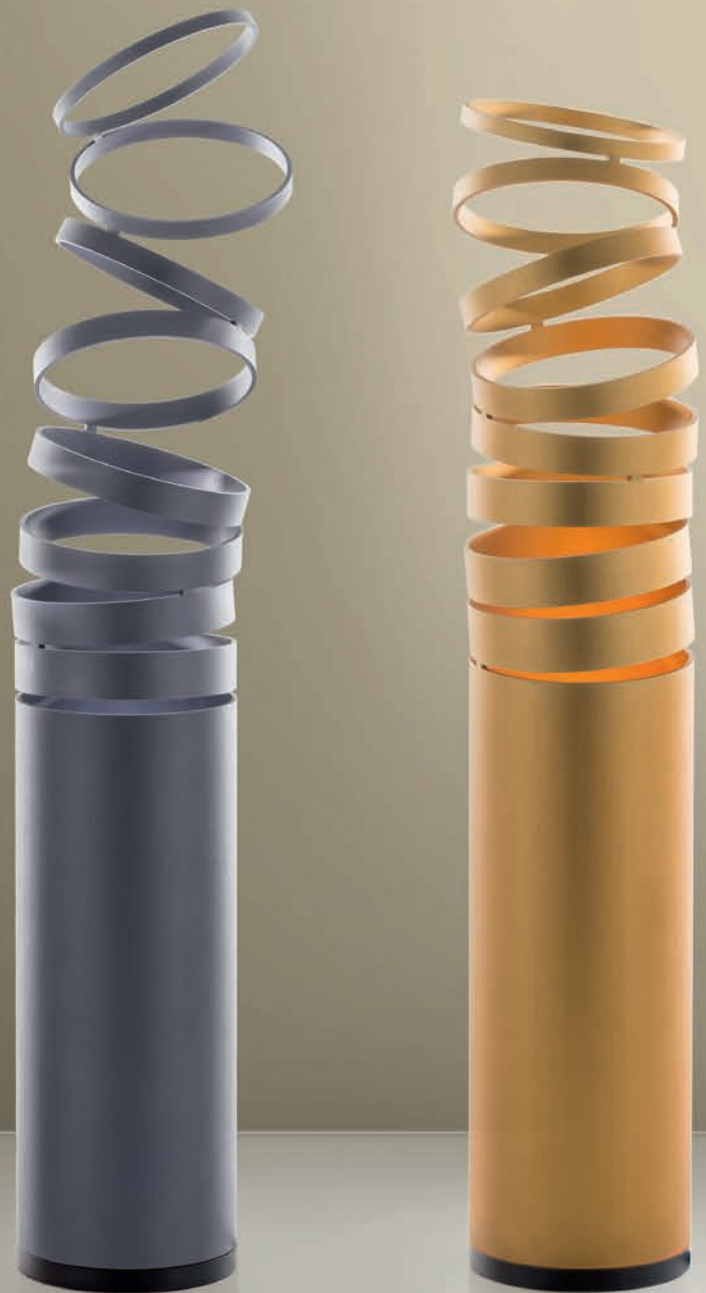

Light emission



Colours

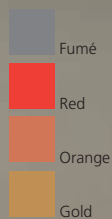

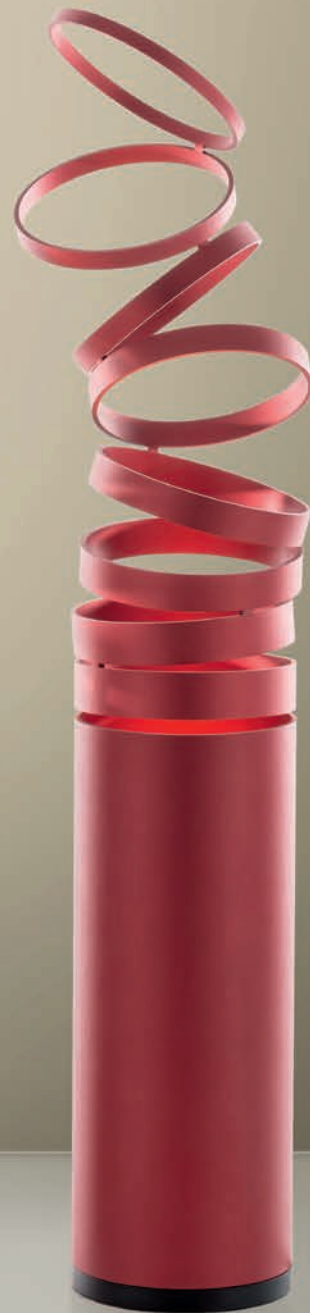

Lampade da terra

Floor lamps
Lampadaires
Stehleuchten
Lámparas de pie



138
Ilio



142
Athena



146
New Nature



150
Cadmo



170
Tizio floor
support



172
Talak professional
reading floor



174
Cabildo LED
floor



176
Cosmic Leaf



194
Choose floor
mega floor



196
Tolomeo floor
micro floor
reading floor



198
Tolomeo
basculante floor
reading floor



200
Tolomeo mega



152
Solium



154
Mimesi



156
Megaron LED



158
Décomposé light
floor



160
Reall



164
Fiamma reading
floor



166
Fiamma 15



168
Demetra reading
floor



178
Trix floor



180
Vigo reading
floor



182
Reeds



184
Empatia 26 floor



186
Meteorite 35 floor



188
Castore 35 floor



190
La Petite floor



192
Melampo floor
mega floor



202
Tolomeo paralume
outdoor



202
Tolomeo lampione
outdoor



208
Tolomeo XXL

Ilio

Ernesto Gismondi
2013

Estrema sintesi geometrica, spogliata di ogni digressione formale e portata all'essenziale, Ilio manifesta la sua presenza attraverso il colore saturo.

Materiali

Base in acciaio verniciato; corpo in alluminio estruso verniciato.

With simple geometry, back to basics and stripped of all decorative features, Ilio stands out through the use of saturated colours.

Materials

Base in painted steel; body lamp in extruded painted aluminum.

C'est une synthèse géométrique extrême, dépourvue de toute dégression formelle réduite à sa plus simple expression. Ilio manifeste toute sa présence à travers la couleur saturée.

Matériaux

Base en acier verni; corps en aluminium extrudé et verni.

Extrem geometrisch, befreit von jeder formellen Abschweifung und auf das Wesentliche reduziert, erzielt Ilio ihre Präsenz durch die satten Farben.

Materialien

Sockel aus lackiertem Stahl; Leuchtenkörper aus fließgepresstem Aluminium.

Con una geometría simple, despojado de todas digresiones formales y reducido a sus elementos básicos, Ilio llama la atención por su la saturación del color.

Materiales

Base en acero pintado; cuerpo lámpara en aluminio extruido y pintado.





LED



Light emission



Colours



White



Black polished



Electric blue



Amber orange



Yellow cedar



Rubin red





Photo by Elliott Erwitt, 2013

Lampada da terra con emissione diffusa indiretta, la cui essenzialità è la caratteristica principale del progetto.

Materiali

Base e stelo in acciaio, testa in pressofusione di alluminio.

Specificità

Due identici dischi sottili alla base e nel top sono collegati da un sottile stelo tubulare. La sua eleganza minimale lo rende un oggetto senza tempo.

Floor lamp with indirect diffused emission. Utmost simplicity is the main feature of the project.

Materials

Steel base and stem, die-cast aluminium head.

Specification

Two identical thin discs at the base and at the top are connected by a thin tubular stem. Minimal elegance gives life to a timeless object.

Lampe au sol à émission diffuse indirecte dont l'aspect essentiel est la caractéristique principale du projet.

Matériaux

Base et tige en acier, tête réalisée en aluminium moulé sous pression.

Spécificité

Deux disques fins identiques à la base et au sommet sont reliés par une tige tubulaire fine. Son élégance minimale en fait un objet intemporel.

Stehleuchte mit indirekter, diffuser Lichtemission, deren Einfachheit Hauptmerkmal des Projekts ist.

Materialien

Leuchtenbasis und -stab aus Stahl, Leuchtenkopf aus Aluminiumdruckguss.

Spezifikation

Zwei identische dünne Scheiben an der Leuchtenbasis und an der Oberseite sind durch einen dünnen, röhrenförmigen Stab verbunden. Ihre minimale Eleganz macht sie zu einem zeitlosen Objekt.

Lámpara de pie con emisión difusa indirecta, cuya esencialidad es la característica principal del proyecto.

Materiales

Base y pie de acero, cabeza realizada en aluminio moldeado bajo presión.

Especificaciones

Dos discos delgados idénticos en la base y en la parte superior están conectados por un pie tubular fino. Su elegancia minimal lo convierte en un objeto atemporal.

Light emission



Colour



Base, diffuser:
Black



LED

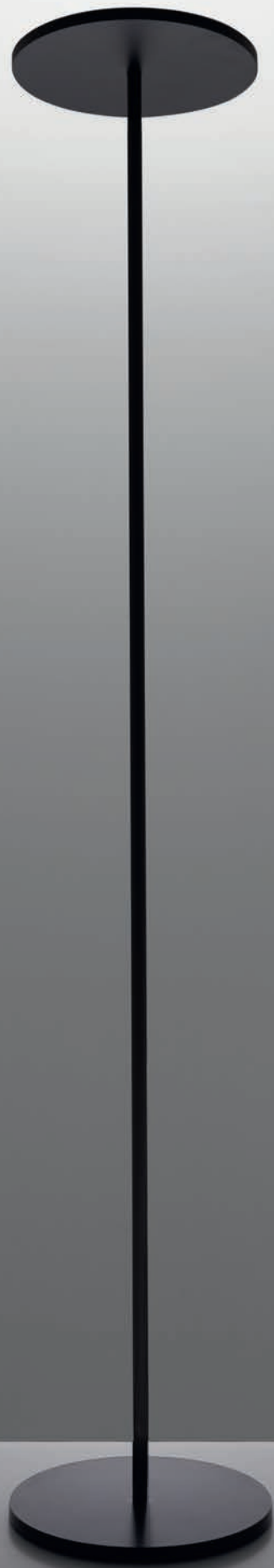





"Questo prodotto avanzato di alto valore gioca con geometrie fluide prese in prestito dalla botanica, creando un nuovo tipo di illuminazione nello spazio, gettando sui muri e sulle superfici fasci di luce sovrapposti e ombre, interpretando al meglio il concetto di tridimensionalità".

Materiali

Base in acciaio cromato; corpo illuminante in pressofusione di alluminio con finitura cromata, struttura in tecnopolimero stampato a iniezione.

Specificità

I LED dell'emissione indiretta principale sono posti nella parte superiore della lampada. I LED dell'emissione secondaria, d'ambiente, sono posti alla base e disegnano l'interno della colonna esaltandone la tridimensionalità. Le due accensioni sono gestibili separatamente.

"This highly developed product of great quality plays with fluid geometries inspired by botanic shapes to define a new kind of light diffusing in space, casting overlapping beams of light and shadow over walls and surfaces in a three dimensional way".

Materials

Chrome-plated steel base, chromed die-cast aluminium lamp body, Injection-moulded engineering-plastics frame.

Specification

The main indirect emission LEDs are located in the upper part of the fitting. The secondary ambient emission LEDs are located on its base and highlight the three-dimensional inner part of the column. The two switches can be controlled separately.

«Ce produit sophistiqué de grande valeur joue avec des formes géométriques fluides empruntées à la botanique, pour créer un nouveau type d'éclairage dans l'espace qui lance des faisceaux de lumière et d'ombres sur les murs et les surfaces environnantes, interprétant ainsi à merveille le concept de la tridimensionnalité».

Matériaux

Base en acier chromé. Corps en aluminium galvanisé chromé, structure en technopolymère moulé par injection.

Spécificité

Les LED de l'émission indirecte principale se trouvent dans la partie supérieure de la lampe. Les LED de l'émission secondaire, d'ambiance se situent sur la base et dessinent l'intérieur de la colonne en soulignant ainsi son caractère tridimensionnel. Les deux émissions peuvent être gérées séparément.

"Dieses hochwertige, innovative Produkt spielt mit flüssigen Geometrien der Botanik und definiert eine neue Art des Lichts. Licht und Schatten werden in einer einzigartigen Dreidimensionalität auf Wände und Oberflächen projiziert".

Materialien

Sockel aus verchromtem Stahl. Leuchtenkörper aus Lackierter Aluminiumdruckguss, Die Leuchtenstruktur ist aus Spritzguss-Tecnopolymer

Spezifikation

Die LED für den überwiegenden, indirekten Lichtaustritt befindet sich im oberen Teil der Leuchte. Die LED am Sockel, die direktes Licht abgibt, zeichnet das Säulennere nach und hebt so dessen Dreidimensionalität hervor. Der indirekte und direkte Lichtaustritt sind getrennt schaltbar.

"Este producto puntero y de gran valor juguetea con geometrías vegetales fluidas, para definir un nuevo tipo de iluminación en el espacio: los haces de luz y las sombras, que se cruzan sobre las paredes y las superficies, plasman el concepto de tridimensionalidad".

Materiales

Pie de acero cromado; cuerpo de la lámpara en aluminio comprimido cromado, estructura de tecnopolímero moldeado por inyección

Especificaciones

Los LEDs de la emisión indirecta principal están situados en la parte superior de la lámpara. Los LEDs de la emisión secundaria (de ambiente) están instalados en el pie y dibujan el interior de la columna subrayando su tridimensionalidad. Los dos encendidos se manejan por separado.

Light emission



Colour



Polished white



LED



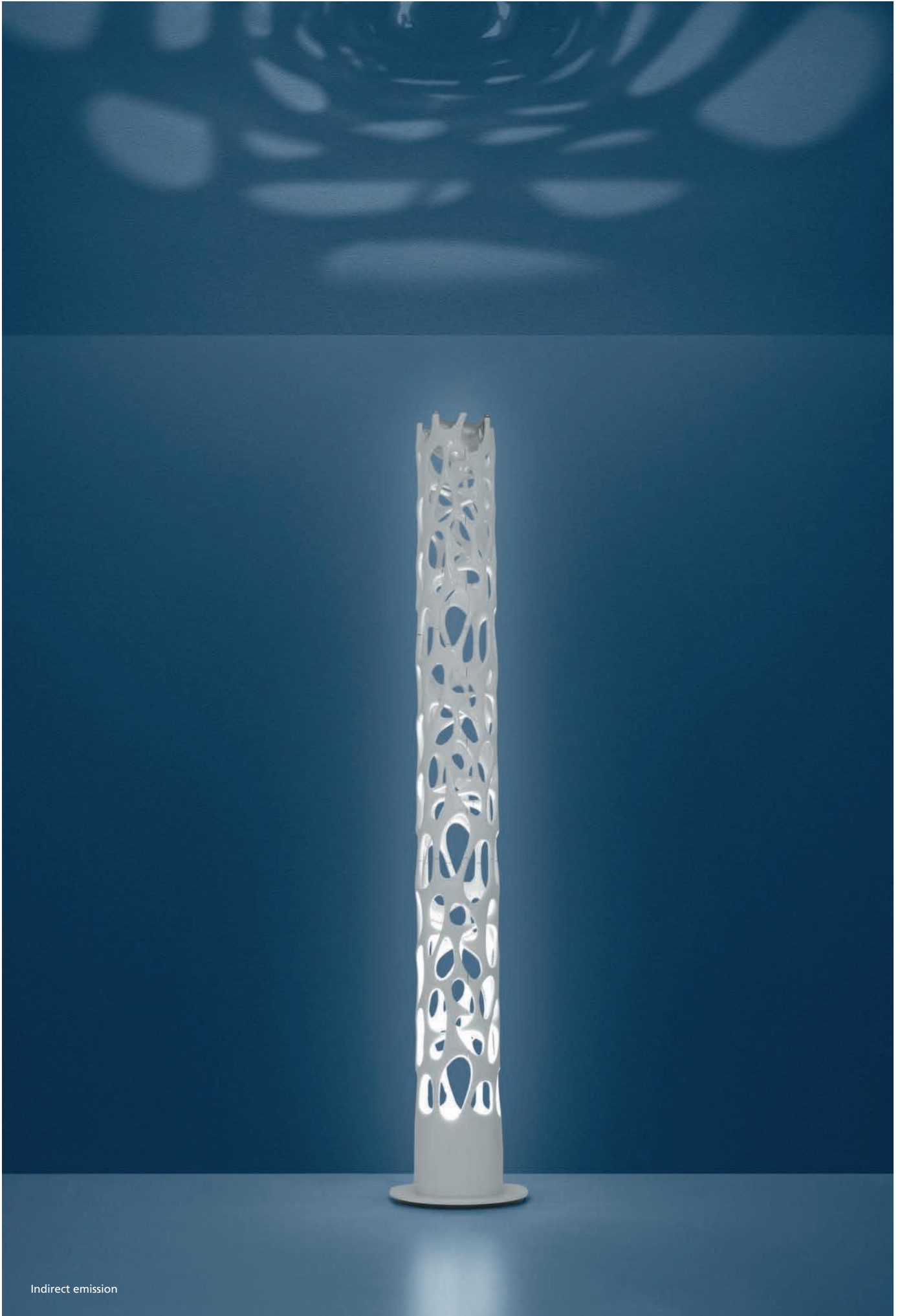

Indirect emission

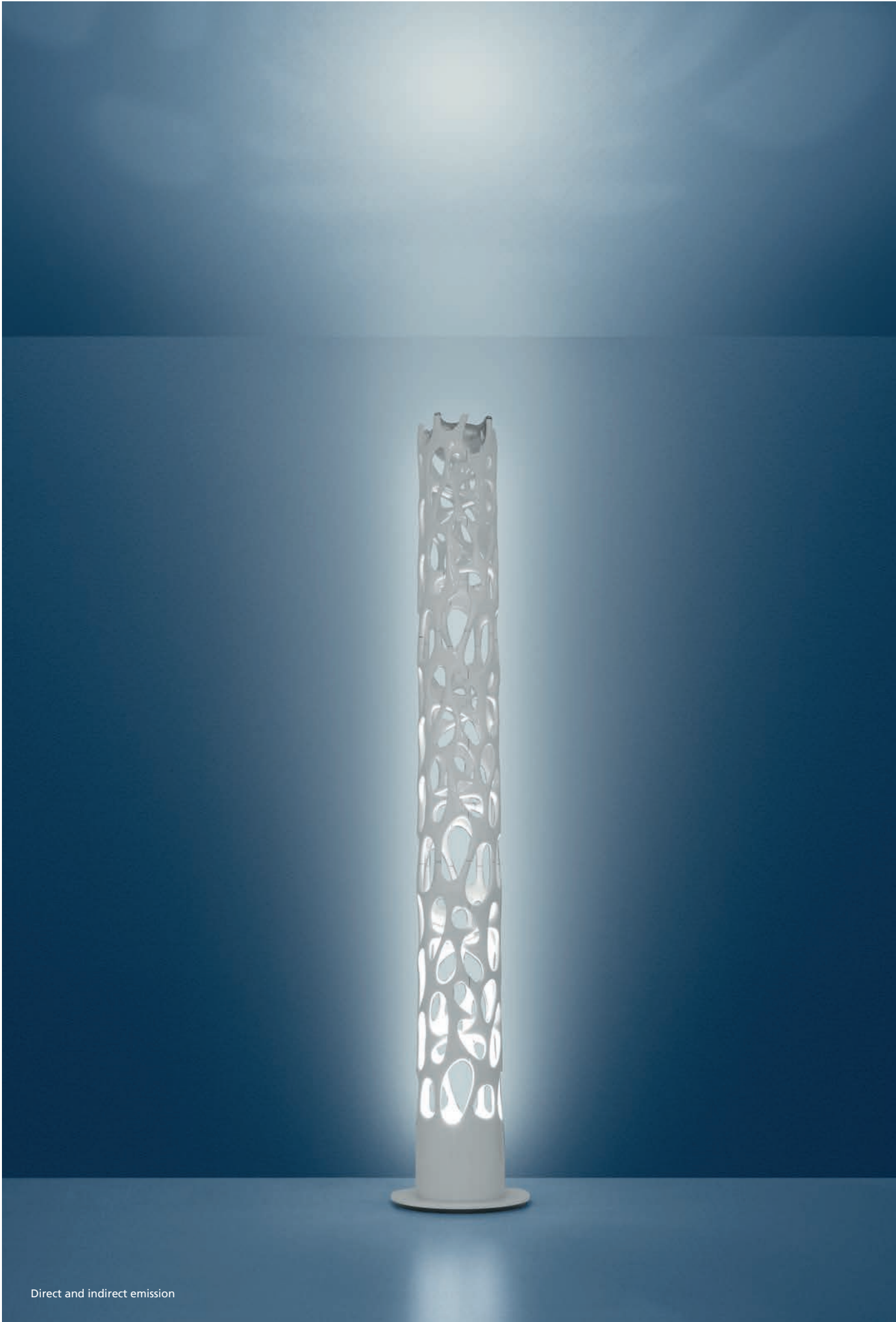

Direct and indirect emission

Cadmo LED Cadmo

Karim Rashid
2006

Materiali

Corpo lampada in acciaio verniciato, base in acciaio con copribase verniciato.

Materials

Painted steel body lamp; inox-steel base with painted cover.

Matériaux

Corps en acier verni ; base en acier inox verni.

Materialien

Leuchtenkörper aus lackiertem Stahl; Sockel aus Edelstahl mit lackierter Oberfläche.

Materiales

Cuerpo de la lámpara de acero; base de acero inox con cubierta pintada.

Awards

2010 – iF Produkt Design Award
Hannover (Deutschland)
Good Design Award
The Chicago Athenaeum
Chicago (US)

Light emission



Colours





436

LED

LED



Con un unico materiale e un unico momento produttivo si genera una sintesi tra la struttura e l'ottica.

Materiali

Corpo lampada stampato in tecnopolimero con finitura verniciata; base in acciaio verniciato.

Specificità

Il corpo della lampada svolge la funzione di riflettore e accoppiato con un'ottica dedicata, permette di performare una luce diffusa con grande efficienza.

From a manufacturing process of a single material, a fusion of frame and optical unit.

Materials

Lamp body in painted technopolymer; base in painted steel.

Specification

The lamp body works as a reflector which, together with a dedicated optical unit, achieves a high efficiency while diffusing light.

Un seul matériau et un seul procédé d'usinage génèrent une synthèse entre structure et optique.

Matériaux

Corps en techno-polymère verni ; base en acier verni.

Spécificités

Le corps garantit une fonction de réflecteur et associé avec une optique dédiée, permet d'améliorer la performance par le biais d'une lumière diffuse et efficace.

Ein einziges Material verarbeitet in einem einzigen Produktionsschritt lässt eine Synthese zwischen Struktur und Optik entstehen.

Materialien

Leuchtenkörper aus lackierter Technopolymer; Sockel aus lackiertem Stahl.

Spezifikation

Der Leuchtenkörper fungiert als Reflektor und erzeugt in Verbindung mit einer speziell entwickelten Optik diffuses Licht von hoher Effizienz.

Con un único material y un único proceso productivo se genera una síntesis entre la estructura y la óptica.

Materiales

Cuerpo de la lámpara en tecnopolímero pintado; Base en en acero pintado.

Especificaciones

El cuerpo del aparato en sí funciona como un reflector que, junto con una unidad óptica, se traduce en una alta eficiencia de difusión de luz.





LED



Light emission



Colour



White

Awards

2015 - Reddot Award
Essen (Deutschland)

Mimesi

Carlotta de Bevilacqua
2011

"Luce, spazio architettonico e paesaggio naturale sono gli elementi principali di questo progetto, fondato su principi di riduzione energetica e materica.

Attraverso la smaterializzazione dei volumi e la trasparenza mimetica, grazie ad una esile struttura di alluminio riciclato e a un corpo in metacrilato, Mimesi non ostacola la visione, integrandosi silenziosamente con l'ambiente circostante".

Materiali

Base in acciaio lucido; struttura in alluminio brillantato lucido; diffusore in tecnopolimero trasparente inciso.

"Light, architectural space and natural landscape are the main elements of this project, based on principles of reduction of energy and materials. Through the dematerialization of volumes and mimetic transparency, and thanks to a slim recycled aluminium structure and methacrylate body, Mimesi does not hinder the vision, but silently integrates with the surrounding environment".

Materials

Base in polished steel; structure in polished aluminium; diffuser in engraved transparent technopolymer.

"La lumière, l'espace architectural et le paysage naturel sont les principaux éléments de ce projet qui se base sur le principe de la réduction de la consommation d'énergie et de matières. À travers la dématérialisation des volumes et la transparence mimétique et grâce à une fine structure de l'aluminium recyclé et à un corps en méthacrylate, Mimesi ne gêne pas la vision et s'intègre silencieusement dans l'espace environnant".

Matériaux

Base en acier poli; structure en aluminium brillant; diffuseur en techno-polymère transparent gravé.

Das Licht, der architektonische Raum und das natürliche Umfeld sind die Grundpfeiler eines Projekts, das sich auf die Zielsetzungen der Energieersparnis und der weitestgehenden Reduzierung der baulichen Werkstoffe richtete.

Durch die Dematerialisierung der Volumen und ein ausgesprochen schlankes, beinahe transparent wirkendes Gerüst aus Recycling-Aluminium und einen eleganten Körper aus Metakryl wird Mimesi niemals zu einem störenden Element im Blickfeld sondern ergänzt sich und verschmilzt auf eine harmonische, vornehm zurückhaltende Weise mit der Umgebung".

Materialien

Sockel aus poliertem Stahl, Struktur aus poliertem Aluminium, Diffusor aus graviertem, transparenten Technopolymer.

"Luz, espacio arquitectónico y paisaje natural son los elementos principales de este proyecto, fundado en principios de reducción energética y materica.

A través de la desmaterialización de los volúmenes y la transparencia mimética, y gracias a una grácil estructura de aluminio reciclado y a un cuerpo de metacrilato, Mimesi no crea obstáculos a la visión y se integra sigilosamente en el ambiente circunstante".

Materiales

Base de acero pulido; estructura de aluminio pulido; difusor de tecnopolimero transparente grabado.

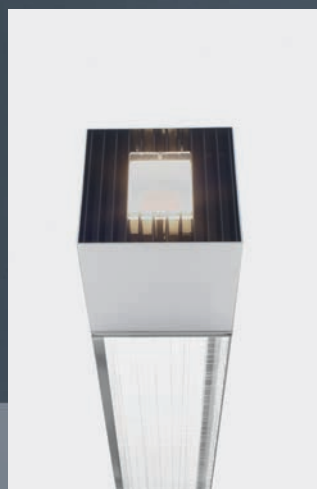

Light emission



Colour



Mirror



LED

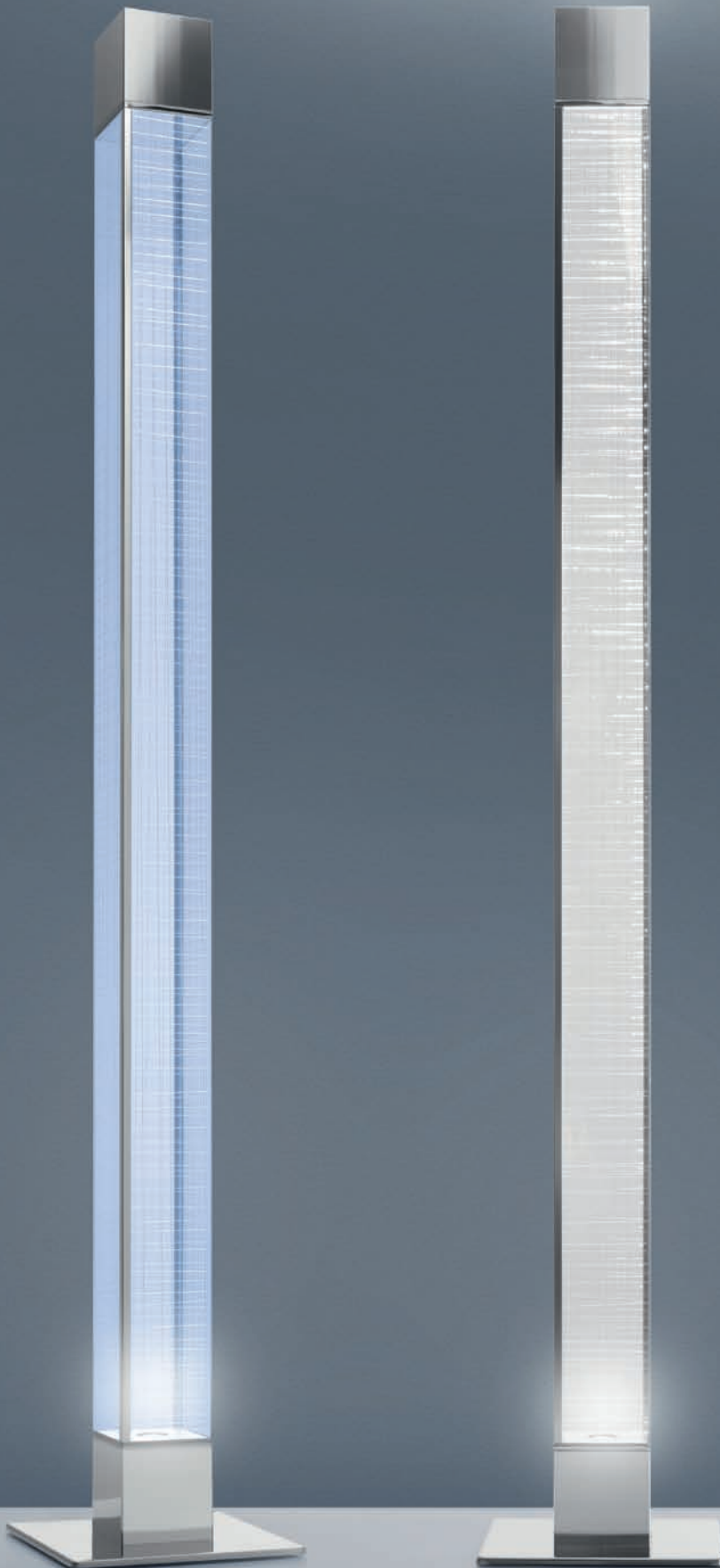

Materiali

Base in acciaio rivestita con tecnopolimero stampato a iniezione; corpo in alluminio verniciato o anodizzato lucido.

Materials

Steel base coated with injection-moulded engineering-plastics; body in painted or polished anodized aluminium.

Matériaux

Base en acier recouvert de technopolymère moulé par injection ; corps en aluminium verni ou anodisé poli.

Materialien

Standfuß aus Stahl mit Spritzguss-Tecopolymer; Gehäuse aus lackiertem oder glänzend eloxiertem Aluminium.

Materiales

Pie de acero, revestido con tecnopolímero moldeado por inyección; cuerpo de aluminio pintado, o anodizado pulido.

Light emission



Colours

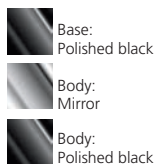

Awards

1981 – Compasso d'Oro / A.D.I.
Segnalazione
Milano (Italia)
1981 – BIO 9 – Honourable mention
Ljubljana (Slovenia)
1987 – Sixth Arango International
Design Exhibition
Miami (US)



LED

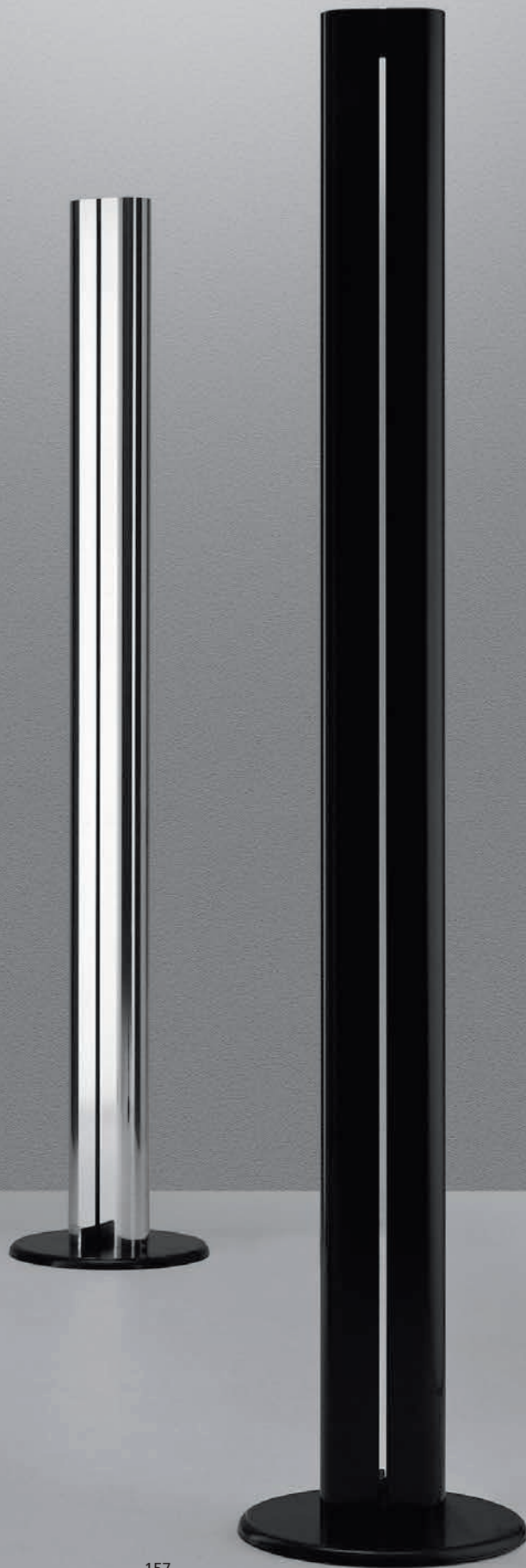

Decomposé light floor

Atelier Oï
2016

Gioca sulla destrutturazione del profilo di base, la luce proiettata attraverso gli anelli in equilibrio disegna sottili ombre nella definizione di una perfetta qualità di luce nello spazio.

Materiali

Alluminio anodizzato.

Featuring a deconstructed base profile, the light projected through the balanced rings designs subtle shadows while defining a perfect quality of light in space.

Materials

Anodized aluminum.

Elle joue sur la déstructuration du profil de base ; la lumière projetée à travers les anneaux en équilibre dessine de fines ombres pour la définition d'une qualité parfaite de la lumière dans l'espace.

Materiaux

Aluminium anodisé.

Sie spielt mit der Destrukturierung vom Basisprofil.

Das durch die ausgeglichenen Ringe projizierte Licht zeichnet dünne Schatten in der Definition einer perfekten Lichtqualität in den Raum.

Materialien

Aluminium eloxiert.

Juega con la desestructuración del perfil de base, la luz proyectada a través de los anillos en equilibrio diseña sombras finas en la definición de una calidad perfecta de la luz en el espacio.

Materiales

Aluminio anodizado.

Light emission



Colours



Fumé



Red



Orange



Gold



134



306



504



LED



Materiali

Pressofusione di alluminio con finitura brillantata lucida.

Specificità

Un'unica sorgente LED di ultima generazione garantisce gli stessi valori di illuminamento ottenibili con una 400W alogena. Leggerezza visiva e termodinamica sono le caratteristiche principali di questo progetto: la testa pressofusa è opportunamente sagomata e traforata per rappresentare un'interfaccia visiva permeabile nello spazio in cui si colloca e agevolare lo scambio termico della sorgente, garantendone una dissipazione ottimale del calore; essa ruota su due assi permettendo all'utente di interagire con l'apparecchio e determinare la luce più adatta alle proprie necessità.

Materials

Die-cast chromed aluminium.

Specification

Visual lightness and thermodynamics are the main characteristics of this project: the head, made of die-cast aluminium, is appropriately shaped and perforated to form a permeable visual interface for the space where it is placed and facilitates heat exchange, guaranteeing optimum dissipation of the heat produced by the light source; it rotates on two axes allowing users to interact with the device and to determine easily the light most suited to your needs. A single latest-generation LED light source guarantees the same illuminance values that are obtainable with a 400W halogen.

Matériaux

Aluminium chromé.

Spécificité

La légèreté visuelle et la hermodynamique sont les principales caractéristiques de ce projet. La tête, réalisée en aluminium moulé sous pression, est judicieusement profilée et ajourée pour constituer une interface visuelle et perméable de l'espace dans lequel elle se situe et faciliter l'échange thermique, en garantissant une dissipation optimale de la chaleur produite par la source. Elle tourne sur deux axes, ce qui permet à l'utilisateur d'agir sur l'appareil et de trouver aisément la lumière la mieux adaptée à ses propres besoins. Une seule source LED de dernière génération fournit les mêmes valeurs d'éclairage que l'on peut obtenir avec une lampe halogène de 400W.

Materialien

Verchromter Aluminiumdruckguss.

Spezifikation

Die Leuchte besticht durch ihre scheinbare Schwerelosigkeit und durch eine ausgeklügelte Thermodynamik. Das Kopfstück aus speziell geformtem und gelochtem Aluminiumdruckguss schafft eine unterbrechungsfreie visuelle Verbindung mit dem Raum und begünstigt den Wärmeaustausch, so dass eine optimale Wärmeableitung erzielt wird. Die auf zwei Achsen rotierende Lichtquelle und gewährleistet so eine gezielte, den individuellen Anforderungen und Gegebenheiten angemessene Lichtemission. Die Leuchten sind mit einer einzigen LED ausgestattet, die die gleiche Leistung wie eine 400W Halogenlampe erbringt.

Materiales

Aluminio cromado.

Especificaciones

Ligereza visual y termodinámica son las características principales de este proyecto: la cabeza, realizada en aluminio moldeado bajo presión, está oportunamente perfilada y perforada para presentar una interfaz visual permeable del espacio en que se coloca y facilitar el intercambio térmico, garantizando una óptima disipación del calor producido por la fuente; gira sobre dos ejes, permitiendo al usuario la interacción con el aparato de modo que decida fácilmente la luz más adecuada a sus necesidades. Una única fuente LED de última generación, garantiza los mismos valores de iluminación que se obtienen con una halógena de 400 W.

Light emission**Colours**

Stem:
Mirror



Head and base:
Mirror



LED

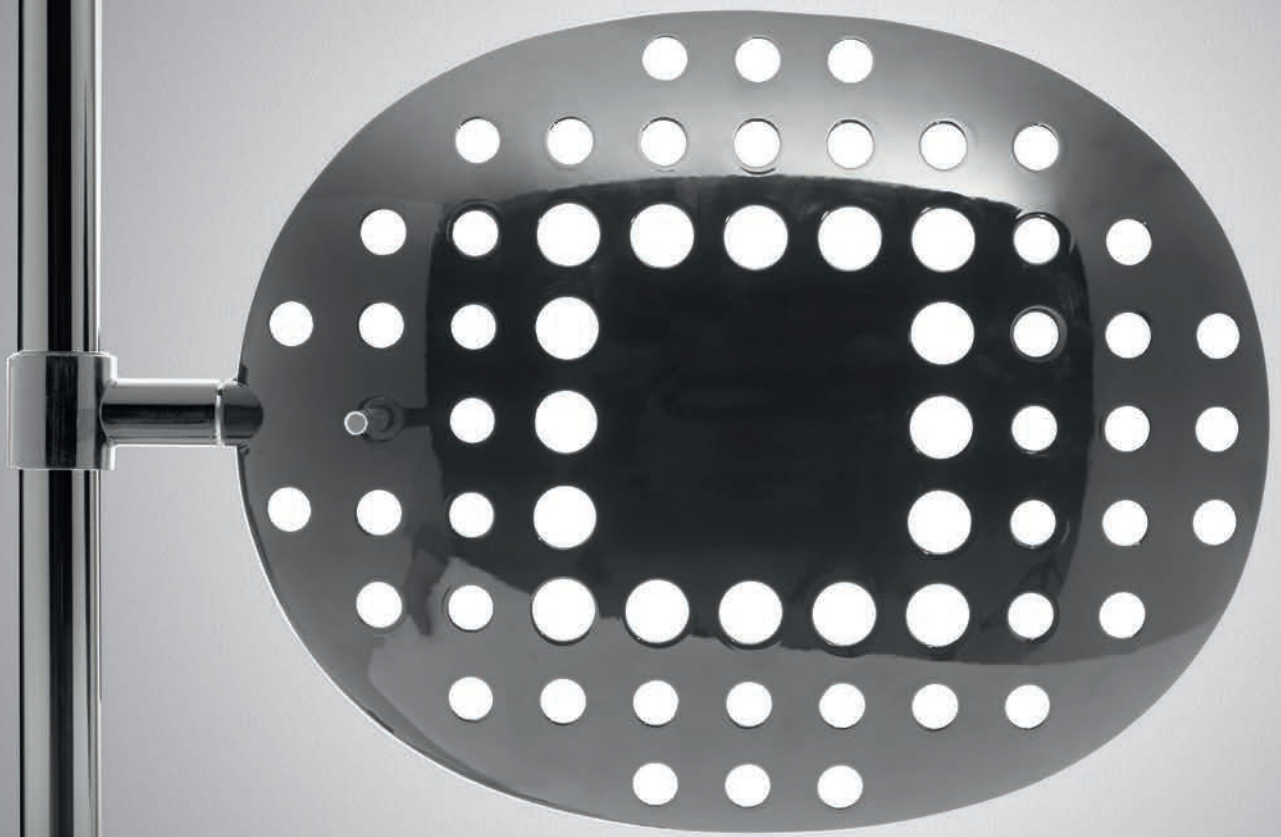





Materiali

Corpo della lampada in alluminio estruso modellato meccanicamente; diffusore in policarbonato trasparente stampato ad iniezione; stelo in alluminio; base in acciaio verniciato.

Materials

Lamp body in extruded aluminum, mechanically moulded; transparent injection-moulded polycarbonate diffuser; aluminium stem; painted steel base.

Matériaux

Corps en aluminium extrudé fraisé ; diffuseur en polycarbonate transparent moulé; tige en aluminium; base en acier verni.

Materialien

Der Leuchtenkörper besteht aus fließgepresstem, formmechanischem Aluminium; der transparente Schirm aus Polycarbonat ist spritzgegossen; Stab aus Aluminium; Sockel aus Edelstahl.

Materiales

Cuerpo de la lámpara en aluminio extruido modelado mecánicamente; difusor en policarbonato transparente estampado a inyección; tija en aluminio pintado; base de acero pintado.

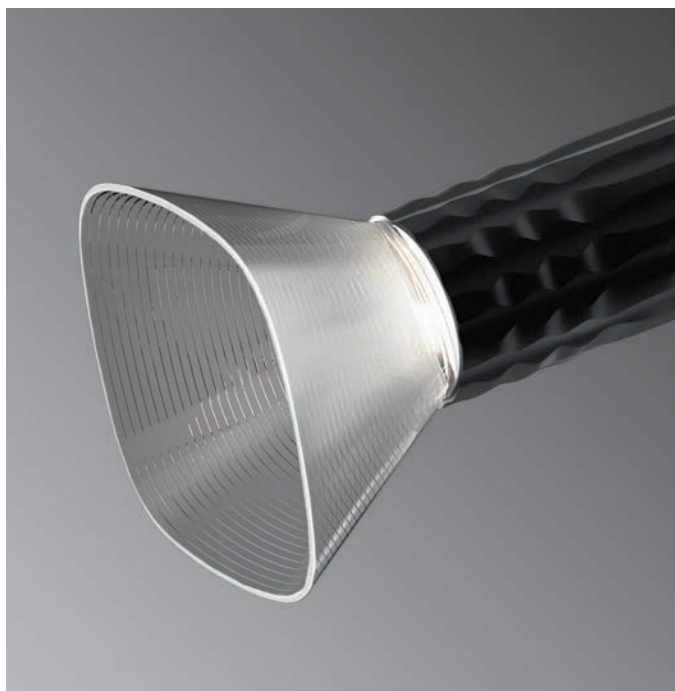

Light emission



Colours





104

272

476

476

LED



Materiali

Corpo della lampada in alluminio estruso modellato meccanicamente.

Specificità

All'interno del corpo cilindrico l'emissione del LED integrato è controllata da un'ottica asimmetrica che direziona la luce per un effetto wall washer.

Materials

Milled aluminium extruded body, mechanically moulded.

Specification

LED emission integrated in the cylinder-shaped body is controlled by an asymmetrical optical unit that directs light to obtain a wall-washer effect.

Matériaux

Corps de la lampe en aluminium extrudé fraisé.

Spécificité

À l'intérieur du corps cylindrique, l'émission du LED intégré est contrôlée par une optique asymétrique qui dirige la lumière pour un effet wall washer.

Materialien

Leuchtenkörper besteht aus fließgepresstem, formmechanischem Aluminium

Spezifikation

Im Inneren des zylindrischen Körpers ist die Lichtemission der integrierten LED von einer asymmetrischen Leuchte gesteuert, welche das Licht für ein Wall Washer-Effekt ausrichtet.

Materiales

Cuerpo lámpara de aluminio extruido modelado.

Especificaciones

En el interior del cuerpo cilíndrico la emisión del LED integrado está controlada por una óptica asimétrica que dirige la luz para un efecto wall washer.



Light emission



Colours

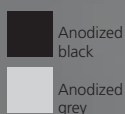



Demetra reading floor Demetra professional reading floor

Naoto Fukasawa
2013

Materiali

Corpo della lampada in pressofusione di alluminio verniciato; bracci e snodi in alluminio con finitura verniciata; base in acciaio con copribase in tecnopolimero verniciato.

Demetra lettura MD

In questa versione è presente un sensore Movement detector, che gestisce l'accensione dell'apparecchio a seconda della vicinanza dell'utente.

Materials

Painted die-cast aluminium body lamp; arms in painted aluminium; inox-steel base with painted technopolymer cover.

Demetra MD

This model features a Movement detector option detecting moving objects and people and turning the light on or off accordingly.

Matériaux

Corps en aluminium moulé sous pression peint ; bras en aluminium verni ; base en acier inox verni avec une couverture en techno-polymère.

Demetra MD

Cette version est dotée d'un détecteur de mouvement qui gère l'allumage de l'appareil selon la présence ou non de l'utilisateur.

Materialien

Leuchtenkörper aus druckgegossenem, lackiertem Aluminium; Arme aus lackiertem Aluminium; Sockel aus Edelstahl mit Oberfläche beschichtete Technopolymer.

Demetra MD

Diese Version der Tischleuchte ist mit einem Bewegungsmelder ausgestattet.

Materiales

Cuerpo de la lámpara en aluminio fundido a presión y pintado; brazos en aluminio pintado; base de acero inox con cubierta en polímero pintada.

Demetra MD

En esta versión existe un sensor de detección de Movimiento: que gestiona el encendido del aparato según la proximidad del individuo.

Awards

2014 - Design plus
Light+Building Award
Frankfurt (Deutschland)

MD Movement detector



12' 2,5 mt

Light emission



Colours

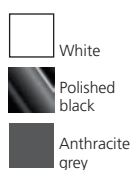

Demetra Professional



Dimmer on top

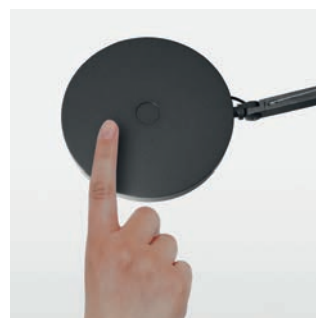

Movement detector





Tizio floor support

Tizio
Tizio LED
Tizio 35

Richard Sapper
1980

Materiali

Base in acciaio e corpo in estruso di alluminio verniciato.

Specificità

Supporti terra per il sostegno delle lampade Tizio, Tizio LED, e Tizio 35.

Materials

Steel base and painted aluminium extruded body.

Specification

Floor supports for Tizio, Tizio LED, Tizio 35 fittings.

Matériaux

Base en acier et corps de la lampe en aluminium extrudé et verni.

Spécificité

Support pour Tizio, Tizio LED, Tizio 35.

Materialien

Standfuß aus Stahl, Leuchtenkörper aus extrudiertem Aluminium.

Spezifikation

Säule für die Leuchten Tizio, Tizio LED, Tizio 35.

Materiales

Pie de acero, cuerpo lámpara de aluminio extruido y pintado.

Especificaciones

Soportes de pie para la sujeción de las lámparas Tizio, Tizio LED y Tizio 35.

Colour



Black



Talak professional reading floor

Neil Poulton
2007

Materiali

Base in acciaio verniciato; stelo in acciaio cromato lucido; corpo lampada in estruso di alluminio verniciato.

Specificità

Il corpo lampada ruota di 360° sul piano orizzontale ed è regolabile in altezza.

Materials

Base in painted steel; polished chromed steel stem; painted aluminium extruded body.

Specification

The body lamp rotates 360° on the horizontal plane and its height can be adjusted.

Matériaux

Base en acier peint; tige en acier poli chromé, corps de la lampe en aluminium extrudé et verni.

Spécificité

Le corps de la lampe s'oriente jusqu'à 360° sur le plan horizontal et se règle en hauteur.

Materialien

Sockel aus lackiertem Stahl; Stab aus Stahl, Chrom poliert; Leuchtenkörper aus lackiertem, fließgepresstem Aluminium.

Spezifikation

Der Leuchtenkörper kann horizontal um 360° gedreht werden und ist höhenverstellbar.

Materiales

Base en acero pintado; tija en acero cromado brillante; cuerpo lámpara de aluminio extruido y pintado.

Especificaciones

El cuerpo de la lámpara gira a 360° en sentido horizontal y es regulable en altura.

Light emission



Colours

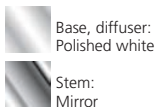



Materiali

Base e stelo in acciaio; corpo lampada in alluminio pressofuso verniciato.

Materials

Steel base and stem; body lamp in painted die-cast aluminium.

Matériaux

Base et tige en acier ; corps en aluminium moulé sous pression peint.

Materialien

Sockel und Stab aus Stahl; Leuchtenkörper aus druckgegossenem, lackiertem Aluminium.

Materiales

Pie y tija en acero; cuerpo de la lámpara en aluminio fundido a presión y pintado.

Light emission



Colour



Awards

2008 – Good Design Award
The Chicago Athenaeum
Chicago (US)

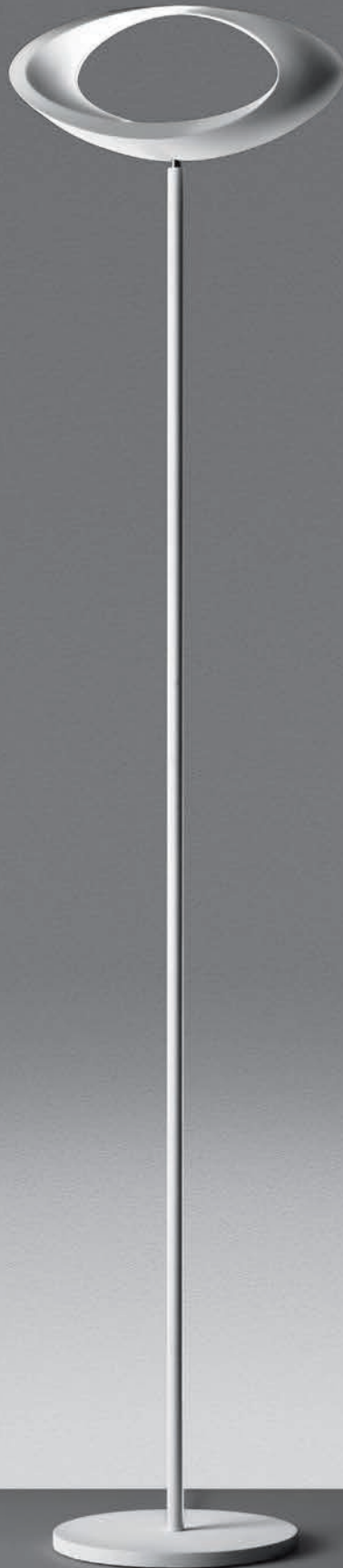

Cosmic Leaf

Ross Lovegrove
2009

Materiali

Struttura in acciaio cromato; corpo lampada-diffusore in metacrilato trasparente texturizzato; corpo illuminante in metallo verniciato.

Materials

Chromed steel structure; body lamp-diffuser in transparent methacrylate with texture; painted metal lighting unit.

Matériaux

Structure en acier chromé ; corps diffuseur en méthacrylate transparent tissé ; corps lumineux en métal peint.

Materialien

Gestell aus verchromtem Stahl, Leuchtenkörper aus transparentem, strukturiertem Methacrylat; Beleuchtungseinheit aus lackiertem Metall.

Materialies

Estructura en metal cromado; cuerpo de la lámpara-difusor en metacrilato transparente texturizado, cuerpo luminoso en metal pintado.

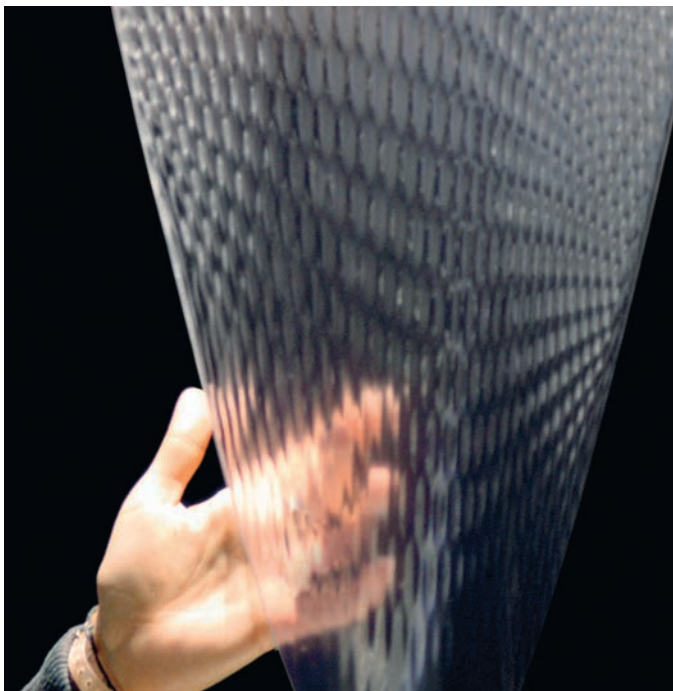

Light emission



Colours



Diffuser:
Transparent



Lighting unit:
Grey

Awards

2010 – Good Design Award
The Chicago Athenaeum
Chicago (US)

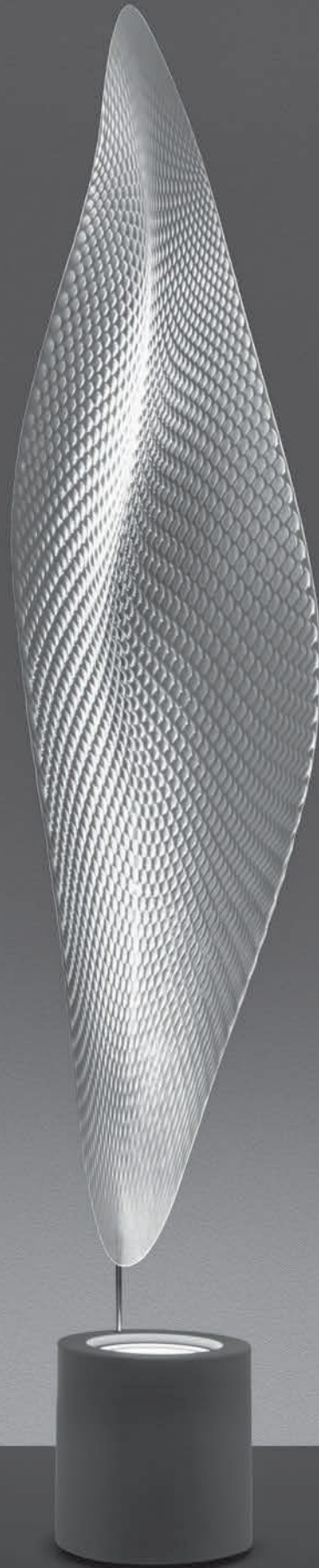

La parabola, con la sua innovazione ottica brevettata, costituisce il punto centrale del progetto e permette di gestire la luce nello spazio.

Materiali

Metallo, metacrilato.

Specificità

Si compone di un corpo ottico posto all'interno di un riflettore a parabola con una distanza minima tra i due elementi calcolata per evitare punti d'ombra. Lo snodo consente di direzionare il corpo ottico verso il riflettore o direttamente nell'ambiente.

Featuring an innovative patented optical unit, the parabola is the core of the project and allows to manage light in space.

Materials

Metal, methacrylate.

Specification

It consists of an optical unit fitted inside a parabolic reflector with a minimum distance between both elements calculated in order to prevent any dark spots. The joint allows to direct the optical unit towards the reflector or straight into the environment.

La parabole, par son innovation optique brevetée, constitue le point central du projet et permet de gérer la lumière dans l'espace.

Matériaux

Métal, méthacrylate.

Spécificité

Composée d'un corps optique placé à l'intérieur d'un réflecteur à parabole avec une distance minimale entre les deux éléments, calculée pour éviter des points d'ombre. L'articulation permet de diriger le corps optique vers le réflecteur ou directement dans l'espace.

Der Parabolspiegel mit seiner patentierten Lichtinnovation bildet den zentralen Punkt des Projekts und ermöglicht, das Licht im Raum zu steuern.

Materialien

Metall, Methacrylat.

Spezifikation

Sie besteht aus einem Leuchtkörper innerhalb eines Parabolspiegels mit einem Mindestabstand zwischen den beiden berechneten Elementen, um Schattenbereiche zu vermeiden. Das Gelenk ermöglicht es, die optische Einheit zum Reflektor oder direkt in die Umgebung zu richten.

El reflector parabólico, con su innovación óptica patentada, constituye el punto central del proyecto y permite gestionar la luz en el espacio.

Materiales

Metal, metacrilato.

Especificaciones

Está compuesto por un cuerpo óptico situado en el interior de un reflector parabólico con una distancia mínima entre los dos elementos calculada para evitar puntos de sombra. L'articulación permite de dirigir el cuerpo óptico hacia el reflector mismo o directamente en el ambiente.

Light emission



Colour



Diffuser:
Transparent

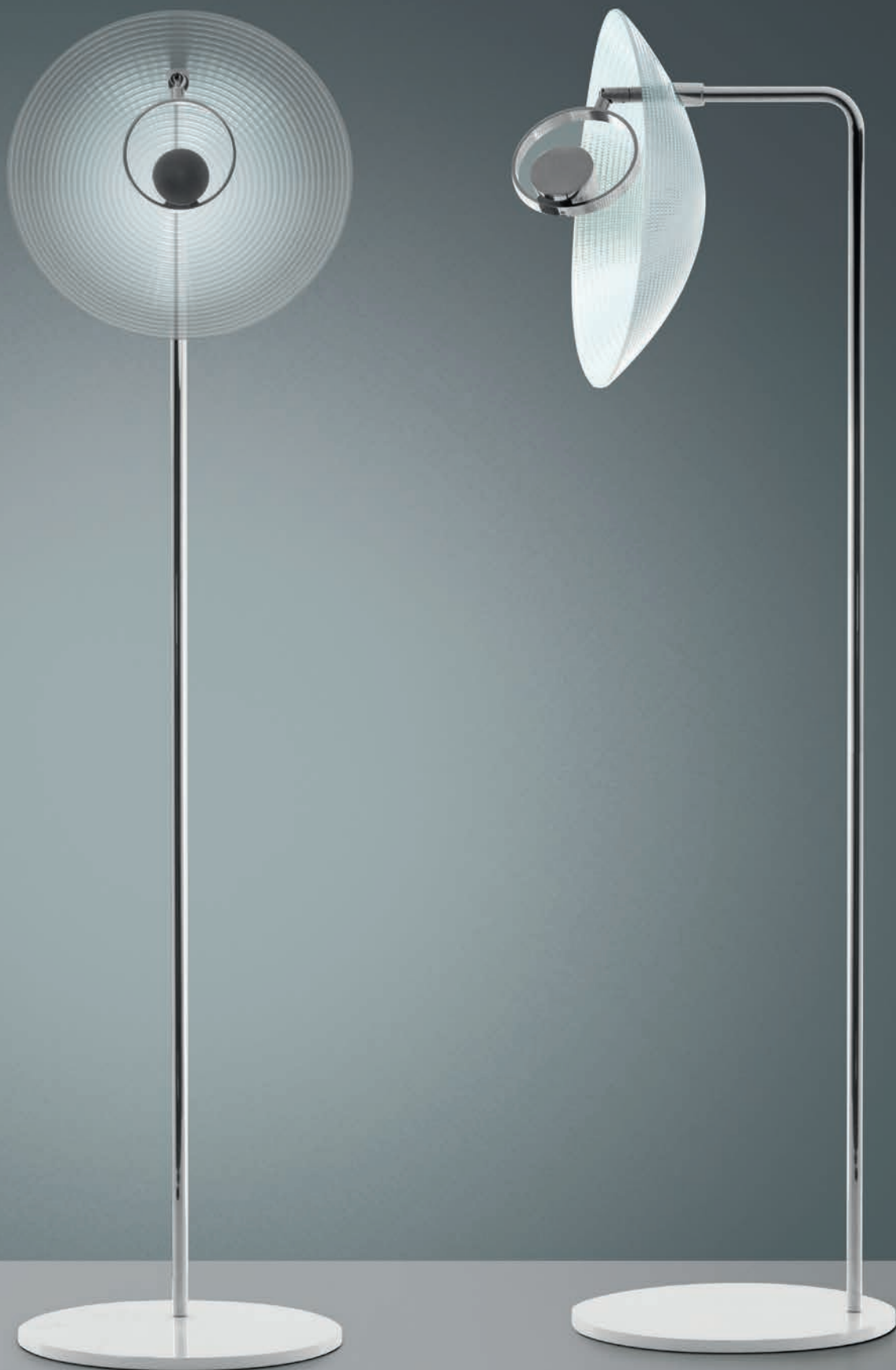

Materiali

Diffusore in vetro borosilicato con sabbiatura antiabbagliamento; base e stelo in acciaio verniciato.

Specificità

Il diffusore è costituito da due coni sovrapposti, uno interno in metallo nero, uno esterno trasparente in vetro borosilicato soffiato. I due elementi producono un contrasto estetico, ma agiscono insieme per dar forma, dirigere e diffondere la luce. Il diffusore può essere regolato in altezza con un sistema saliscendi.

Materials

Borosilicate glass diffuser, sand-blasted to prevent glaring; painted steel base and stem.

Specification

The diffuser consists of two overlapped cones, an inner black-metal one, and an outer clear blown borosilicate glass one. Both elements produce a contrasting look, while interacting to give shape, direct, and diffuse light. The diffuser's height can be adjusted by means of a rise and fall system.

Matériaux

Diffuseur en verre borosilicaté sablé anti-éblouissement ; base et tige en acier verni.

Spécificité

Le diffuseur est formé de deux cônes superposés, l'un intérieur en métal noir, l'un extérieur transparent en verre borosilicaté soufflé. Les deux éléments produisent un contraste esthétique mais agissent ensemble pour donner forme à la lumière, la diriger et l'orienter. Le diffuseur peut être réglé en hauteur par un système approprié.

Materialien

Diffusor aus Borosilikatglas mit Blendschutz-Sandstrahlen; Leuchtenbasis und -stab aus lackiertem Stahl.

Spezifikation

Der Diffusor besteht aus zwei überlagerten Kegeln, einer innen aus schwarzem Metall, einer außen transparent aus geblasenem Borosilikatglas. Die beiden Elemente erzeugen einen ästhetischen Kontrast, wirken aber zusammen, um das Licht zu formen, auszurichten und zu verteilen. Der Diffusor kann mit einem verschiebbaren System reguliert werden.

Materiales

Difusor de vidrio borosilicato con arenación antirreflejo; base y pie de acero pintado.

Especificaciones

El difusor está compuesto por dos conos superpuestos, uno interno de metal negro, uno externo transparente de vidrio borosilicato soplado. Los dos elementos producen un contraste estético, pero actúan juntos para dar forma, dirigir y difundir la luz. El difusor se puede ajustar en altura con un sistema sube y baja.

Light emission



Colours



Black



Diffuser:
Transparent



Sette steli flessibili fungono da guida di luce ai LED posti alla base, creando una scenografica presenza luminosa.

Materiali

Base in alluminio verniciato, corpo della lampada in tecnopolimero trasparente ricoperto da una copertura plastica colorata in massa; steli in PMMA trasparente.

Specificità

La forma della base si presta alla componibilità e alla realizzazione di combinazioni multiple personalizzate.

Seven flexible stems work as light tubes for the LEDs located at its base, creating a picturesque lighting trail.

Materials

Base in painted aluminium; lamp body in transparent technopolymer covered with a body-tinted plastic cover; stems in transparent PMMA.

Specification

The shape of the base allows modular installations and multiple customized configurations.

Il s'agit de sept tiges flexibles faisant office de guide lumière aux LED positionnés dans la base, créant ainsi une présence lumineuse scénographique.

Matériaux

Base en aluminium verni, corps en techno-polymère transparent recouvert d'une couche en plastique colorée dans la masse ; tiges en PMMA transparent.

Spécificités

La forme de la base permet de réaliser des combinaisons multiples.

Sieben flexible Stäbe dienen als Lichtleiter für die LEDs, die sich am Sockel befinden, und erzeugen eine außergewöhnliche Lichtstimmung.

Materialien

Sockel aus lackiertem Aluminium; Leuchtenkörper aus Technopolymer mit Kunststoff-abdeckung; Stäbe aus transparentem PMMA.

Spezifikation

Die Form des Sockels ermöglicht die Kombination von mehreren Leuchtenmodulen.

Siete tallos flexibles sirven de guía de luz a los LED situados en la base, creando una escenográfica presencia luminosa.

Materiales

Base en aluminio pintado; cuerpo de la lámpara en tecnopolimero transparente cubierta con una tapa de plástico; tijas en PMMA transparente.

Especificaciones

La forma de la base se presta a la composición y a la realización de combinaciones múltiples personalizadas.

Light emission



Colours





LED

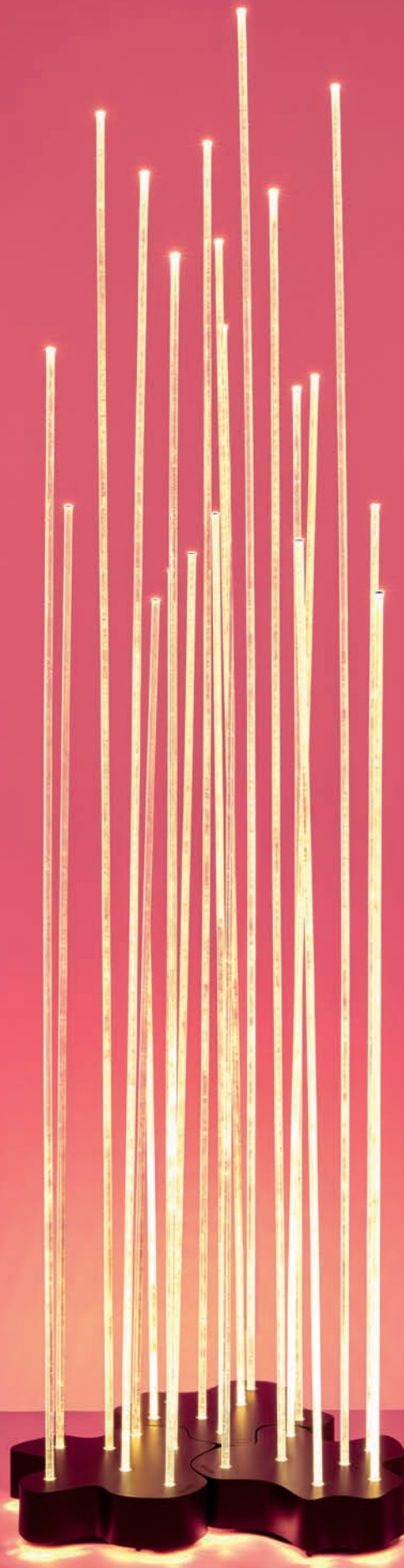

Empatia 26 floor

Carlotta de Bevilacqua
Paola di Arianello
2013

Materiali

Corpo della lampada in pressofusione di alluminio con finitura verniciata; diffusore in vetro soffiato trasparente con finitura seta lucida; guida luce in metacrilato a basso coefficiente di assorbimento; piastra di fissaggio del vetro in alluminio verniciato; base e stelo in acciaio verniciato.

Materials

Painted die-cast aluminium body lamp; arms in painted aluminium; diffuser in blown glass with polished-silk finish; light pipe made of low absorption coefficient methacrylate; glass back plate in painted aluminium; base and stem in painted steel.

Matériaux

Corps en aluminium moulé sous pression peint ; diffuseur en verre soufflé transparent avec finition en soie brillante ; guide lumière en méthacrylate à bas coefficient d'absorption ; plaque de fixation du verre en aluminium verni ; base et tige en acier verni.

Materialien

Leuchtenkörper aus druckgegossenem, lackiertem Aluminium; Schirm aus transparentem, mundgeblasenem Glas in seidig glänzendem Finish; Lichtstab aus Methacrylat mit niedrigem Absorptionskoeffizienten; Befestigungsplatte für das Glas aus lackiertem Aluminium; Sockel und Leuchtenstab aus Stahl.

Materialies

Cuerpo de la lámpara en aluminio fundido a presión y pintado; difusor en cristal soplado transparente con acabado seda lúcido; guía de luz en metacrilato de bajo coeficiente de absorción; plancha de fijación del cristal en aluminio pintado; pie y tija en acero pintado.

Light emission



Colour



Awards

2014 – Wallpaper Design Awards
2014 – iF Product Design Award
Deutschland





114



338



482



482



LED



Meteorite 35 floor

Pio & Tito Toso
2014

Materiali

Diffusore in vetro soffiato; corpo della lampada in tecnopolimero; base e stelo in acciaio cromato.

Materials

Blown glass diffuser; body lamp in technopolymer; base and stem in chromed steel.

Matériaux

Diffuseur en verre soufflé ; corps en techno-polymère ; base et tige en acier chromé.

Materialien

Schirm aus mundgeblasenem Glas; Leuchtenkörper aus Technopolymer; Sockel und Leuchtenstab aus Verchromtem Stahl.

Materiales

Difusor en cristal soplado; cuerpo de la lámpara en tecnopolímero; base y tija en acero cromado.



Light emission



Colour



Diffuser:
White



Stem:
Mirror

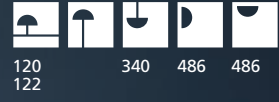

120
122

340

486

486

LED



Light On

Castore 35 floor

Michele De Lucchi
Huub Ubbens
2003

Materiali

Base in zama; stelo in policarbonato; diffusore in vetro soffiato.

Specificità

Un tasto d'accensione touch, presente sullo stelo, permette la regolazione dell'intensità luminosa, la memorizzazione dell'ultimo livello di luce impostato e la possibilità di scegliere tra comando locale e comando remoto (presa comandata).

Materials

Base in zamak, stem in polycarbonate, blown glass diffuser.

Specification

A touchdimmer button on the stem memorizes the last inputted light intensity and allows the choice of a local or remote control.

Matériaux

Base en zamak, tige en polycarbonate, diffuseur en verre soufflé.

Spécificité

Castore 35 et 42 sont dotés d'un variateur sensible, situé sur la tige pour la mémorisation du dernier niveau d'intensité lumineuse établi et la possibilité de choisir entre la commande déportée (interrupteur) ou directement sur le luminaire.

Materialien

Fuß aus Zamak, Stab aus Polycarbonat, Schirm aus mundgeblasenem Glas.

Spezifikation

Ein Touch Dimmer am Stab der Leuchte ermöglicht die Regelung sowie die Speicherung der Lichtintensität und bietet außerdem die Möglichkeit, zwischen Hand- und Fernbedienung zu wählen (Steckdosenschalter).

Materiales

Base en zamak, tija en policarbonato, difusor en cristal soplado.

Especificaciones

Una tecla que enciende por contacto y que se encuentra en el cuerpo, permite la regulación de la intensidad luminosa y la memorización del último nivel de intensidad configurado y la posibilidad de elegir entre mando exclusivamente local y mando a distancia (toma accionada).

Touch dimmer

Functions:

1. Memo
2. Reset

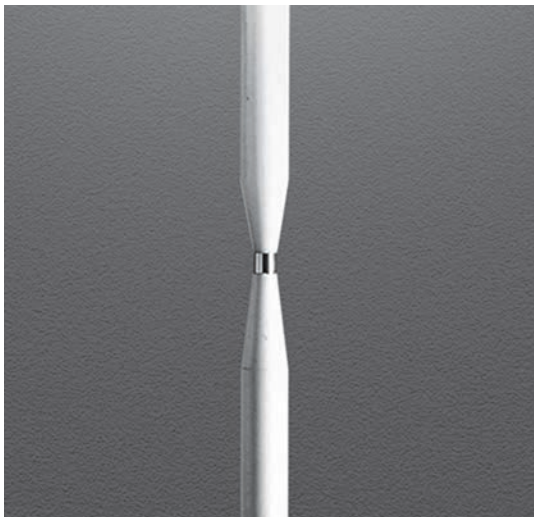

Light emission



Colour



White

Awards

2004 – Design Plus, Light + Building
Frankfurt am Main (Deutschland)
2004 – Reddot Design Award
Essen (Deutschland)
2004 – Compasso d'Oro / A.D.I.
Segnalazione – Milano (Italia)



124



342



LED



La Petite floor

Andrea Quaglio
Manuela Simonelli
2016

Un archetipo paralume in equilibrio su uno stelo inclinato crea una bilanciata composizione geometrica che stupisce pur nella sua semplicità. Le forme elementari sono combinate a materiali diversi per ragioni tecnologiche.

Materiali

Struttura in alluminio, diffusore in metacrilato.

Specificità

Il paralume è un leggero volume plastico chiuso da due diffusori che producono una piacevole morbida luce diretta e indiretta.

An archetypal lampshade fitted on a tilted stem creates a surprising well-balanced, yet very simple geometric composition. Its basic forms are combined with a variety of materials for technological reasons.

Materials

Aluminium frame, methacrylate diffuser.

Specification

The lampshade is a lightweight plastic body closed by two diffusers that produce a pleasant soft direct and indirect light.

Un archétype d'abat-jour en équilibre sur une tige inclinée crée une position géométrique équilibrée qui surprend par sa simplicité. Ses formes élémentaires sont associées à des matières différentes pour des raisons technologiques.

Matériaux

Structure en aluminium, diffuseur en méthacrylate.

Spécificité

L'abat-jour est un léger volume plastique fermé par deux diffuseurs qui produisent une lumière douce et agréable, directe et indirecte.

Ein Archetyp des Lampenschirms auf einem geneigten Stab erzeugt eine ausgewogene geometrische Komposition, die trotz ihrer Einfachheit überrascht. Die Grundformen werden aus technischen Gründen mit verschiedenen Materialien kombiniert.

Materialien

Aluminiumstruktur, Diffusor aus Methacrylat.

Spezifikation

Der Lampenschirm besteht aus einem leichten Kunststoff-Volumen, geschlossen von zwei Diffusoren, die ein angenehm weiches direktes und indirektes Licht erzeugen.

Una pantalla arquetipo en equilibrio en un pie inclinado crea una composición geométrica equilibrada que sorprende a pesar de su sencillez. Las formas elementales están combinadas con materiales diferentes por razones tecnológicas.

Materiales

Estructura de aluminio, difusor de metacrilato.

Especificaciones

La pantalla es un ligero volumen plástico cerrado por dos difusores que producen una agradable y suave luz directa e indirecta.

Light emission



Colours



Polished white



Polished black





102



442



LED

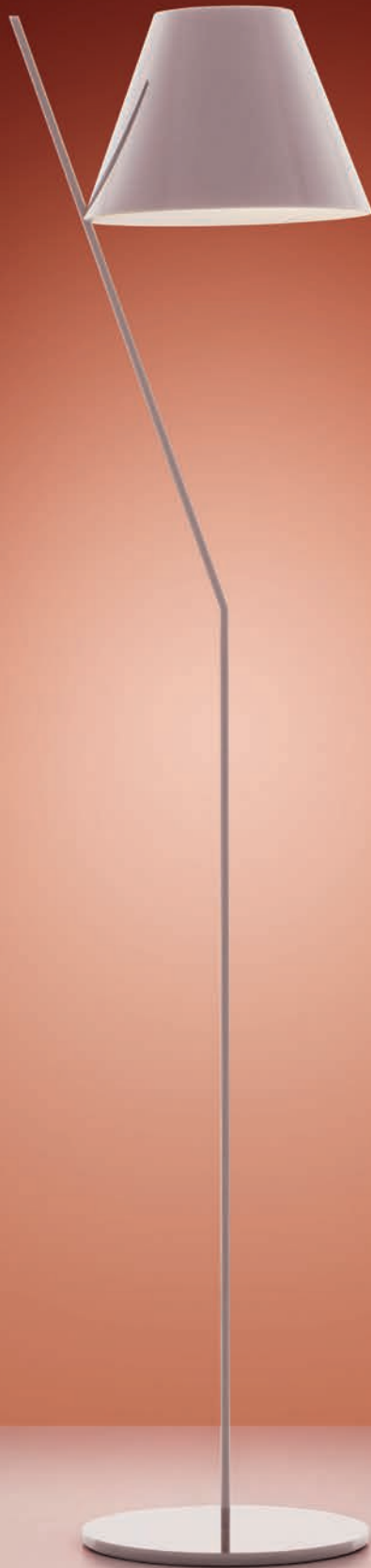

Melampo floor Melampo mega floor

Adrien Gardère
2000

Materiali

Base in zama verniciata; stelo in alluminio verniciato; diffusore in raso di seta, supportato da tecnopolimero.

Specificità

Diffusore orientabile in tre diverse posizioni.

Materials

Base in painted zamac; painted aluminium stem; diffuser in silk satin fabric on a technopolymer frame.

Specification

Adjustable diffuser into three different positions.

Matériaux

Base en zamac peint ; tige en aluminium peint ; diffuseur en techno-polymère recouvert de satin de soie.

Spécificité

Diffuseur orientable dans trois positions différentes.

Materialien

Sockel aus lackiertem Zamak; Stab aus lackiertem Aluminium; Schirm aus Seidensatin (stabilisiert mit Technopolymer).

Spezifikation

Schirm in drei unterschiedliche Positionen verstellbar.

Materialies

Pie de zamak pintado; tija de aluminio pintado; difusor en raso seda reforzado con tecnopolímero.

Especificaciones



Difusor orientable en tres posiciones diferentes.



Light emission



Colours

	Base and stem: Grey
	Diffuser: Grey
	Base and stem: Bronze
	Diffuser: Natural



Choose floor Choose mega floor

Matteo Thun
2006

Materiali

Base in zama; struttura in acciaio cromato; diffusore orientabile in policarbonato accoppiato a un foglio di carta pergamena.

Materials

Base in zamac, chrome-plated steel structure, adjustable diffuser in transparent polycarbonate, joined with parchment paper.

Matériaux

Base en zamac ; structure en en acier chromé ; diffuseur orientable en polycarbonate couplé à une feuille de papier parchemin.

Materialien

Leuchtenfuß aus Zamak; Struktur aus verchromtem Stahl; verstellbarer Schirm aus Polycarbonat mit Pergamentpapier.

Materialies

Pie de zamak; estructura de acero cromado; difusor orientable de policarbonato junto con tela de pergamino.

Light emission



Colours

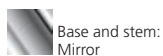

Base and stem:
Mirror



Diffuser:
White



Base and stem:
Mirror



Diffuser:
Natural



Choose mega floor



Choose floor

Tolomeo floor
Tolomeo micro floor
Tolomeo reading floor

Michele De Lucchi
Giancarlo Fassina
1987



Tolomeo floor

Tolomeo reading floor



Patent Pending

n. 11161968.0

Awards

Tolomeo floor
1989 – Compasso d'Oro / A.D.I. Milano (Italia)



Light emission



Colour



Base and structure:
Mirror

Materiali

Base in acciaio rivestita in alluminio e struttura a bracci mobili in alluminio lucidato; diffusore orientabile in tutte le direzioni in alluminio anodizzato opaco; snodi in alluminio brillantato.

Specificità

Disponibile con due snodi in due dimensioni (floor e micro floor) e con uno snodo (reading floor). Sistema di equilibratura a molle.

Materials

Aluminium-coated steel base and cantilevered arms in polished aluminium; diffuser in opaque anodized aluminium adjustable in all directions; joints in polished aluminium.

Specification

Available with two joints and in two sizes (floor and micro floor versions) and with only one joint (reading-floor version). System of spring balancing.

Matériaux

Base en acier revêtue d'aluminium et structure à bras articulés en aluminium poli ; diffuseur, orientable dans toutes les directions, en aluminium anodisé opaque ; articulations en aluminium brillant.

Spécificité

Disponible avec deux articulations en deux tailles (lampadaire et lampadaire micro) et avec une articulation (lampadaire de lecture). Système d'équilibrage à ressorts.

Materialien

Die Stahlbasis ist mit Aluminium beschichtet und ausrichtbare Arme aus glänzendem Aluminium; in alle Richtungen verstellbarer Leuchtenkopf aus matt eloxiertem Aluminium; Gelenke aus poliertem Aluminium.

Spezifikation

Stehleuchte und Micro-Stehleuchte mit zwei Gelenken, Leseleuchte mit einem Gelenk.

Materiales

Base de acero revestida de aluminio y estructura con brazos móviles de aluminio pulido; difusor orientable en todas direcciones en aluminio anodizado opaco; articulaciones de aluminio pulido.

Especificaciones

Está disponible con dos articulaciones y en dos tamaños (terra y micro terra) y con sólo una articulación (lectura). Sistema de equilibrado a muelles.

Tolomeo micro floor

Tolomeo basculante floor Tolomeo basculante reading floor

Michele De Lucchi
Giancarlo Fassina
2006

Materiali

Base in acciaio rivestita in alluminio, struttura a bracci mobili in alluminio lucidato; snodi in alluminio brillantato, diffusore in carta pergamena o in raso di seta supportato da materiale plastico.

Specificità

Disponibile nella versione floor (con due snodi) o reading floor (con uno snodo). Sistema di equilibratura a molle. Il diffusore, nel normale utilizzo, si dispone verticalmente, indipendentemente dall'angolazione del braccio.

Materials

Aluminium-coated steel base, cantilevered arms in polished aluminium; joints in polished aluminium; diffuser in parchment paper or in silk satin fabric on a plastic frame.

Specification

Available in floor (with two joints) or in reading-floor version (with only one joint). System of spring balancing. The diffuser normally used, remains vertical regardless of the angle of the arm.

Matériaux

Base en acier revêtue d'aluminium, structure à bras articulés en aluminium poli ; articulations en aluminium brillant ; diffuseur en papier parchemin ou en polycarbonate recouvert de satin de soie.

Spécificité

Disponible dans les versions lampadaire (avec deux articulations) et lampadaire de lecture (avec une articulation). Système d'équilibrage à ressorts. Le diffuseur dans le cadre d'une utilisation normale, se place verticalement, indépendamment de la position du bras.

Materialien

Die Stahlbasis ist mit Aluminium beschichtet, Ausrichtbare Arme aus glänzendem Aluminium; Gelenke aus poliertem Aluminium; Schirm aus mit Kunststoff stabilisiertem Pergamentpapier oder Seidensatin.

Spezifikation

Erhältlich als Stehleuchte (mit zwei Gelenken) und als Lese-Version (mit nur einem Gelenk); mit Federausgleichsystem. Der Schirm steht normalerweise vertikal, unabhängig von der Ausrichtung des Armes.

Materiales

Base de acero revestida de aluminio, estructura con brazos móviles de aluminio pulido; articulaciones de aluminio pulido; difusor en pergamino o en raso seda reforzado con plástico.

Especificaciones

Está disponible en versión de pie (con dos articulaciones) y de lectura (con sólo una articulación). Sistema de equilibrado a muelles. En su uso normal, el difusor se dispone verticalmente, independientemente del ángulo del brazo.

Light emission



Colours



Base and structure:
Mirror



Diffuser:
Natural



Diffuser:
Grey



Tolomeo basculante floor

Tolomeo mega

Michele De Lucchi
Giancarlo Fassina
2002



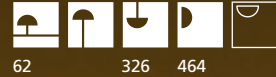

62

326

464

LED

LED

Materiali

Base in alluminio lucidato; struttura a bracci mobili in alluminio lucidato; diffusore in carta pergamena o in raso di seta supportato da materiale plastico; snodi in alluminio brillantato.

Specificità

Diffusore disponibile in tre dimensioni, orientabile in tutte le direzioni. Sistema di equilibratura a molle.

Materials

Polished aluminium base and cantilevered arms; diffuser in parchment paper or in silk satin fabric on a plastic frame; joints in polished aluminium.

Specification

Diffuser, available in three sizes, adjustable in all directions. System of spring balancing.

Matériaux

Base et structure à bras articulés en aluminium poli ; diffuseur en papier parchemin, en polycarbonate ou recouvert de satin de soie gris ou noir ; articulations en aluminium brillant.

Spécificité

Diffuseur disponible en trois tailles, orientable dans toutes les directions. Système d'équilibrage à ressorts.

Materialien

Sockel und ausrichtbare Arme aus glänzendem Aluminium; Schirm aus mit Kunststoff stabilisiertem Pergamentpapier oder Seidensatin; Gelenke aus poliertem Aluminium.

Spezifikation

Der Leuchtenkopf, welcher in drei Größen erhältlich ist, lässt sich in alle Richtungen verstellen. Federausgleichsystem.

Materiales

Pie y estructura con brazos móviles de aluminio pulido; difusor en pergamino o en raso seda reforzado con plástico; articulaciones de aluminio pulido.

Especificaciones

Difusor disponible en tres tamaños, orientable en todas direcciones. Sistema de equilibrado a muelles.

Light emission



Colours



Base and structure:
Mirror



Diffuser:
Natural



Diffuser:
Grey



Base and structure:
Black



Diffuser:
Black

Awards

2003 – Reddot Design Award
Essen (Deutschland)

Tolomeo lampione outdoor Tolomeo paralume outdoor

Michele De Lucchi
Giancarlo Fassina
2016

"La sorgente luminosa LED è racchiusa da una calotta diffondente collocata all'interno di un elemento plastico trasparente che rimanda la memoria ai vecchi lampioni che si usavano quando ancora la luce era ottenuta con il petrolio. La famiglia è anche arricchita da un paralume per adattare il lampione nelle terrazze o negli ambienti esterni con carattere più domestico."
Michele De Lucchi

"The LED lighting source is enclosed in a spherical diffuser fitted inside a clear plastic element that recalls old-time lampposts in use when light was still obtained from oil. The family also includes a lampshade to adapt the lamppost for use on terraces or in outdoor home environments."
Michele De Lucchi

"La source lumineuse LED est enfermée dans une calotte diffusante placée à l'intérieur d'un élément plastique transparent rappelant les anciens réverbères que l'on utilisait lorsque la lumière était encore obtenue à partir du pétrole. Cette famille s'enrichit aussi d'un abat-jour pour adapter le réverbère aux terrasses ou aux espaces extérieurs au caractère plus domestique."
Michele De Lucchi

"Die LED-Lichtquelle ist umschlossen von einer diffusen Haube, die in einem durchsichtigen Kunststoff-Element angeordnet ist, welches an die alten Straßenlaternen erinnert, die verwendet wurden, als mit Öl beleuchtet wurde. Die Serie wird zudem durch einen Lampenschirm erweitert, um die Laterne auf den Terrassen oder im Außenbereich mit einem häuslichen Charakter zu versehen."
Michele De Lucchi

"La fuente luminosa LED está encerrada en un casquete difusor situado dentro de un elemento plástico transparente que recuerda las antiguas farolas que se utilizaban cuando la luz aún se obtenía con el petróleo. La familia se enriquece con una pantalla para adaptar el farol en las terrazas o en los ambientes exteriores con carácter más doméstico."
Michele De Lucchi

Tolomeo lampione outdoor

Light emission



Colours



Base and structure:
Mirror



Diffuser:
Transparent

Awards

Tolomeo lampione
2017 – Wallpaper Design Award
"Best Garden Party"



328

LED





Tolomeo paralume outdoor



Tolomeo lampione outdoor



Materiali

Il diffusore di Tolomeo Paralume è rivestito in tessuto Thua di Paola Lenti, un materiale plastico che, con l'aspetto di una iuta naturale, garantisce resistenza e lavabilità. Materiali e finiture adatte per esterni.

Specificità

Tolomeo Lampione Outdoor è progettata per un utilizzo anche senza diffusore, lasciando in vista l'elemento diffusore opalino di copertura della sorgente che garantisce la protezione IP44: assume così l'aspetto che ricorda i tradizionali lampioni.

Materials

The diffuser of Tolomeo Paralume is coated with Thua fabric by Paola Lenti, a plastic material that looks like natural jute but ensures high resistance and washability. Materials and finishes are fit for outdoor use.

Specification

Tolomeo Lampione Outdoor is designed for use without a diffuser, with the exposed opal glass diffusing unit covering the source and ensuring IP44 protection: in this version it looks like a traditional lamppost.

Matériaux

Le diffuseur de Tolomeo Paralume est revêtu d'un tissu Thua de Paola Lenti, matière plastique qui, ayant l'aspect d'une jute naturelle, garantit résistance et lavabilité. Matières et finitions adaptées à l'extérieur.

Spécificité

Tolomeo Lampione Outdoor est conçu pour être utilisé même sans le paralume, laissant en vue l'élément diffuseur opale qui couvre la source et assure la protection IP44. Cela rappelle les lampadaires traditionnels.

Materialien

Der Diffusor vom Lampenschirm Tolomeo ist von Paola Lenti mit Thua-Stoff ausgekleidet, einem Kunststoff, der wie natürliche Jute aussieht, aber Haltbarkeit und Waschbarkeit gewährleistet. Materialien und Oberflächen sind für den Outdoor-Einsatz geeignet.

Spezifikation

Tolomeo Lampione Outdoor ist so konzipiert, auch ohne den Lautsprecher zu verwenden, einen Blick auf die Quelle der Abdeckung Opal Diffusorelement verlassen, die die Schutzart IP44 gewährleistet. Das hat die Form erinnert an die traditionellen Straßenlampen.

Materiales

El difusor de Tolomeo Pantalla está revestido en tejido Thua de Paola Lenti, un material plástico que, con el aspecto de un yute natural, garantiza resistencia y lavabilidad. Materiales y acabados adecuados para uso en exteriores.

Especificaciones

Tolomeo Lampione Outdoor está diseñado para ser utilizado incluso sin el altavoz, dejando una vista de la fuente de cubierta Opal elemento difusor que asegura la protección IP44: esto toma la forma que recuerda a las lámparas tradicionales de la calle.

Tolomeo paralume outdoor

Light emission



Colours



Base and structure:
Mirror



Diffuser:
White



Diffuser:
Black

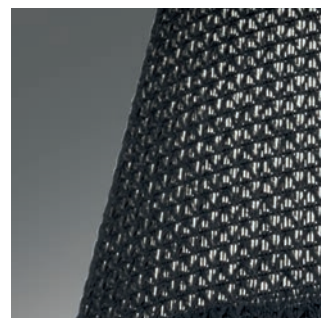



Materiali

Base in cemento; struttura a bracci mobili in alluminio lucidato; testa in tecnopolimero stampato con tecnica rotazionale; diffusore in materiale termoplastico opalino satinato; snodi in alluminio brillantato.

Specificità

In scala 4:1 rispetto al modello da tavolo. Il grado di protezione IP65 la rende idonea all'utilizzo anche in esterno. Disponibile con base o supporto fisso (pivot) realizzati in cemento colorato in massa.

Materials

Base in concrete; cantilevered arms in polished aluminium; rotationally moulded technopolymer head; diffuser in opal thermoplastic material; joints in polished aluminium.

Specification

4:1 scale compared to the table version. The IP65 degree of protection makes it suitable for outdoor installation. Available with base or fixed support (pivot) made of solid coloured concrete.



Matériaux

Base en béton; structure à bras articulés en aluminium poli ; tête en techno-polymère roto-moulé ; diffuseur en matériau thermoplastique opalin ; articulations en aluminium brillant.

Spécificité

A l'échelle 4:1 par rapport au modèle à poser. L'indice de protection IP65 permet l'installation de l'appareil en extérieur. Disponible avec base ou support fixe (pivot) réalisés en béton coloré dans la masse.

Materialien

Sockel aus Beton; ausrichtbare Arme aus glänzendem Aluminium; Leuchtenkopf aus Technopolymer hergestellt im Rotations-spritzgussverfahren; Schirm aus thermoplastischem Material; Gelenke aus poliertem Aluminium.

Spezifikation

Im Maßstab 4:1 im Vergleich zu der Tischleuchte ist diese XXL-Version für den Innen- und Außenbereich verfügbar. Erhältlich mit Bodenplatte aus Beton oder als Bodeneinbauvariante.

Materiales

Base en cemento; estructura y brazos móviles en aluminio brillo; cabezal en tecnopolímero trabajado mediante moldeo rotacional; difusor en material termoplástico opal satinado; nudos en aluminio brillo.

Especificaciones

En escala 4:1 respecto al modelo de sobremesa. El grado de protección IP65 la hace idónea para exteriores. Disponible con base o soporte fijo (rotatorio) realizados en cemento de color.

Light emission



Colours



Lampade a sospensione

Suspension lamps
Suspensions
Pendelleuchten
Suspensiones



212
Chlorophyllia



214
Chlorophyllia 2



216
Ameluna
Ameluna RGB



228
Alphabet of light
circular



254
Space Cloud



256
Scopas



258
Copernico



262
Copernico 500



288
Nur
Nur1618
Nur mini



294
Nur gloss
Nur gloss mini



296
Mercury
Mercury mini



298
Cosmic Angel



320
Tolomeo due bracci
pergamena
suspension



322
Tolomeo decentrata
suspension



326
Tolomeo mega
suspension



328
Tolomeo paralume
suspension
outdoor



344
Castore calice 18



346
Vigo



348
Stablight
Stablight A, B, C



354
Miconos



372
Choose
Choose mega
suspension



374
Eggboard



378
Silent field



382
Nur acoustic



228
Alphabet of light
linear



234
Discovery

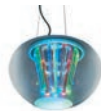

238
Spectral light



242
Orsa 21, 35



244
Orsa chandelier 3
Orsa chandelier 5



246
Unterlinden



250
Pirce
Pirce mini



250
Pirce micro



266
Led Net line
suspension



270
Led Net circle
suspension



272
Fiamma suspension



274
Fiamma 30
suspension



276
Null Vector



278
Altrove LED
suspension



282
Altrove 600 LED
suspension



284
Tian Xia 500 LED



300
Eclittica 50



304
Eclittica 20



306
Decomposé light
suspension



308
Miyako
Miyako chandelier



312
Float circolare



314
Talo suspension



316
Cabildo LED



318
Tolomeo due bracci
alluminio
suspension



328
Tolomeo lampione
suspension
outdoor



328
Tolomeo paralume
hook outdoor



328
Tolomeo lampione
hook outdoor



332
Incalmo
Incalmo 214



336
Invero
Invero 214



338
Empatia
suspension



340
Meteorite
suspension



342
Castore
suspension



356
Logico
Logico mini



356
Logico 3x120°
Logico 3 in linea



360
Empirico
Empirico System



362
Calenda



364
Nuboli



366
Mouette
simmetrica
asimmetrica



368
Lana



370
Edge



384
Les Danseuses

"Un'installazione di elementi naturali ottici pensati come una fusione tra natura e geometrie artificiali. La luce diventa interazione attraverso la proiezione sul soffitto, che crea uno spazio etereo, delicato e femminile." Ross Lovegrove

Materiali

Corpo luminoso in alluminio pressofuso, struttura centrale in tecnopolimero, elementi a foglie in metacrilato trasparente stampato ad iniezione.

Specificità

Il corpo centrale sospeso emette una luce indiretta che viene filtrata e rifratta dalle superfici trasparenti che con la loro forma ricordano degli elementi naturali, delle foglie.

"An installation of natural optical elements conceived as a blend of natural and artificial geometries. Light becomes an interaction through projection on the ceiling, designing an ethereal, soft, feminine space." Ross Lovegrove.

Materials

Die-cast aluminium lighting body, technopolymer frame, clear leaf-shaped injection-moulded engineering methacrylate elements.

Specification

The main suspended body produces indirect light that is filtered and refracted by clear surfaces, whose shape recalls natural elements, leaves.

"Une installation d'éléments optiques naturels conçus comme une fusion entre la nature et les géométries artificielles. La lumière devient interaction par sa projection sur le plafond qui crée un espace éthéré, délicat et féminin". Ross Lovegrove

Matériaux

Corps lumineux en aluminium moulé sous pression, structure centrale en techno-polymère, éléments en forme de feuilles en méthacrylate transparent moulé par injection.

Spécificités

Le corps central suspendu émet une lumière indirecte filtrée et réfractée par les surfaces transparentes qui, par leur forme, rappellent des éléments naturels, des feuilles.

"Eine Installation an natürlichen Leuchtelementen, die als Verschmelzung zwischen Natur und künstlichen Geometrien entworfen sind. Das Licht wird durch die Projektion an der Decke zur Interaktion, die einen ätherischen, zarten und femininen Raum erzeugt." Ross Lovegrove

Materialien

Leuchtkörper aus Aluminiumguss, zentrale Struktur aus Technopolymer, Blatt-Elemente aus transparentem, spritzgegossenem Methacrylat.

Spezifikation

Der zentrale, hängende Körper emittiert indirektes Licht, das von transparenten Oberflächen filtriert und gebrochen wird, die mit ihrer Form an natürliche Elemente erinnern: an Blätter.

"Una instalación de elementos naturales ópticos pensados como una fusión entre naturaleza y geometrías artificiales. La luz se vuelve interacción a través de la proyección en el techo, que crea un espacio etéreo, delicado y femenino." Ross Lovegrove

Materiales

Cuerpo luminoso de aluminio fundido a presión, estructura central en tecnopolímero, elementos de hojas de metacrilato transparente moldeado por inyección.

Especificaciones

El cuerpo central suspendido emite una luz indirecta que es filtrada y refractada por las superficies transparentes que con su forma recuerdan los elementos naturales, unas hojas.

Light emission



Colours





LED

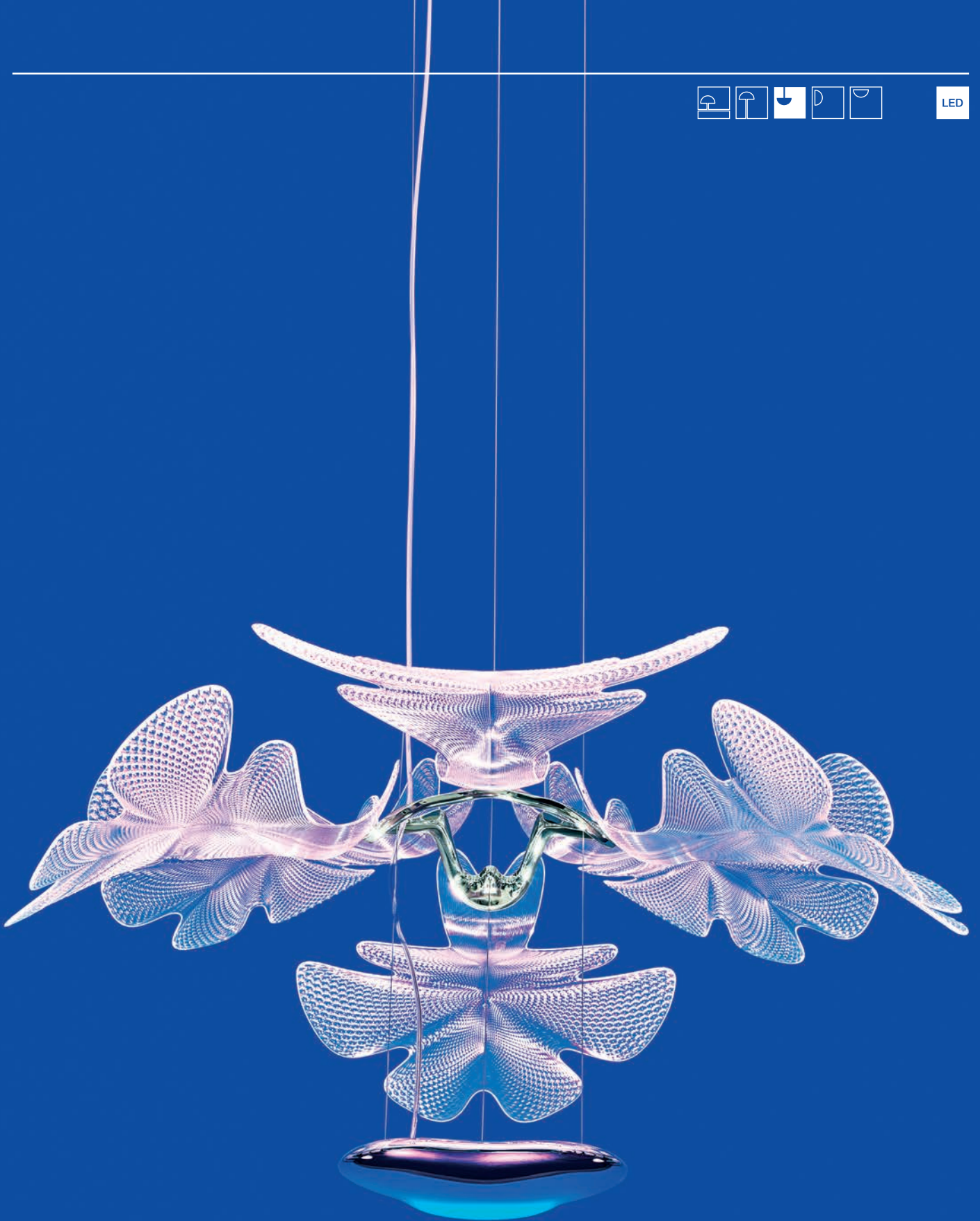

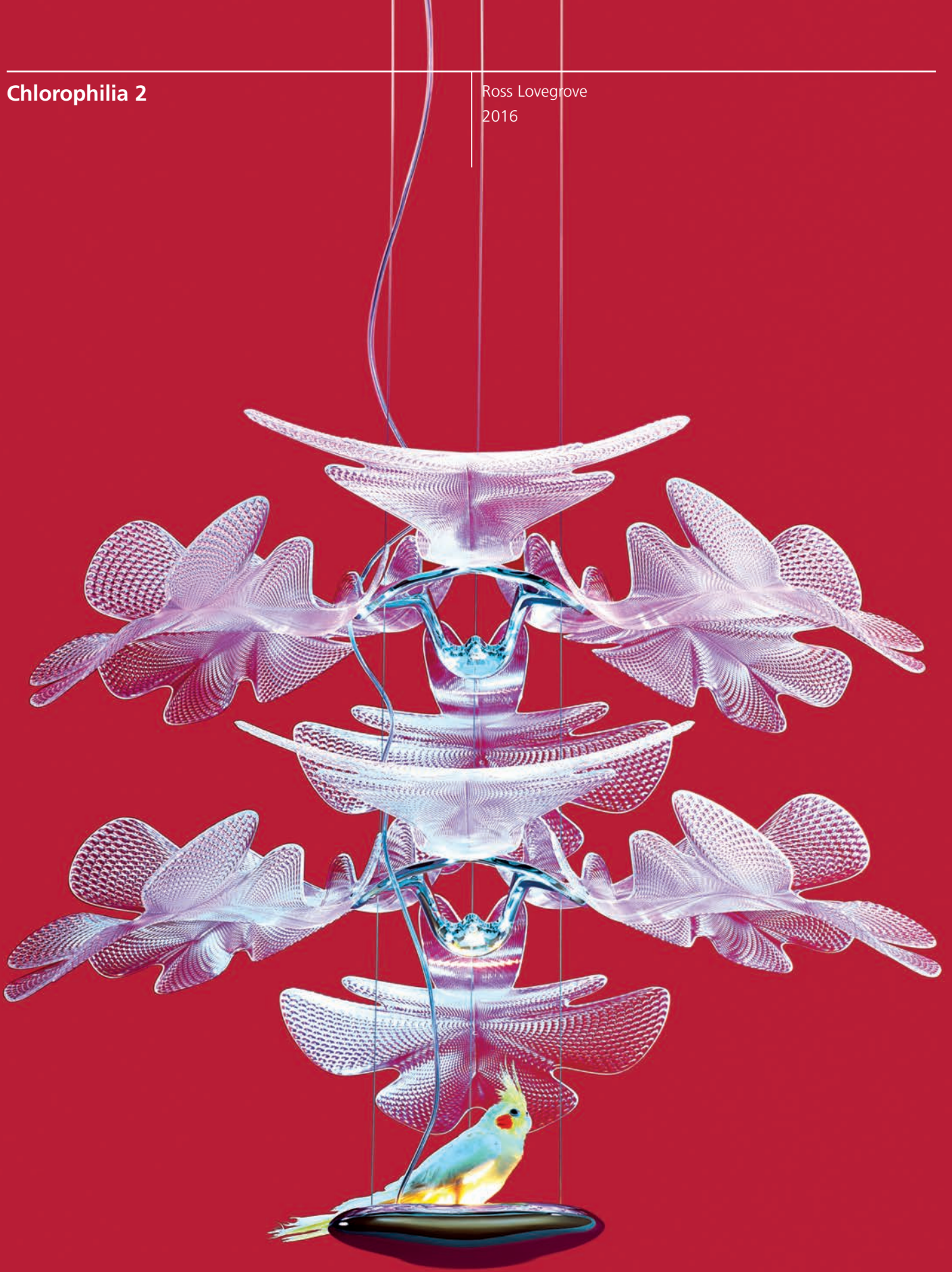



LED

Materiali

Corpo luminoso in alluminio pressofuso, struttura centrale in tecnopolimero, elementi a foglie in metacrilato trasparente stampato ad iniezione.

Specificità

Il corpo centrale sospeso emette una luce indiretta che viene filtrata e rifratta dalle superfici trasparenti che con la loro forma ricordano degli elementi naturali, delle foglie. Chlorophilia 2 duplica le superfici trasparenti su due livelli rendendo ancora più scenografica la presenza della lampada.

Materials

Die-cast aluminium lighting body, technopolymer frame, clear leaf-shaped injection-moulded engineering methacrylate elements.

Specification

The main suspended body produces indirect light that is filtered and refracted by clear surfaces, whose shape recalls natural elements, leaves. Chlorophilia 2 duplicates the clear surfaces on two levels for a more dramatic look.

Matériaux

Corps lumineux en aluminium moulé sous pression, structure centrale en techno-polymère, éléments en forme de feuilles en méthacrylate transparent moulé par injection.

Spécificités

Le corps central suspendu émet une lumière indirecte filtrée et réfractée par les surfaces transparentes qui, par leur forme, rappellent des éléments naturels, des feuilles. Chlorophilia 2 double les surfaces transparentes sur deux niveaux, rendant la présence de la lampe encore plus scénographique.

Materialien

Leuchtkörper aus Aluminiumguss, zentrale Struktur aus Technopolymer, Blatt-Elemente aus transparentem, spritzgegossenem Methacrylat.

Spezifikation

Der zentrale, hängende Körper emittiert indirektes Licht, das von transparenten Oberflächen filtriert und gebrochen wird, die mit ihrer Form an natürliche Elemente erinnern: an Blätter. Chlorophilia 2 dupliziert die transparenten Flächen auf zwei Ebenen und macht die Präsenz der Leuchte noch eindrucksvoller.

Materiales

Cuerpo luminoso de aluminio fundido a presión, estructura central en tecnopolímero, elementos de hojas de metacrilato transparente moldeado por inyección.

Especificaciones

El cuerpo central suspendido emite una luz indirecta que es filtrada y refractada por las superficies transparentes que con su forma recuerdan los elementos naturales, unas hojas. Chlorophilia 2 duplica las superficies transparentes en dos niveles haciendo aún más escenográfica la presencia de la lámpara.

Light emission



Colours



Transparent



Mercedes-Benz Style

Ameluna combina bellezza e intelligenza attraverso una forma totalmente trasparente che si fonde con una luce dinamica per creare infiniti scenari. È un'interazione tra forme pure e un sensuale volume asimmetrico che crea una tensione dinamica ed altamente emotiva. Ameluna rivela una rivoluzionaria optoelettronica integrata nel corpo trasparente.

Ameluna discloses an innovative optoelectronic system integrated in the transparent frame. An aluminium band, a patent of innovation, which is welded with the optics, supports the led strip. The latter is also hidden behind the lower profile, in order to maintain the purity of the form. The transparent body allows the light to be both direct and partially refracted.

Ameluna associe la beauté et l'intelligence par une forme totalement transparente qui se fond avec une lumière dynamique pour créer des scénarios infinis. C'est une interaction entre formes pures et un volume asymétrique sensuel qui crée une tension dynamique et hautement émotive. Ameluna révèle une optoélectronique révolutionnaire intégrée dans le corps transparent.

Ameluna verbindet Schönheit mit Intelligenz durch eine vollständig transparente Form, die sich mit einem dynamischen Licht vereint, um endlose Szenarien zu erstellen. Es ist ein Zusammenspiel zwischen klaren Linien und einem asymmetrischen, sinnlichen Volumen, welches eine dynamische und sehr emotionale Spannung erzeugt. Ameluna enthüllt eine revolutionäre Optoelektronik, welche im transparenten Leuchtenkörper integriert ist.

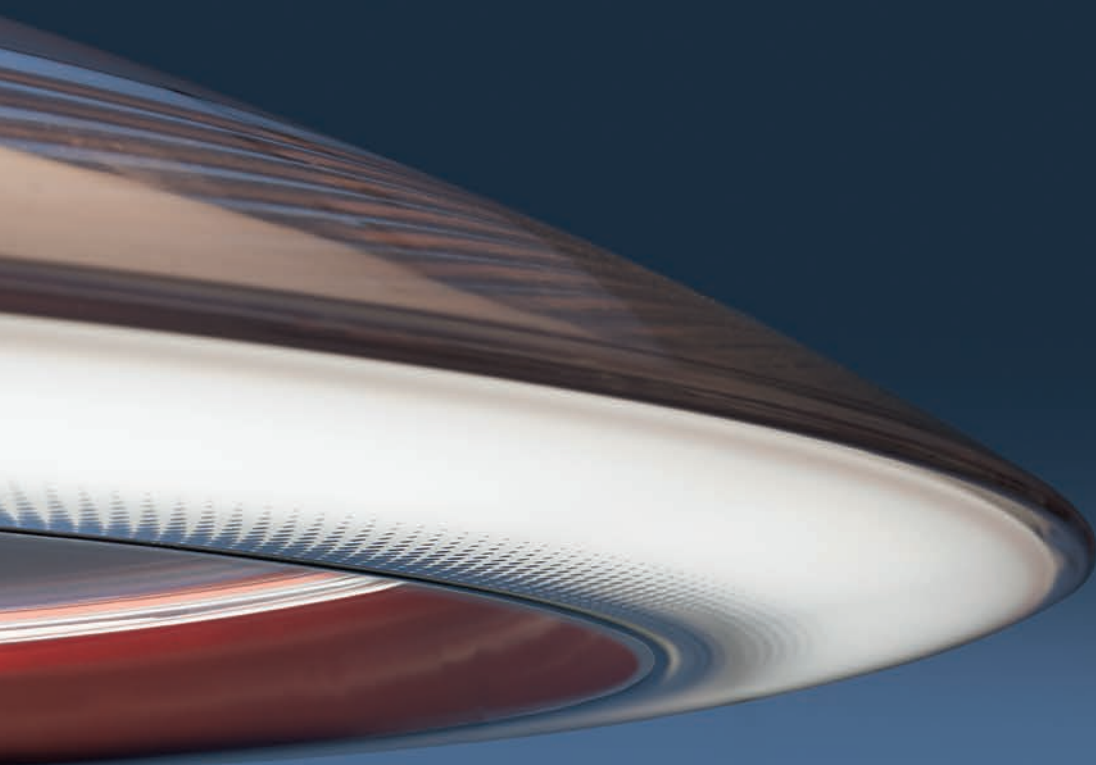

Ameluna combina belleza e inteligencia a través de una forma totalmente transparente que se funde con una luz dinámica para crear un sinfín de escenarios. Es una interacción entre formas puras y un volumen asimétrico sensual que crea una tensión dinámica y muy emotiva. Ameluna revela una revolucionaria optoelectrónica integrada en el cuerpo transparente.

Awards

2017 – Reddot Design Award
“Best of the Best”, Essen (Deutschland)
2017 - IF Product Design Award

Ameluna

Light emission



Colours



Ameluna RGB

Light emission



Colours

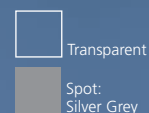

“Mercedes-Benz” and the styling of Ameluna are intellectual property of Daimler AG. They are used by Artemide S.p.A under license.



Ameluna RGB

"La sospensione Ameluna esprime perfettamente la filosofia Mercedes-Benz di sensual purity. Come le nostre auto è una perfetta combinazione di emozione e intelligenza."

Gorden Wagener, Vice President Design Daimler AG

Attraverso uno spot RGB LED possono essere create infinite atmosfere cromatiche.

Materiali

Calotta in metacrilato trasparente stampato ad iniezione; anello dissipante in tecnopolimero termoconduttivo con finitura verniciata. Diffusore in metacrilato diffondente con serigrafia esterna. Anello interno con funzione di diffusore/riflettore in tecnopolimero ad altissima efficienza.

"The pendant lamp Ameluna stages our Mercedes-Benz design philosophy of sensual purity perfectly. Just like our vehicles, it is a perfect combination of emotion and intelligence."

Gorden Wagener, Vice President Design Daimler AG

A countless number of chromatic atmospheres can be created with the use of an innovative RGBW spot.

Materials

Transparent methacrylate injection molded shell; dissipating ring in thermo-conductive technopolymer with a painted finish. Methacrylate diffuser with external screen printing. Inner ring with diffuser/reflector function in technopolymer with a very high efficiency.

"La suspension Ameluna exprime parfaitement la philosophie Mercedes-Benz de la 'sensual purity'. Comme nos voitures, c'est une association parfaite entre l'émotion et l'intelligence."

Gorden Wagener, Vice-Président Design Daimler AG

Par un spot RGB LED on peut créer une infinité d'atmosphères chromatiques.

Matériaux

Coque transparente moulée en méthacrylate injecté ; anneau dissipateur en techno-polymère thermo-conducteur avec finition peinte. Diffuseur en méthacrylate avec sérigraphie externe. Bague intérieure avec fonction diffuseur/réfecteur en techno-polymère avec un rendement très élevé.

"Die Pendelleuchte Ameluna drückt perfekt die Philosophie von Mercedes-Benz zu Sensual Purity aus. Wie unsere Autos besteht sie aus der perfekten Kombination aus Emotion und Intelligenz."

Gorden Wagener, Vice President Design Daimler AG

Mit einem Spotlight RGB LED können endlose Farbatmosphären erzeugt werden.

Materialien

Körper aus transparentem Methacrylat-Spritzguss; Dissipationsring in thermoleitfähigem Technopolymer mit lackiertem Finish. Methacrylat-Diffusor mit Siebdruck. Innenring mit Diffusor-/ Reflektorfunktion in Technopolymer mit sehr hohem Wirkungsgrad

"La suspensión Ameluna expresa perfectamente la filosofía Mercedes-Benz de sensual purity. Como nuestros coches, es una combinación perfecta de emoción e inteligencia."

Gorden Wagener, Vice President Design Daimler AG

A través de un spot RGB LED se pueden crear un sinfín atmósferas cromáticas.

Materiales

Cubierta moldeada a inyección de metacrilato transparente; anillo disipador en tecnopolímero termoconductor con acabado pintado. Difusor de metacrilato con serigrafía externa. Anillo interior con función de difusor/reflector en tecnopolímero de muy alta eficiencia.

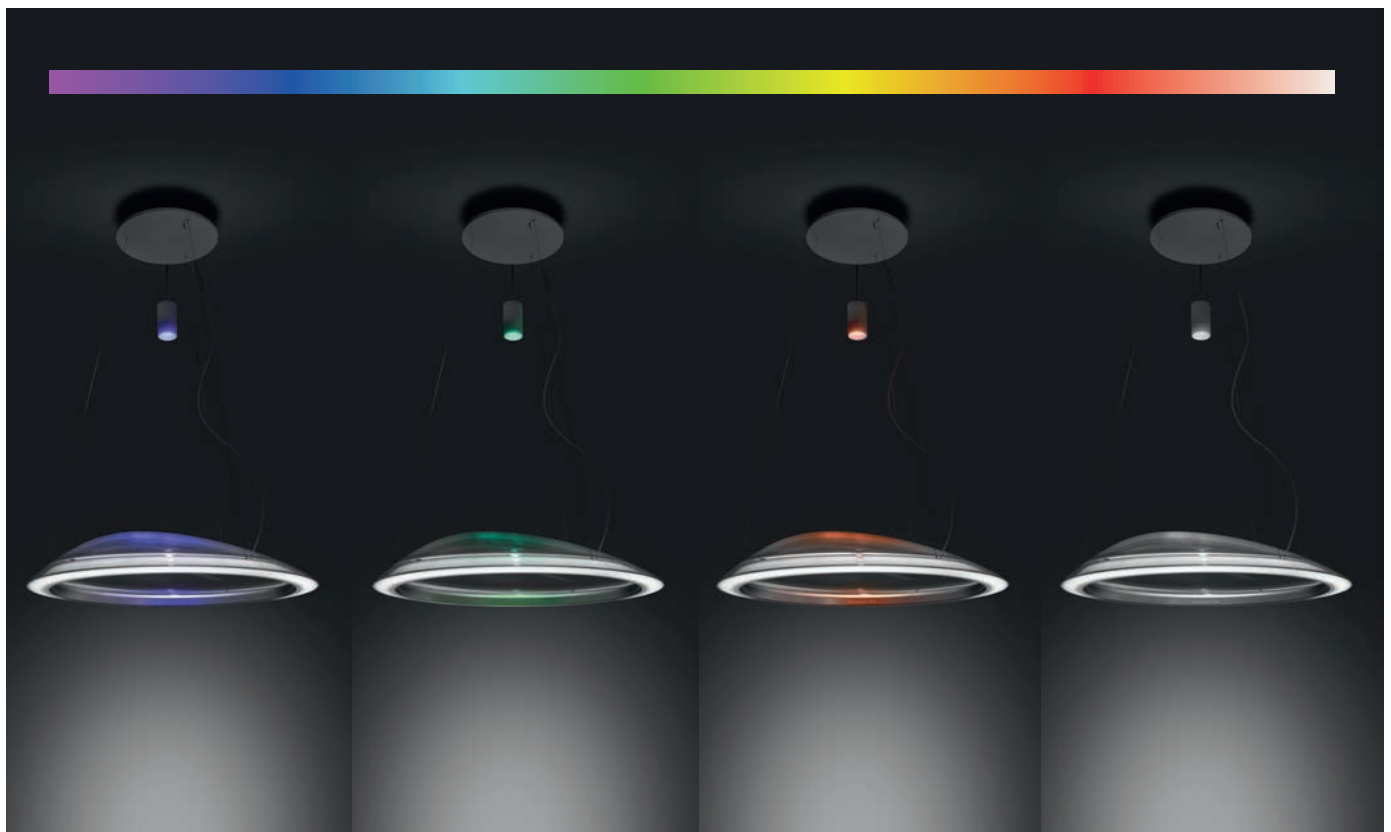



Ameluna RGB



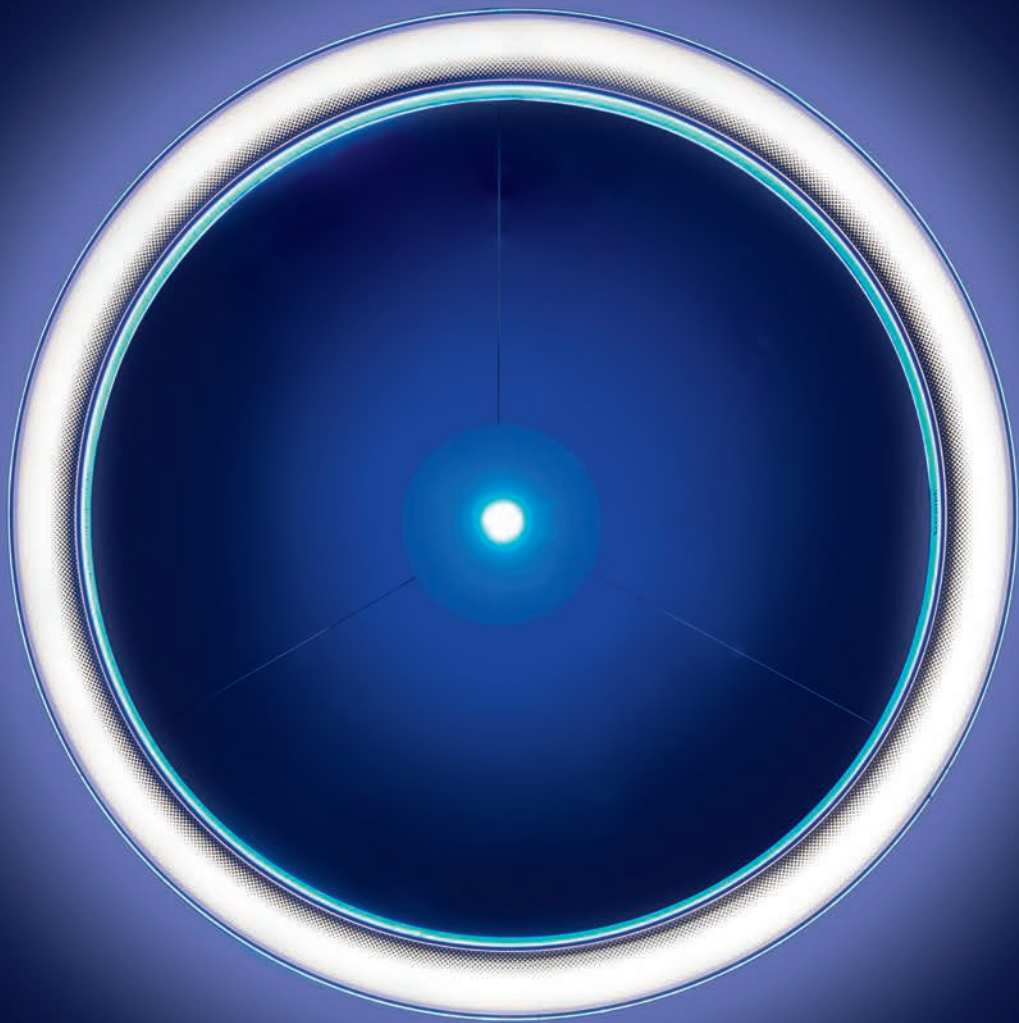

Ameluna RGB bottom view

Attraverso la geometria della sezione e le caratteristiche ottiche dei materiali si ottiene una "light box" che determina un perfetto controllo dell'emissione pur nella trasparenza. Una serie di sorgenti LED sono installate lungo il profilo inferiore su un anello realizzato in tecnopolimero termoconduttivo, un innovativo materiale che consente un'ottima dissipazione termica. L'emissione è perfettamente progettata attraverso l'attenta selezione dei materiali che costituiscono la "light box". Le particolari proprietà di riflettanza e trasmittanza unite ad un bassissimo coefficiente di assorbimento fanno sì che la luce riflessa dalle superfici interne del vano ottico sia distribuita nell'ambiente in modo controllato e principalmente diretto.

The geometric section and the optical features of the materials give life to a "light box" that ensures perfect control of the emission, despite transparency. A set of LED sources is installed along the lower profile, on a ring made of a thermo-conductive polymer, an innovative material that allows excellent heat dissipation. Emission is perfectly designed through careful selection of the materials constituting the "light box". The special reflectance and transmittance properties, combined with a very low absorption coefficient, ensure that the light reflected from the inner surfaces of the section is scattered across the environment in a controlled and mostly direct way.

Par la géométrie de la section et les caractéristiques optiques des matières on obtient une "light box" qui détermine un contrôle parfait de l'émission ainsi que de la transparence. Une série de sources LED sont installées le long du profil inférieur sur un anneau réalisé en tecnopolymère thermoconducteur, une matière innovante qui permet une excellente dissipation thermique. L'émission est parfaitement conçue par la sélection attentive des matières qui constituent la "light box". Les propriétés particulières de réflectance et transmittance, associées à un coefficient d'absorption très bas, font en sorte que la lumière reflétée par les surfaces intérieures du creux optique est distribuée dans l'espace de manière contrôlée et principalement directe.

Durch die Geometrie der Einteilung und die Leuchteigenschaften des Materials entsteht eine "Light Box", die selbst bei der Transparenz die perfekte Kontrolle über die Lichtemission hat. Eine Serie an LED-Lichtquellen befindet sich am unteren Profil auf einem Ring aus leitfähigem Technopolymer, einem innovativen Material, das eine ausgezeichnete Wärmeableitung ermöglicht. Die Lichtemission wird durch die sorgfältige Auswahl der Materialien der "Light Box" perfekt. Die besonderen Eigenschaften von Reflexion und Transmission, kombiniert mit einem sehr geringen Absorptionskoeffizienten ermöglichen, dass das Licht von den inneren Flächen des Leuchtegehäuses kontrolliert und im Wesentlichen gerade im Ambiente verteilt wird.

A través de la geometría de la sección y las características ópticas de los materiales se obtiene una "light box" que determina un control perfecto de la emisión incluso en la transparencia. Una serie de fuentes LED están instaladas a lo largo del perfil inferior en un anillo realizado de tecnopolímero termoconductor, un material innovador que permite una disipación térmica excelente. La emisión está perfectamente diseñada a través de una selección cuidadosa de los materiales que constituyen la "light box". Las propiedades de reflectancia y transmitancia particulares combinadas con un muy bajo coeficiente de absorción hacen que la luz reflejada por las superficies interiores del compartimiento óptico esté distribuida en el ambiente de forma controlada y principalmente directa.

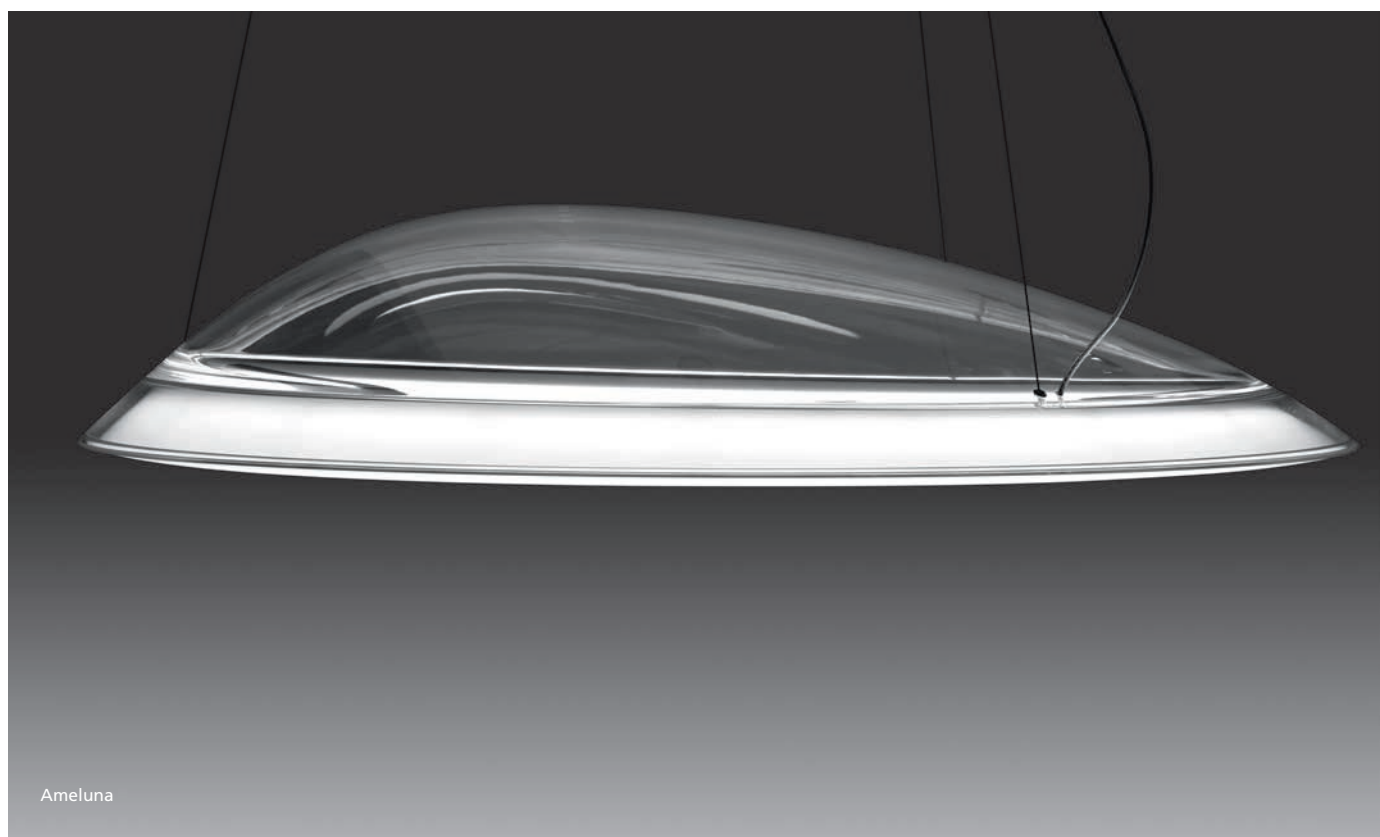

L'intelligenza di Ameluna RGB si esprime infatti non solo nell'innovazione optoelettronica ma anche nell'interazione IoT. La luce di ogni interno, in auto o in uno spazio, può essere parte di Internet of Things e seguire con il variare degli scenari la nostra percezione ed esperienza. È una nuova frontiera di progetto dove la luce genera emozione e interazione. Ameluna App consente di vivere in modo totalmente nuovo il rapporto con la luce attraverso un'esperienza sorprendente, semplice ed intuitiva. Grazie ad un protocollo mesh BLE dotato di alti standard di sicurezza ci si può connettere ad Ameluna attraverso i vari mobile devices e creare, cambiare e richiamare varie scenografie di luce a seconda di ogni occasione scegliendo l'intensità luminosa della luce bianca e il colore.

The high-tech competence of Ameluna RGB, is conveyed both by optoelectronic innovation and by the IoT interaction. Light in every interior, be it a car or a personal or public space, can be part of the Internet of Things and follow human perception and experience as scenarios change. A new design frontier where light creates both experience and interaction.

The Ameluna App enables an utterly new experience with light through a surprising, simple, and intuitive approach. A BLE mesh protocol based on high safety standards allows to connect with Ameluna using a variety of mobile devices, as well as to create, change, or set up different lighting scenarios matching every occasion and to choose the intensity of white light and colour.

En effet, la supériorité d'Ameluna RGB s'exprime non seulement par l'innovation optoélectronique mais aussi par l'interaction IoT. La lumière de chaque intérieur, en voiture ou dans un espace, peut faire partie d'Internet of Things et suivre notre perception et notre expérience en variant les scénarios. C'est une nouvelle frontière de projet où la lumière crée émotion et interaction. Ameluna App permet de vivre d'une manière tout à fait nouvelle le rapport avec la lumière par une expérience surprenante, simple et intuitive. Grâce à un protocole mesh BLE équipé de hauts standards de sécurité, on peut se connecter à Ameluna par les différents dispositifs mobiles et créer, changer et rappeler différentes scénographies de lumière selon chaque occasion et en choisissant l'intensité lumineuse de la lumière blanche et la couleur.

Die Intelligenz von Ameluna RGB äußert sich nicht nur in der optoelektronischen Innovation, sondern auch in der IoT-Interaktion. Das Licht von jeder Inneneinrichtung im Auto und in einem Ambiente kann Teil des Internet of Things sein und kann mit dem Ändern der Szenarien unserer Wahrnehmung und Erfahrung folgen. Eine neue Projektgrenze, in der das Licht Emotionen und Interaktionen erzeugt. Die Ameluna-App ermöglicht es, durch eine bezaubernde, einfache und intuitive Erfahrung eine ganz neue Art an Beziehung mit dem Licht zu erleben. Aufgrund von einem BLE-Mesh-Protokoll mit hohen Sicherheitsstandards kann sich über verschiedene mobile Geräte mit Ameluna verbunden werden, um entsprechend jeder Situation verschiedene Lichtszenarien zu erstellen, ändern und abzurufen, indem die Intensität des weißen und farbigen Lichts gewählt wird.

La inteligencia de Ameluna RGB, de hecho, se expresa no solo en la innovación optoelectrónica sino también en la interacción IoT. La luz de cada interior, en un coche o en un espacio, puede formar parte del Internet of Things y seguir, con el variar de los escenarios, nuestra percepción y experiencia. Es una nueva frontera de proyecto donde la luz genera emoción e interacción. Ameluna App permite vivir de una manera totalmente nueva la relación con la luz a través de una experiencia sorprendente, sencilla e intuitiva. Gracias a un protocolo mesh BLE con altos estándares de seguridad, es posible conectarse a Ameluna a través de diferentes dispositivos móviles y crear, cambiar y evocar una serie de escenografías de luz dependiendo de la ocasión, eligiendo la intensidad luminosa de la luz blanca y el color.



Network creation



Light control



Scenario control

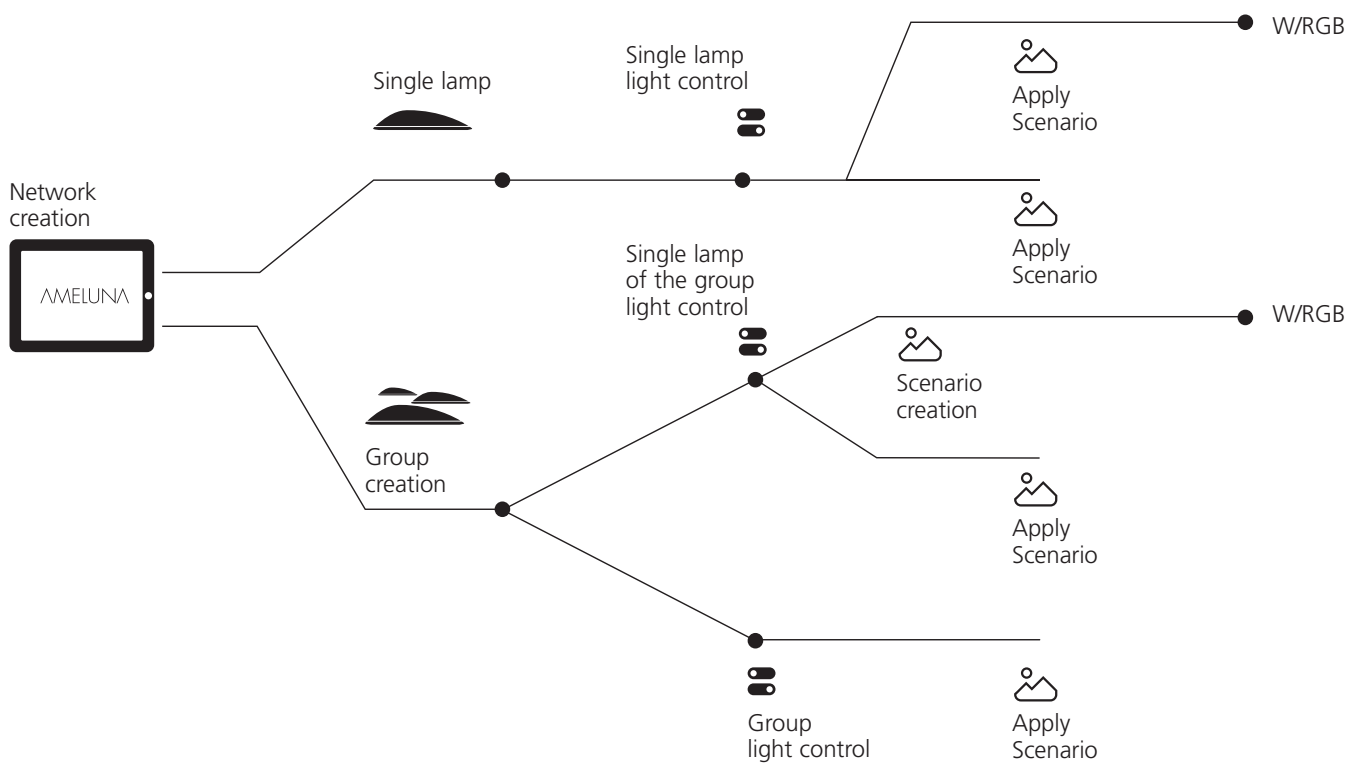

Network creation and modification

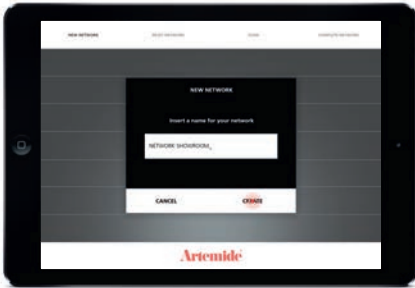

Network naming

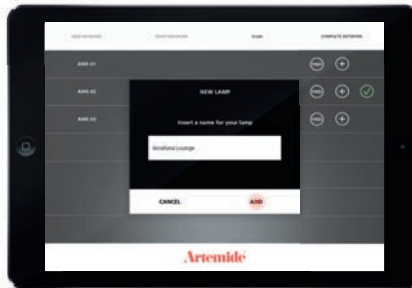

Lamp naming



Password creation



Tap on the "Bin" Logo to remove a lamp(s) from the network



Auto Scanning phase

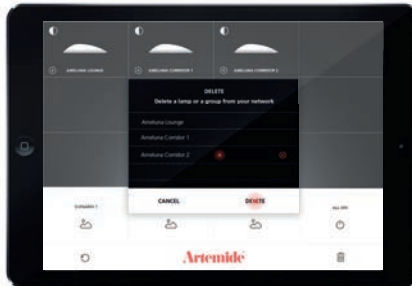

Choose the lamp(s) you want to remove from the network

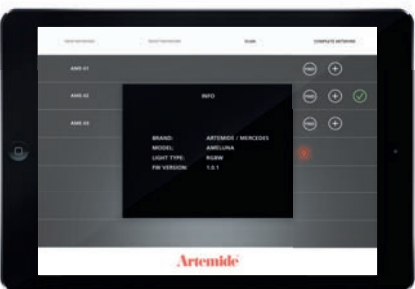

Find physical lamp phase
The lamp will signal itself by blinking



The lamp has been removed from the Network. Tap on the circle arrow to go back to the network screen and scan the area again.

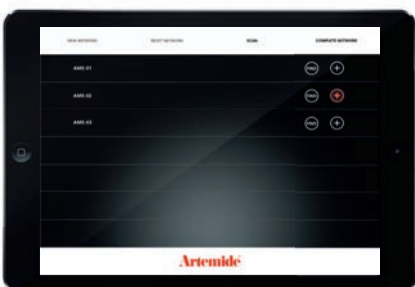

Assigning a lamp to the network

Group creation and modification



Complete network screen

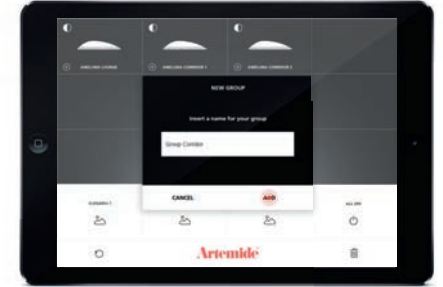

Create a new group pop up (triggered by tapping on the "+" next to the Ameluna icon).



Complete new group lamps association

Light control



Choose the group or lamp to control

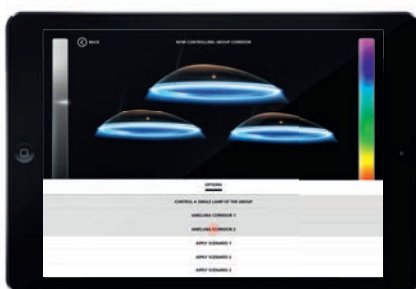

Choose the single lamp of the group to control

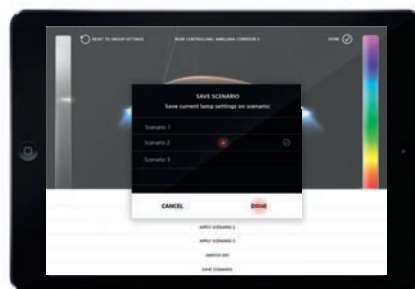

Choose the scenario to overwrite with the new settings



Control the white and rgb emission by using the lateral bars on the screen



Control the emission by using the lateral bars on the screen, confirm settings and turn back complete network screen tapping "DONE"

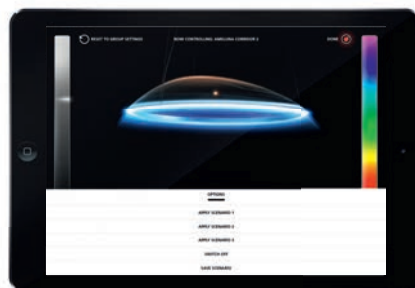

Exit the single lamp settings by tapping on "DONE"



Trigger the Options Menu



Trigger the Options Menu to apply existing scenarios or save a new one with the configurations just set

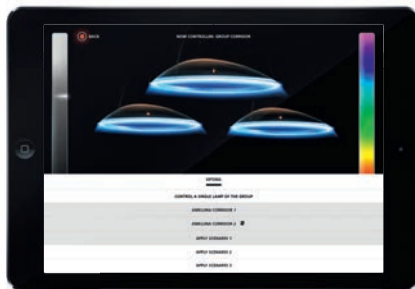

The single lamp within the group is now saved with different settings. Tap "Back" to go to the Network screen



Tap the "Control a single lamp of the Group" to create a different setting on a single lamp of the group



Saving a scenario with the settings applied on the single lamp

Alphabet of light circular
Alphabet of light linear

BIG
2016



Light emission



Colour



White

Awards

2017 – Reddot Design Award
"Best of the Best", Essen (Deutschland)
2016 – Interior Design Magazine Award
Best of year



Photo by Pierpaolo Ferrari, 2017

Patent Pending
MI102016000025996



LED

392

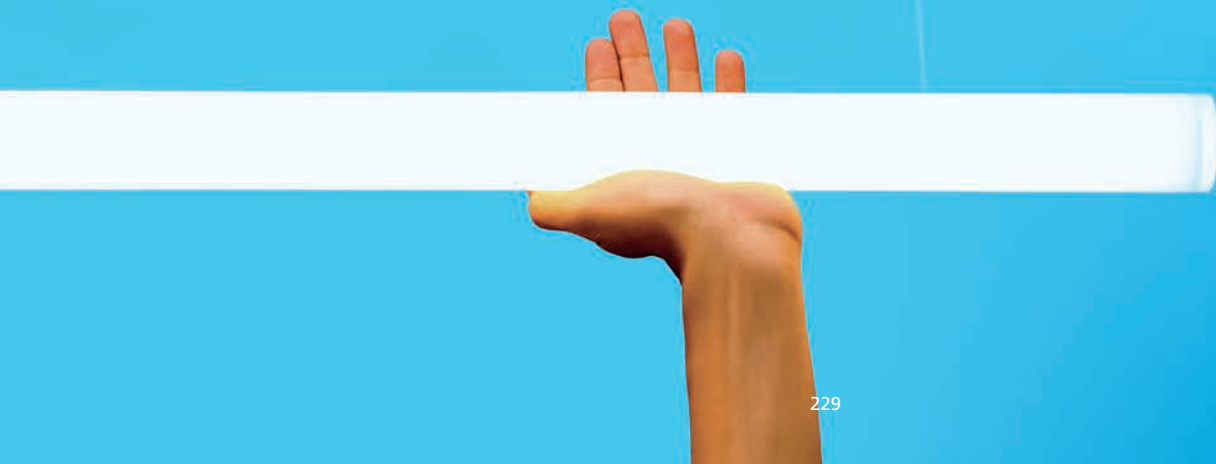

A partire da un abaco di essenziali elementi geometrici BIG disegna un nuovo font che si traduce in luce. Moduli base, lineari o curvi, dalle precise proporzioni geometriche permettono di combinare gli elementi costruendo infinite strutture di luce, essenziali o più complesse. È un principio elementare che genera un sistema aperto. Questa idea si combina alla competenza optoelettronica di Artemide per definire un principio costruttivo innovativo e restituire una luce continua e confortevole.

Materiali

Metacrilato diffondente stampato ad iniezione.

BIG starts from an abacus of essential geometries to design a new font that translates into light. Base modules, either linear or curved, with precise geometric proportions, allow to combine the individual elements to create countless lighting structures, both essential and complex. It is a basic principle that generates an open system. This idea is associated with the optoelectronic skills of Artemide to define an innovative construction principle and produce continuous and comfortable light.

Materials

Injection moulded diffused methacrylate.

A partir d'un abaque d'éléments géométriques essentiels, BIG trace un nouveau caractère qui se traduit par la lumière. Des modules de base, linéaires ou courbes, aux proportions géométriques précises, permettent d'associer les éléments en construisant des structures de lumière infinies, essentielles ou plus complexes. C'est un principe élémentaire qui engendre un système ouvert. Cette idée s'associe à la compétence optoélectronique d'Artemide pour définir un principe constructif innovant et restituer une lumière continue et confortable.

Matériaux

Méthacrylate diffusant moulé.

Ausgehend bei einem Abakus geometrischer Grundelemente zeichnet BIG ein neues Font, das sich in Licht übersetzt. Dieses Konzept verbindet sich mit der optoelektronischen Kompetenz von Artemide, ein innovatives Konstruktionsprinzip zu definieren und ein kontinuierliches und behagliches Licht wiederzugeben. Die Kombination der Geometrie zum Abschnitt und die Leuchteigenschaften der Materialien erzeugen eine diffuse und gleichmäßige Lichtemission ohne Schatten und Blendung von zugleich hoher Leistung.

Materialien

Spritz Gegossen Diffundieren Methacrylat.

A partir de un ábaco de elementos geométricos esenciales, BIG diseña una fuente nueva que se traduce en luz. Esta idea se combina con la competencia optoelectrónica de Artemide para definir un principio de construcción innovador y aportar una luz continua y confortable. La combinación de la geometría de la sección con las propiedades ópticas de los materiales crea una emisión difusa y uniforme sin sombras y deslumbramiento garantizando, al mismo tiempo, un alto rendimiento.

Materiales

Metacrilato difusor estampado a inyeccion.

Alphabet of light circular
Diameter 1550 mm
8 Modules

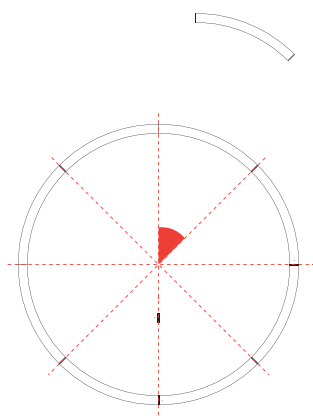

Alphabet of light circular
Diameter 900 mm
6 Modules

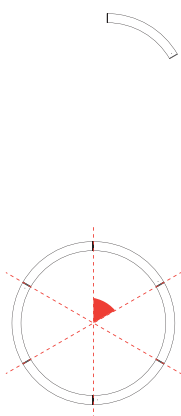

Alphabet of light linear
Length 1200 mm
Stand Alone and System



Alphabet of light linear
Length 1800 mm
Stand Alone and System







Alphabet of light circular



Alphabet of light linear

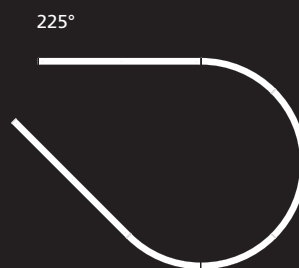
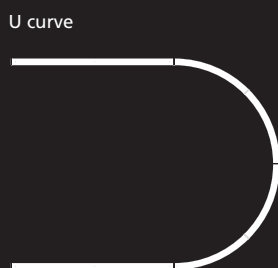
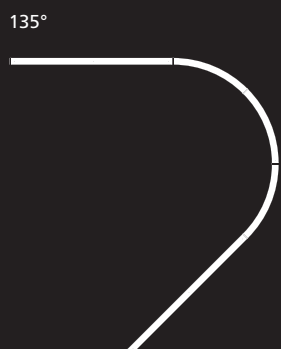
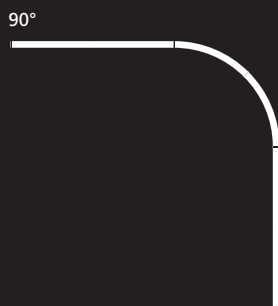
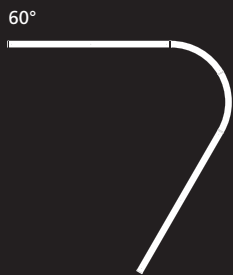
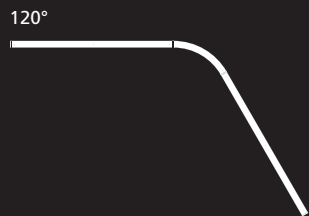

Example 1
closed composition

- 6 linear modules 1200 mm
- 8 round modules 45°-d 1550 mm

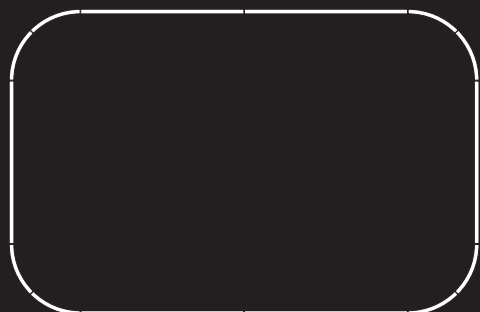

Example 2
free composition

- 7 linear modules 1200 mm
- 2 linear modules 1800 mm
- 10 round modules 45°-d 1550 mm
- 3 round modules 60°-d 900 mm

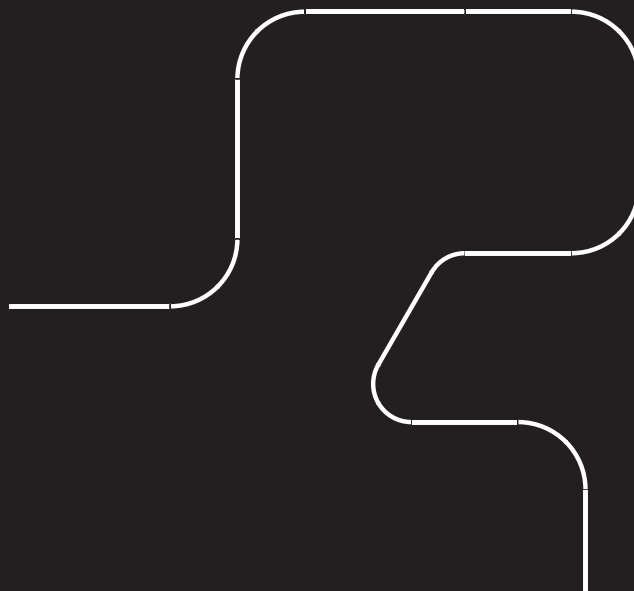

Materiali

Struttura in alluminio, diffusore in tecnopolimero.

Specificità

Un profilo leggerissimo circolare in alluminio è sede di una strip LED che inietta la luce in una superficie plastica trasparente di nuova concezione. L'interno appare da trasparente a pieno di luce, l'assenza si trasforma in una superficie emittente perfettamente diffondente. La luce è avvolgente e uniforme grazie ad un'emissione diretta ed indiretta.

Materials

Aluminium frame, technopolymer diffuser.

Specification

An ultra-light aluminium profile hosts to a LED strip that injects light into a clear plastic surface based on a new concept. The look of the inside ranges from clear to full of light, absence is transformed into an emitting surface that ensures perfect diffusion. Light is all-encompassing and uniform as a result of direct and indirect emission.

Matériaux

Structure en aluminium, diffuseur en techno-polymère.

Spécificités

Un profil circulaire très léger en aluminium est le siège d'un strip LED qui injecte la lumière dans une surface plastique transparente nouvellement conçue. L'intérieur apparaît de transparent à plein de lumière, l'absence se transforme en une surface émettrice parfaitement diffusante. La lumière est enveloppante et uniforme grâce à une émission directe et indirecte.

Materialien

Aluminiumstruktur, Diffusor aus Technopolymer.

Spezifikation

Ein sehr leichtes, kreisförmiges Aluminiumprofil ist der Sitz einer LED-Lichtleiste, die das Licht auf eine durchsichtige Kunststofffläche wirft. Das Leuchteninnere erscheint von transparent zum vollen Licht, die Abwesenheit wird zu einer perfekt diffundierenden Emissionsfläche. Das Licht ist aufgrund einer direkten und indirekten Emission umhüllend und gleichmäßig.

Materiales

Estructura de aluminio, difusor de tecnopolímero.

Especificaciones

Un perfil circular de aluminio muy ligero es sede de una tira LED que inyecta la luz en una superficie plástica transparente de nueva concepción. El interior aparece de transparente a lleno de luz, la ausencia se convierte en una superficie emisora perfectamente difusora. La luz es envolvente y uniforme gracias a una emisión directa e indirecta.

Awards

2017 - Reddot Design Award:
Essen (Deutschland)

Light emission



Colours



Transparent



LED

400

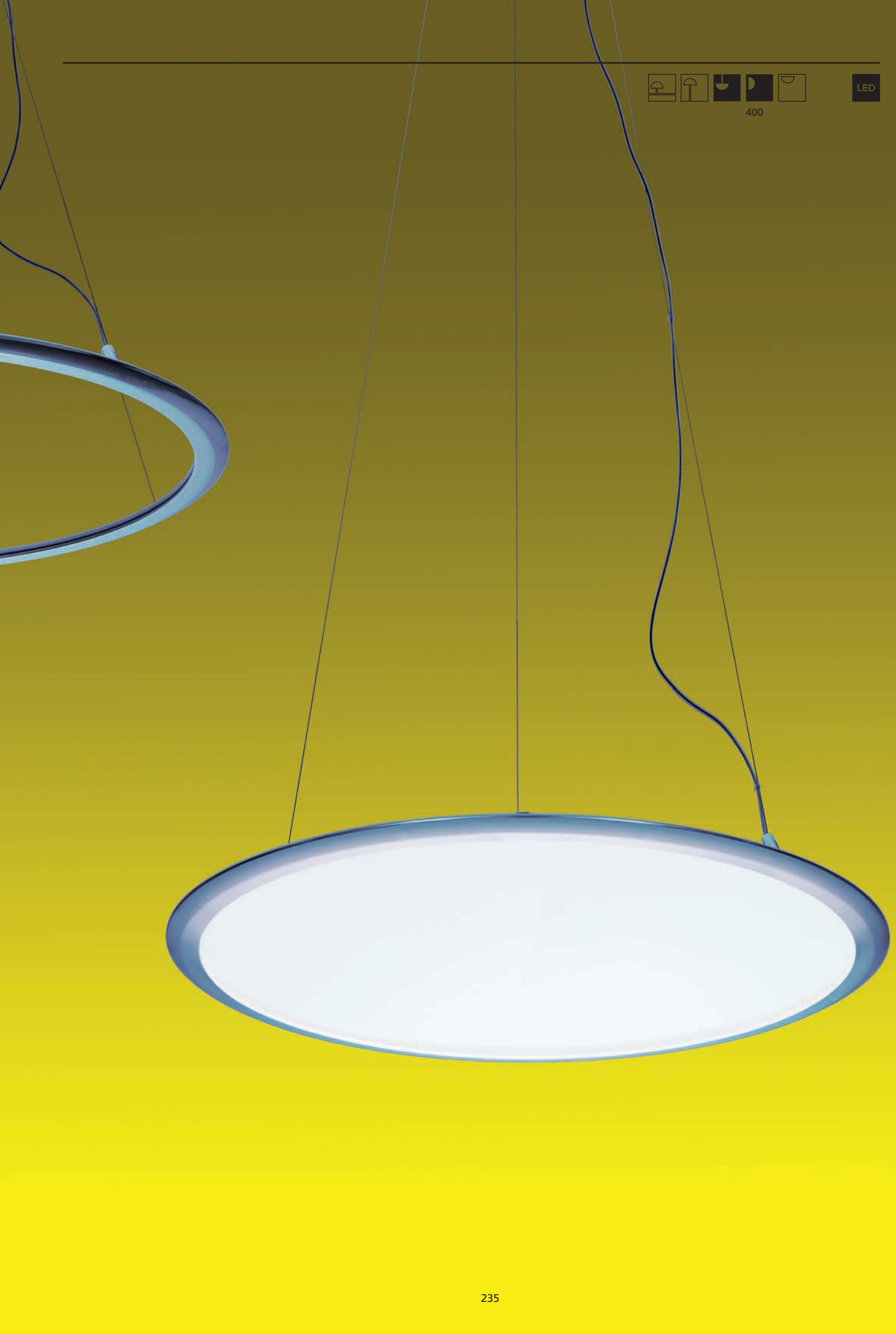





Light on

Spectral light prosegue il percorso di ricerca che da anni Artemide sviluppa sulla sostenibilità, la percezione psicologica e fisiologica. Dalla ricerca sulle lunghezze d'onda percepite non solo dall'uomo ma da differenti specie di animali e piante sono state selezionate quelle necessarie per vedere, per crescere, per nutrirsi dei benefici della luce.

Spectral light continues the research that Artemide has been developing for many years on sustainability, as well as on psychological and physiological perception. From research on wavelengths perceived both by man and by a variety of animal and plant species, the necessary ones were selected to see, grow, and enjoy the benefits of light.

Spectral light continue le parcours de recherche qu'Artemide poursuit depuis des années sur la durabilité, la perception psychologique et physiologique. Partant de la recherche sur les longueurs d'onde perçues non seulement par l'homme mais par différentes espèces d'animaux et de plantes, on a sélectionné celles qui sont nécessaires pour voir, grandir et se nourrir des bénéfices de la lumière.

Spectral light setzt den Suchpfad fort, den Artemide seit Jahren zur Nachhaltigkeit, psychologischen sowie physiologischen Wahrnehmung entwickelt. Die Forschung gilt Wellenlängen, die nicht nur vom Menschen wahrgenommen werden, sondern von verschiedenen Tieren und Pflanzen, die das Licht zum Sehen, zum Wachsen und um sich zu ernähren benötigen.

Spectral light continúa el recorrido de investigación que desde hace años Artemide desarrolla acerca de la sostenibilidad y la percepción psicológica y fisiológica. A partir de la investigación sobre las longitudes de onda, percibidas no solo por el hombre sino por diferentes especies de animales y plantas, se han seleccionado aquellas necesarias para ver, crecer y nutrirse de los beneficios de la luz.

Awards

2016 – Wallpaper Design Award
"Best Bright Ideas".



LED

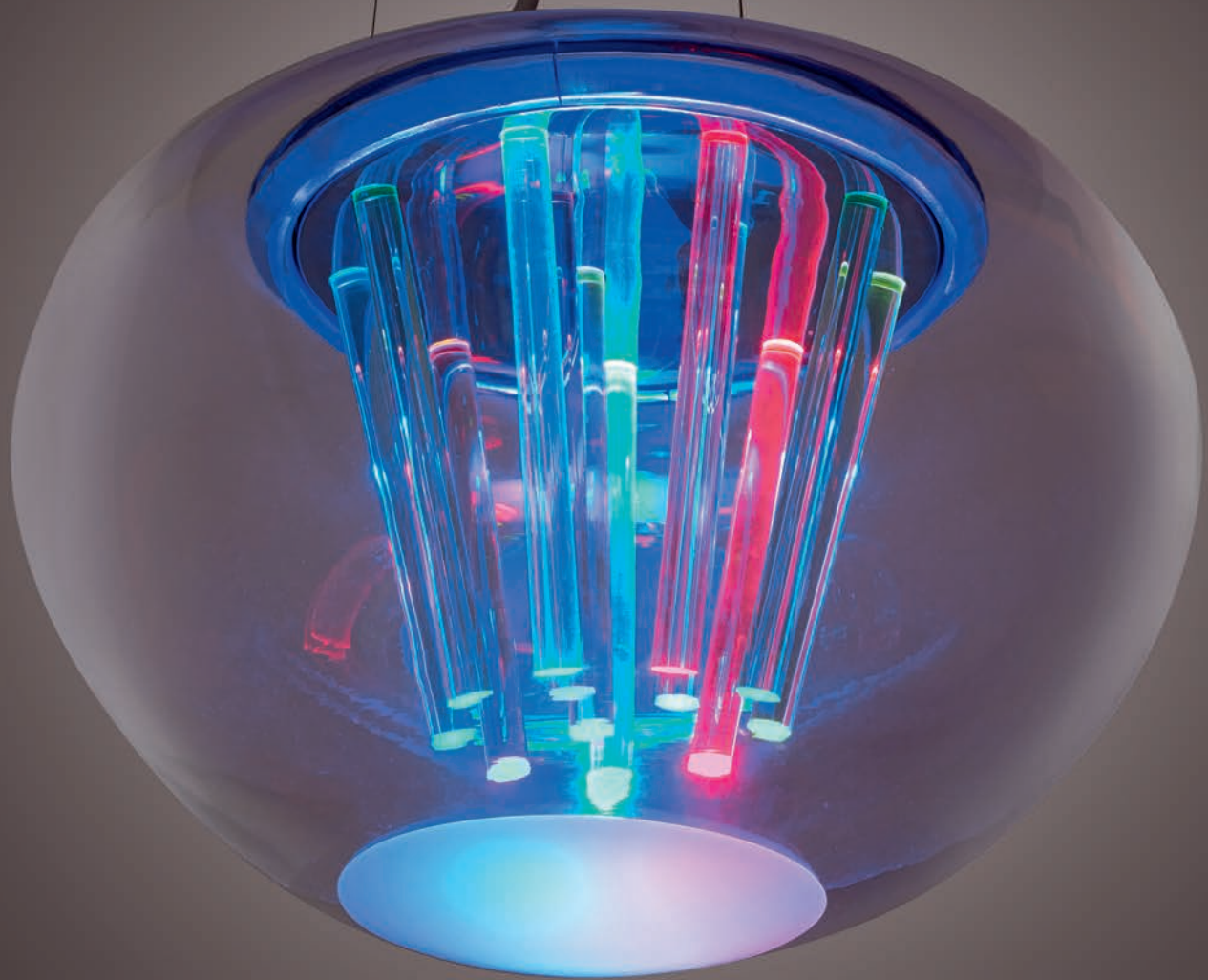

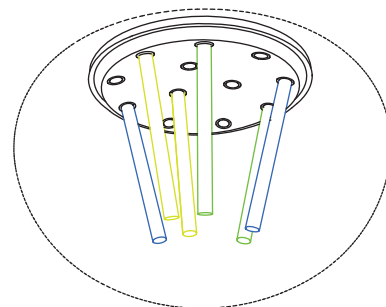
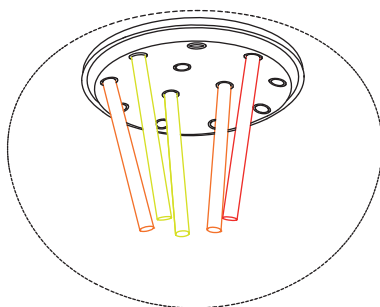
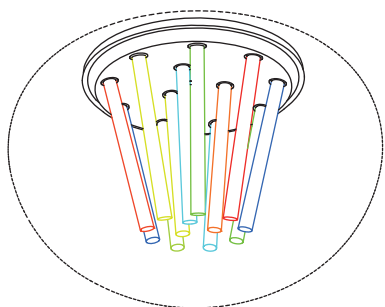
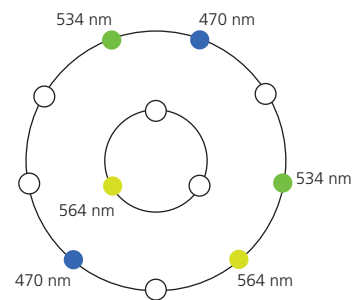
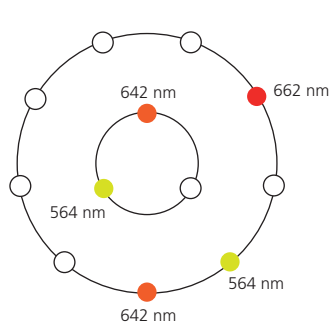
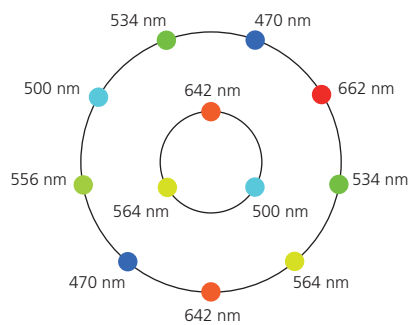

Day

Night

Human



Light emission

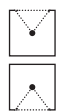

Colour



Transparent

Materiali

Struttura in alluminio, vetro soffiato, guide luce in metacrilato ottico.

Specificità

L'emissione diretta è determinata dai colori delle diverse lunghezze d'onda selezionate che possono miscelarsi per comporre una luce bianca. La lampada è dotata anche di un'emissione indiretta.

Materials

Aluminium frame, blown glass, optical methacrylate light tracks.

Specification

Direct emission is defined by the colours of the different selected wavelengths that can be mixed to obtain white emission. The appliance also features indirect emission.

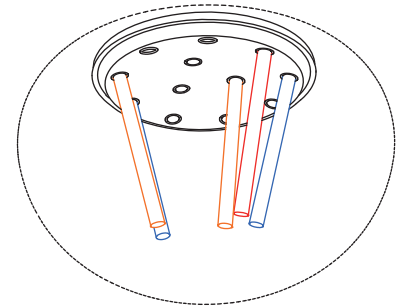
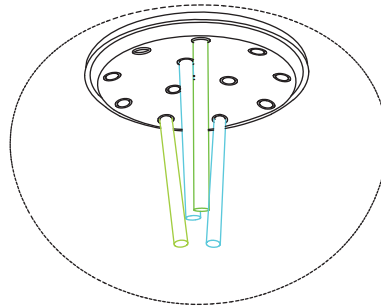
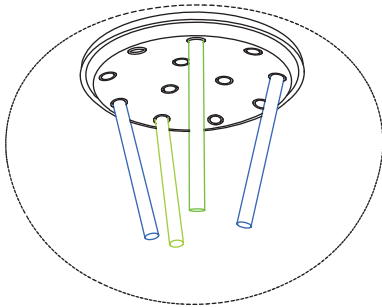
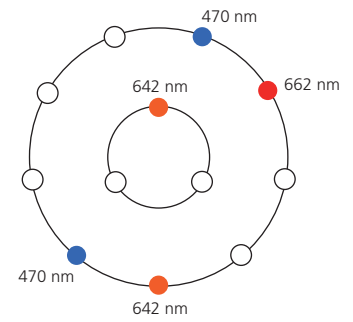
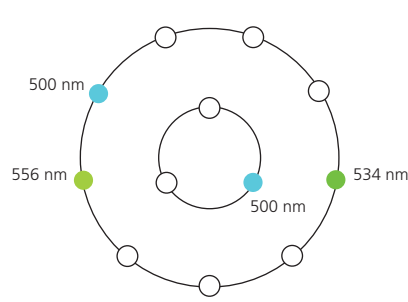
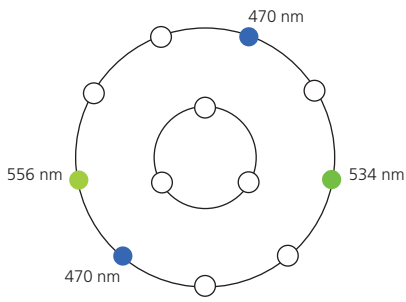

Dog

Cat

Plant



Matériaux

Structure en aluminium, verre soufflé, guides de lumière en méthacrylate optique.

Spécificités

L'émission directe est déterminée par les couleurs des différentes longueurs d'onde sélectionnées qui peuvent se mélanger pour composer une lumière blanche. La lampe est également équipée d'une émission indirecte.

Materialien

Leuchtenstruktur aus Aluminium, Die Lichtleiter sind aus Methacrylat.

Spezifikation

Die direkte Emission wird bestimmt von den Farben der verschiedenen ausgewählten Wellenlängen, die sich mischen können, um ein weißes Licht zu bilden. Die Leuchte ist zudem mit einer indirekten Lichtemission ausgestattet.

Materiales

Estructura de aluminio, vidrio soplado, guías luz de metacrilato óptico.

Especificaciones

La emisión directa está determinada por los colores de las diferentes longitudes de onda seleccionadas que pueden mezclarse componiendo una luz blanca. La lámpara también está equipada con una emisión indirecta.



Light emission



Colours



Transparent



Structure:
Polished black

Materiali

Struttura in alluminio, diffusore in metacrilato stampato a iniezione.

Specificità

Il sistema ottico e le differenti finiture sono appositamente progettati per disegnare la luce all'interno del corpo in metacrilato e trasformare la lampada in un disco di luce sospeso. Orsa è concepito per essere utilizzato sia singolarmente sia come elemento di una composizione.

Materials

Aluminium frame, injection-moulded methacrylate diffuser.

Specification

The optical system and the different finishes are especially conceived to design light within the methacrylate body and turn the appliance into a suspended light disc. Orsa is designed for use as a single unit or as an element of a composition.



LED



Matériaux

Structure en aluminium, diffuseur en méthacrylate moulé.

Spécificités

Le système optique et les différentes finitions sont conçus exprès pour dessiner la lumière à l'intérieur du corps en méthacrylate et transformer la lampe en un disque de lumière suspendu.

Materialien

Aluminium Struktur, Diffusor aus Methacrylat spritzgegossen.

Spezifikation

Das Leuchtsystem und die verschiedenen Ausführungen wurden speziell entwickelt, um das Licht im Inneren des Körpers aus geblasenem Methacrylat zu visualisieren und die Leuchte in eine hängende Lichtscheibe zu verwandeln. Orsa wurde entwickelt, um sie sowohl einzeln als auch als Element einer Komposition zu verwenden.

Materiales

Estructura de aluminio, difusor de metacrilato estampado a inyección.

Especificaciones

El sistema óptico y los diferentes acabados se han diseñado específicamente para dibujar la luz dentro del cuerpo de metacrilato y transformar la lámpara en un disco de luz suspendido. Orsa está pensado para ser utilizado solo o como elemento de una composición.

Orsa chandelier 3 Orsa chandelier 5

Foster + Partners
2017

Materiali

Struttura in alluminio, diffusore in metacrilato stampato a iniezione. Rosone in metallo con finitura mirror. Lo chandelier è composto da 3 o 5 elementi Orsa 21.

Materials

Aluminium frame, injection-moulded methacrylate diffuser. Metal ceiling rose with mirror finishing. The chandelier is composed of 3 or 5 Orsa 21 lamps.

Matériaux

Structure en aluminium, diffuseur en méthacrylate moulé. Le rosace est en métal avec finition miroir. Le chandelier est composé de 3 ou 5 lampes Orsa 21.

Materialien

Aluminium Struktur, Diffusor aus Methacrylat spritzgegossen. Deckenplatte aus Metall mit Spiegelveredelung. Das Cluster ist mit 3 oder 5 Orsa 21 Leuchten erhältlich.

Materiales

Estructura de aluminio, difusor de metacrilato estampado a inyección. La plancha de fijación es de metal con acabado espejo. La lámpara se compone de 3 ó 5 lámparas Orsa 21.

Light emission



Colours



Transparent



Structure:
Polished black



Orsa chandelier 3



LED

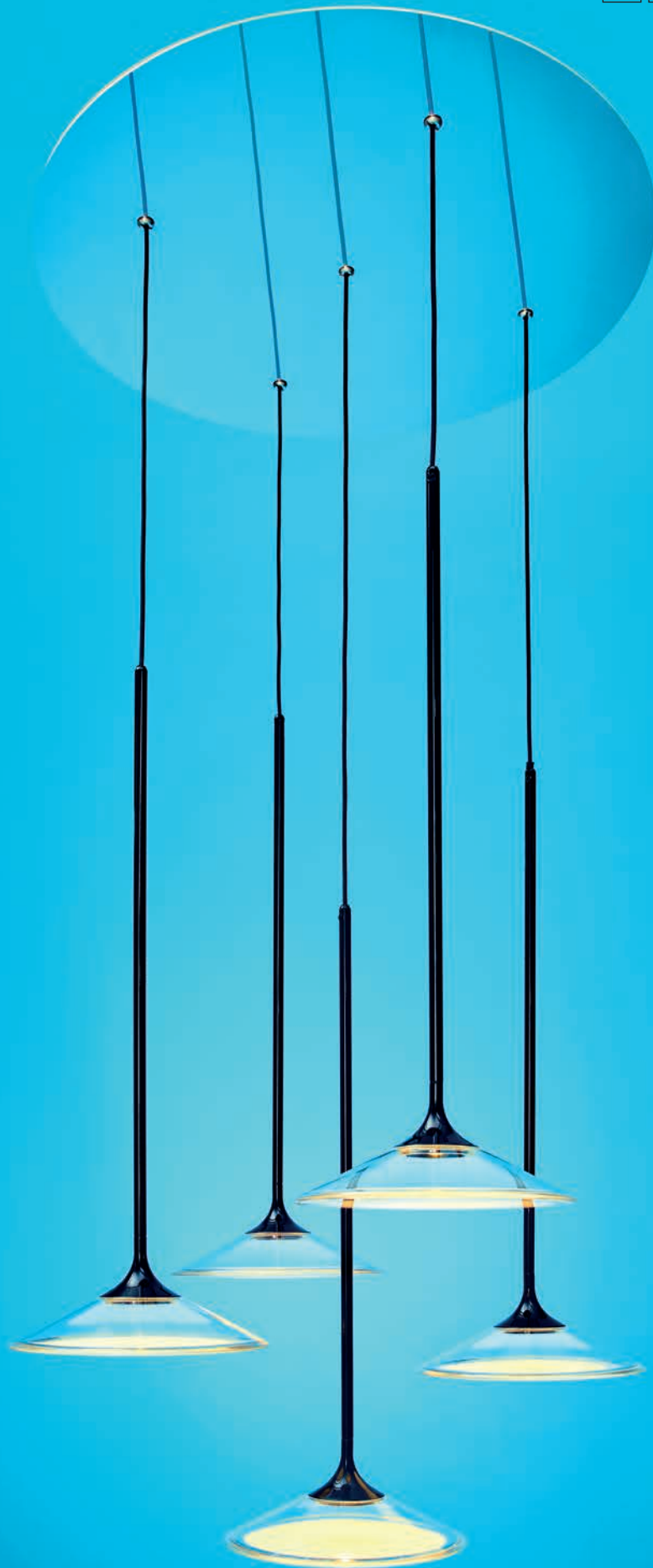

Orsa chandelier 5, photo by Pierpaolo Ferrari, 2017

Lampada a sospensione che coniuga il fascino estetico di un oggetto di altri tempi ad un alto valore tecnologico ed illuminotecnico.

Materiali

Corpo lampada realizzato con una pressofusione di alluminio o ottone; rosone a soffitto in tecnopolimero; piastra di fissaggio a soffitto in acciaio.

Specificità

La sorgente luminosa è un LED COB; il flusso luminoso è controllato anche da una lente in polimero ad alta efficienza ottica studiata appositamente per concentrare il fascio luminoso. Il corpo lampada ha una duplice funzione: dissipare il calore prodotto dalla sorgente ed indirizzare il flusso luminoso verso il basso.

A suspension lamp that combines the aesthetic charm of an old-time object with high technology and engineering.

Materials

Lamp body in die-cast aluminium or brass; ceiling rose in technopolymer; ceiling fixing plate in steel.

Specification

The light source is a COB LED to ensure a maximum luminous efficiency. The light beam is also controlled by a high-efficiency optic polymeric lens especially designed to collimate light. The lamp body has a dual function: dissipate the heat produced by the LED source and direct the luminous flow downwards.

Suspension qui conjugue le charme esthétique d'un objet d'autrefois à une haute valeur technologique et technique.

Matériaux

Corps réalisé en aluminium ou cuivre ; rosace en technopolymère ; plaque de fixation en acier.

Spécificités

La source lumineuse est une LED COB ; le flux lumineux est aussi contrôlé par une lentille en polymère à haute efficacité optique étudiée pour concentrer le faisceau lumineux. Le corps de la lampe a une double fonction : dissiper la chaleur produite par la source et maîtriser le flux lumineux.

Pendelleuchte die wurde Nostalgie eines antiken Objektes und höchsten technologischen Anspruch vereint.

Materialien

Leuchtenkörper hergestellt aus Aluminium oder Messing; Deckenbaldachin aus Technopolymer; Deckenbefestigungsplatte aus Stahl.

Spezifikation

Eine COB-LED fungiert als Lichtquelle, um maximalen Wirkungsgrad und niedrige Energiekosten zu gewährleisten. Die speziell entwickelte Linse aus Polymer ermöglicht optische Effizienz und einen konzentrierten Lichtstrahl. Der Leuchtenkörper lenkt das Licht nach unten und dient gleichzeitig der Wärmeableitung.

Lámpara de suspensión que conjuga la fascinación estética de un objeto de otros tiempos con un alto valor tecnológico y luminotécnico.

Materiales

Cuerpo lámpara realizado con una fundición de aluminio y latón; rosetón a techo en polímero; plancha de fijación a techo en acero.

Especificaciones

La fuente de luz es un LED COB; el flujo luminoso está controlado por una lente en polímero de alta eficiencia óptica estudiada a propósito para concentrar el haz luminoso. El cuerpo de la lámpara tiene una doble función: disipar el calor producido por la fuente de luz y direccionar el flujo luminoso hacia abajo.

Light emission



Colours



Brass



Aluminium

Awards

2017 - Reddot Design Award:
High Design Quality
Essen (Deutschland)

2016 - Best of Design plus Award







Pirce
Pirce mini
Pirce micro

Giuseppe Maurizio Scutellà
2008

Materiali

Alluminio verniciato.

Specificità

Da un disco sottile si aprono volute fluttuanti, che ricadono morbidamente verso il basso, creando magici effetti di forma e luce.

Materials

Painted aluminium.

Specification

From a thin ceiling plate, gently descending waving spirals create enchanting effects of form and light.

Matériaux

Aluminium verni.

Spécificité

Un disque mince donne naissance à des volutes flottantes qui retombent doucement vers le bas en créant des effets magiques de formes et de lumière.

Materialien

Lackiertes Aluminium.

Spezifikation

Eine feine Scheibe geht in sanft geschwungene Spiralen über, die sich spiralförmig nach unten neigen und magische Lichteffekte erzeugen.

Materiales

Aluminio pintado.

Especificaciones

De un disco fino parten volvas fluctuantes que caen suavemente hacia abajo, creando mágicos efectos de forma y luz.

Light emission



Colours



White



Gold
(only LED)

Awards

2010 – iF Produkt Design Award
Hannover (Deutschland)

2008 – Good Design Award
The Chicago Atheneum
Chicago (US)



420

516

LED

LED

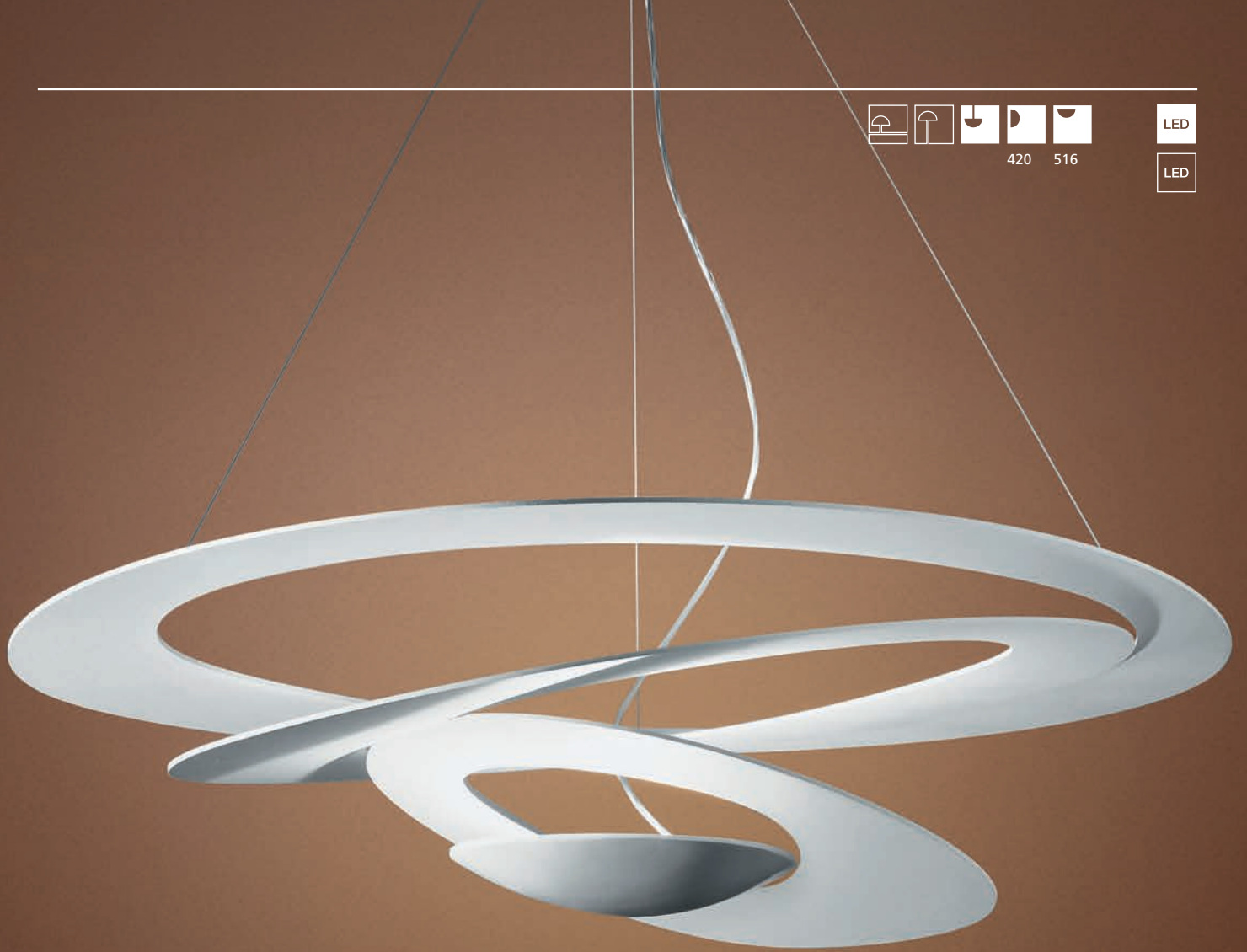



Pirce mini white

Pirce micro white



Pirce gold

Space Cloud

Ross Lovegrove
2014

Materiali

Layers microforati in alluminio anodizzato; corpo illuminante in pressofusione di alluminio lucidato; rosone in tecnopolimero plastico con rivestimento in alluminio lucido; cavi di sospensione in acciaio.

Specificità

Lampada a sospensione a LED caratterizzata da quattro layers che riflettono la luce emessa dalla sorgente posta nella parte inferiore, creando un piacevole effetto di luci ed ombre sul soffitto.

Materials

Layers in anodized aluminium; painted die-cast aluminium body lamp; ceiling rose in steel sheet; cover in technopolymer and aluminium; steel suspension cables.

Specificità

LED suspension lamp made of four layers in anodized aluminium reflecting the light emitted by the LED source at the bottom of the fitting, while producing a pleasant light and shading effects on the ceiling.

Matériaux

Couches en aluminium anodisé, corps en aluminium moulé sous pression peint ; rosace en lamelle d'aluminium et couverture en polymère, câbles de suspension en acier.

Spécificités

Suspension LED caractérisée par 4 superpositions du disque qui réfléchissent la lumière émise par la source positionnée dans la partie inférieure produisant ainsi un agréable effet de lumières et d'ombres au plafond.

Materialien

Schichten aus gelochtem, eloxiertem Aluminium; Leuchtenkörper aus druckgegossenem, poliertem Aluminium; Baldachin aus Technopolymer mit Aluminiumbeschichtung; Stahlseilaufhängung.

Spezifikation

Das Licht, das die im unteren Bereich sitzende LED Lichtquelle abgibt, wird durch die vier Ebenen reflektiert, wodurch ein bezaubernder Licht- und Schatteneffekt an der Decke entsteht.

Materiales

Capas de aluminio anodizado; cuerpo lámpara de aluminio fundido a presión; rosetón en polímero y cubierto de aluminio; cables de suspensión en acero.

Especificaciones

Lámpara de suspensión a LED caracterizada por cuatro capas que reflejan la luz emitida por la fuente de luz situada en la parte inferior creando un efecto placentero de luces y sombras en el techo.

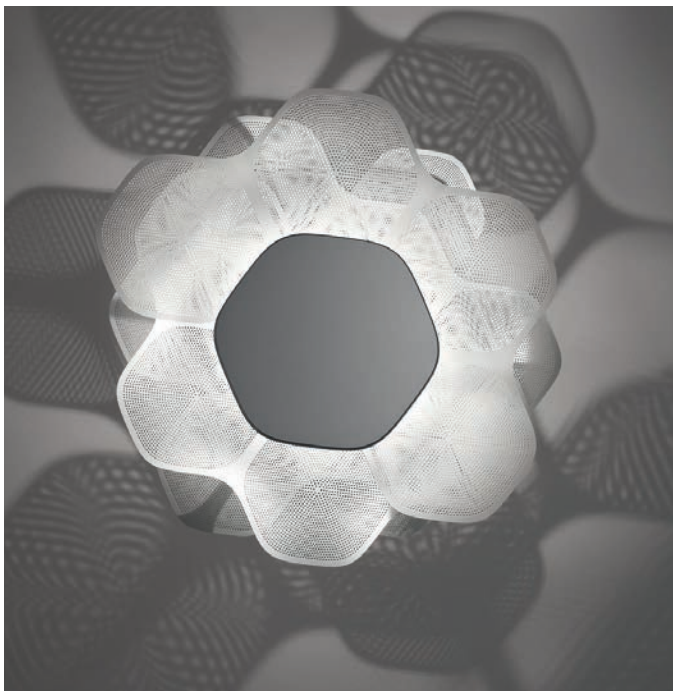

Light emission



Colours





LED





La ripetizione di un modulo elementare materializza una sfera incompleta, in sospeso.

Materiali

Struttura in alluminio pressofuso verniciato; lenti in metacrilato diffondente; rosone in tecnopolimero con finitura verniciata.

The repetition of a simple module creates an incomplete suspended structure.

Materials

Lamp body in die-cast aluminium; methacrylate lens; ceiling rose in technopolymer.

C'est une répétition d'un module élémentaire qui forme une sphère incomplète en suspension.

Matériaux

Corps réalisé en aluminium ; lentille en méthacrylate ; rosace en techno-polymère.

Durch Wiederholung eines elementaren Moduls wirkt diese Pendelleuchte wie eine Kugel mit unvollständiger Struktur.

Materialien

Leuchtenkörper aus lackiertem Aluminiumdruckguss; Linse aus Methacrylat; Deckenbaldachin aus lackiertem Technopolymer.



LED



La repetición de un módulo elemental se materializa en una esfera incompleta; en suspensión.

Materiales

Cuerpo lámpara realizado con una fundición de aluminio; lentes de metacrilato; rosetón a techo en polímero; plancha de fijación a techo en plancha de fijación a techo en polímero.

Awards

2013 - Reddot Design Award:
High Design Quality
Essen (Deutschland)
2014 - Design Plus Light+Building Award
Frankfurt (Deutschland)

Light emission



Colours



White/Black

Materiali

Alluminio anodizzato.

Specificità

Nove ellissi concentriche e mobili ricavate da un'unica lastra di alluminio supportano un circuito di 384 LED bianchi; le ellissi ruotano indipendentemente su due diversi assi, permettendo di orientare l'emissione luminosa e contemporaneamente di ottenere numerose configurazioni spaziali. Quando è chiuso l'apparecchio si presenta completamente piatto.

Materials

Anodised aluminium.

Specification

A circuit of 384 white LEDs is installed into nine concentric elements created from a single aluminium plate. The ellipses rotate independently on the two different axes, enabling the adjustment of the light emission and the creation of multiple configuration. When off the device is completely flat.

Matériaux

Aluminium anodisé.

Spécificité

Neuf ellipses concentriques et mobiles, obtenues à partir d'une seule plaque d'aluminium, soutiennent un circuit de 384 LEDs blanches. Ces ellipses tournent indépendamment sur deux axes différents, ce qui permet à la fois d'orienter l'émission de lumière et d'obtenir de nombreuses configurations spatiales.

Materialien

Eloxiertes Aluminium.

Spezifikation

Neun konzentrische, aus einer einzigen Aluplatte gefertigte Ellipsen, auf denen eine Leiterplatte mit 384 weißen LED angebracht ist. Die Ellipsen lassen sich unabhängig voneinander um zwei Achsen drehen, so dass eine individuelle Ausrichtung des Lichtstrahls erzielt wird und immer wieder neue Konfigurationen im Raum entstehen. In geschlossenem Zustand hat die Leuchte eine vollständig flache Form.

Materiales

Aluminio anodizado.

Especificaciones

Nueve elipses concéntricas y móviles, realizadas a partir de una única placa de aluminio, hacen de base a un circuito de 384 LEDs blancos. Las elipses giran independientemente a lo largo de dos ejes diferentes, detalle que permite orientar el haz luminoso y obtener paralelamente numerosas configuraciones espaciales. Cuando el artefacto está cerrado es completamente plano.

Light emission

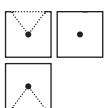

Colours

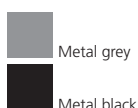

Awards

2011 – Design Innovationen
Design Zentrum Nordrhein Westfalen
Reddot Design Award
Essen (Deutschland)
2014 – Compasso d'Oro / A.D.I.
Milano (Italia); Honorable Mention

Patent Pending
n. MI20104000610



LED

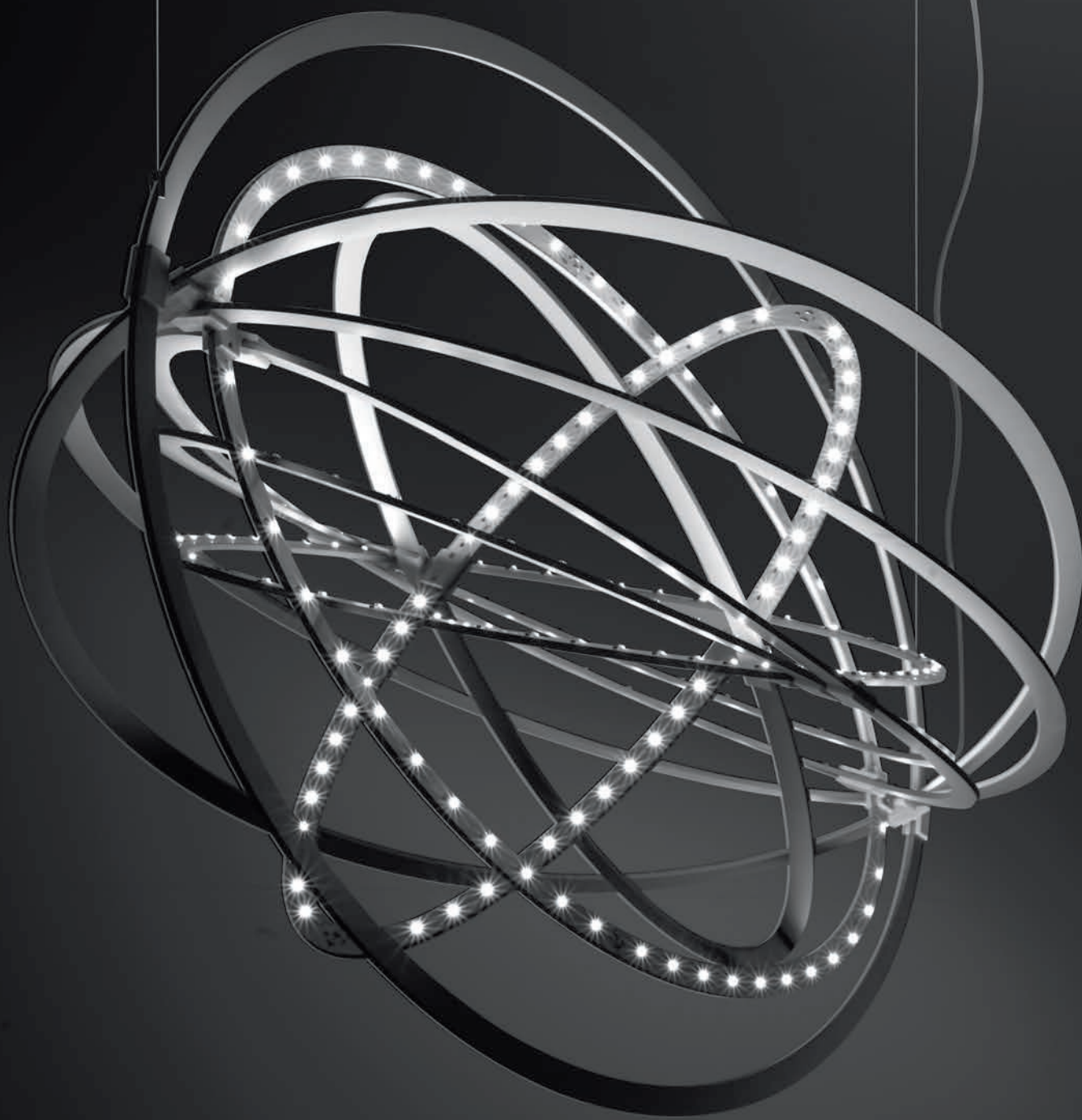

Copernico metal grey

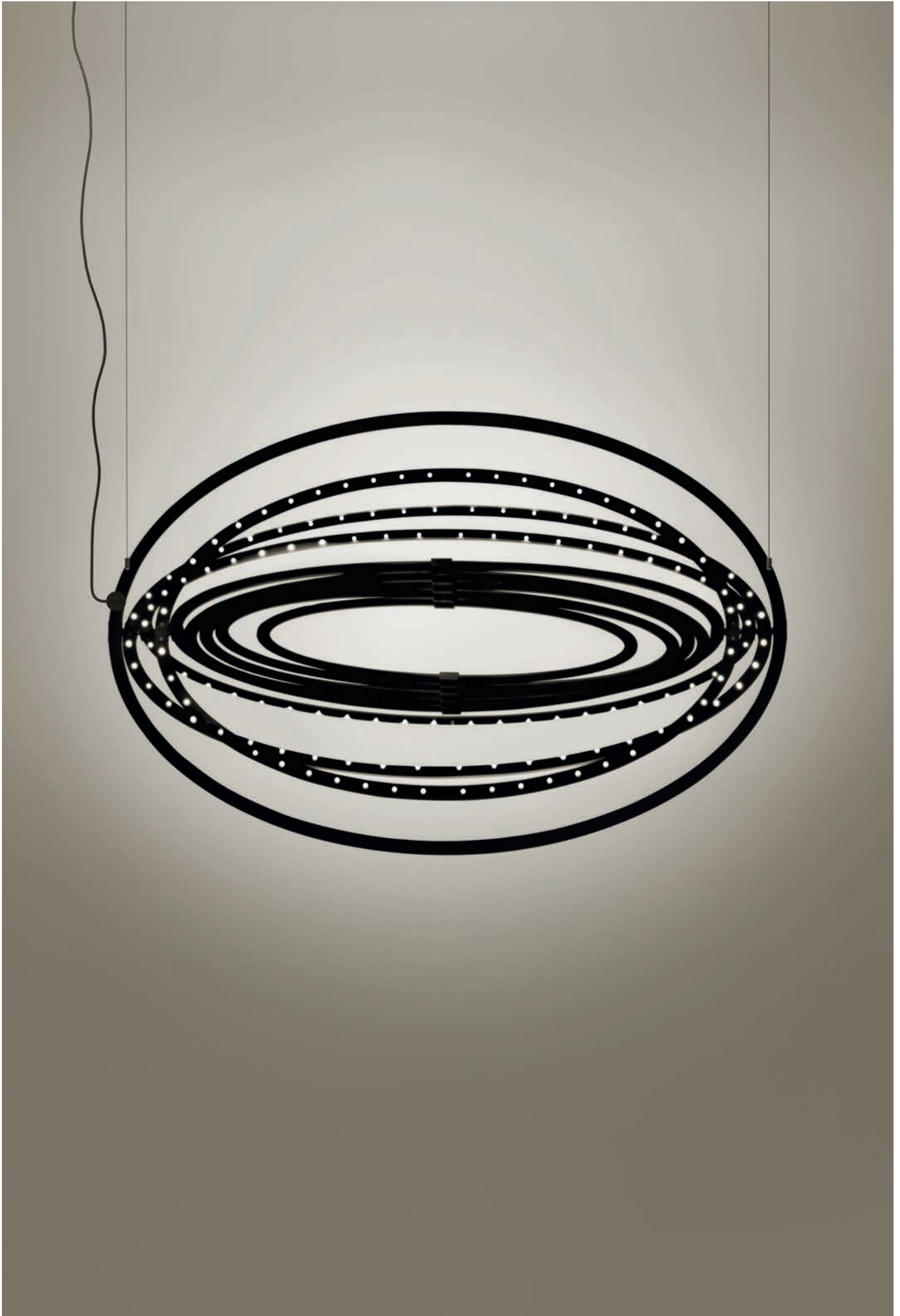

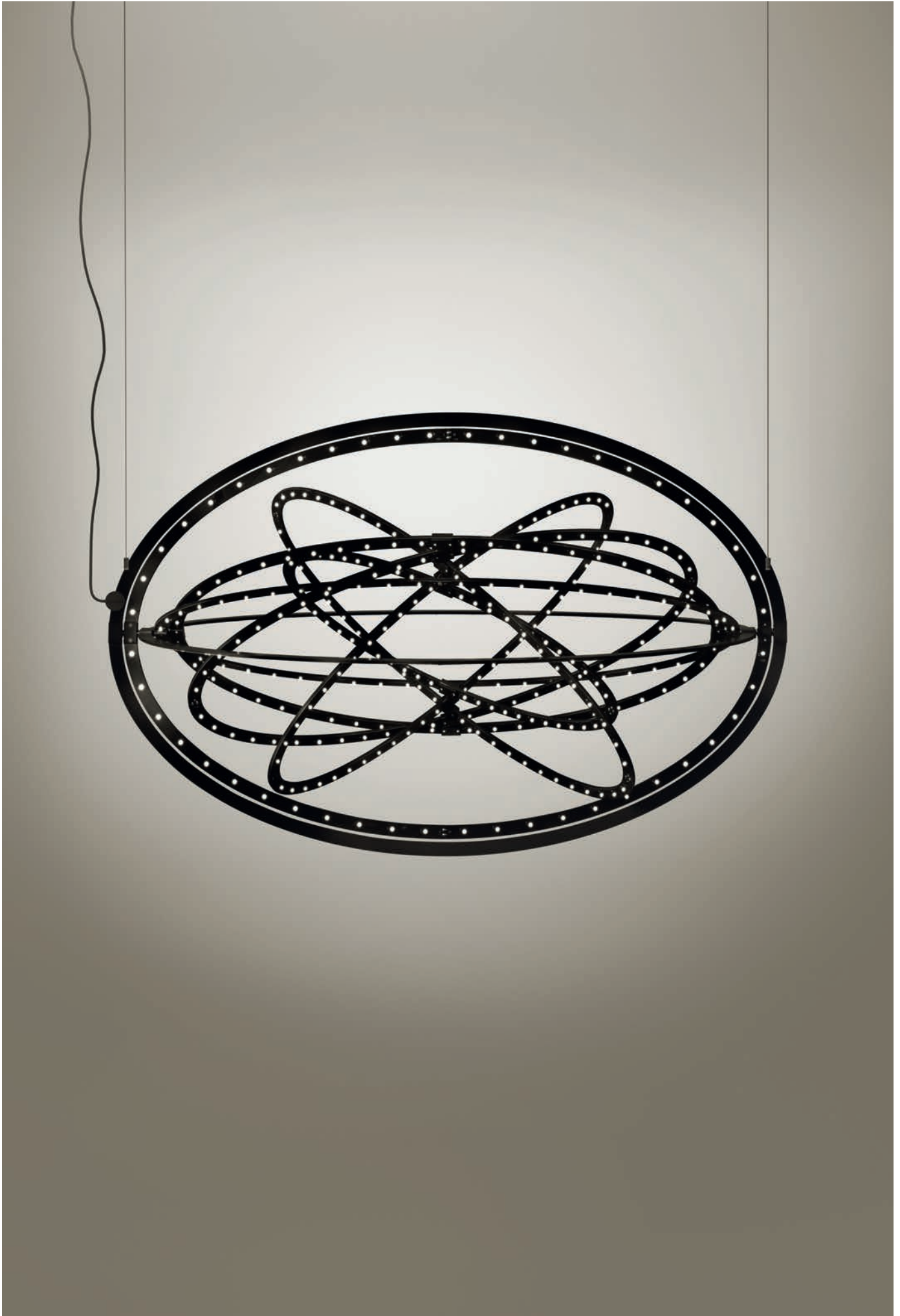

Copernico 500

Carlotta de Bevilacqua
Paolo Dell'Elce
2012

Copernico è ricavato da un unico foglio di alluminio tagliato al laser e verniciato; quando chiuso l'apparecchio si presenta completamente piatto. Lo snodo con contatti in rame (patent pending) permette il passaggio dell'alimentazione tra le ellissi concentriche che compongono la struttura, e abilita la rotazione indipendente di 360° di queste. La mobilità degli elementi e le sorgenti LED in bassissima tensione permettono all'utente di configurare la luce nello spazio impugnando e muovendo fisicamente l'oggetto, modulando l'emissione a seconda delle esigenze.

Materiali

Alluminio verniciato; PCB.

Copernico is obtained from a single laser-cut sheet of painted aluminium; when off the device appears completely flat. The articulation with copper contacts (patent pending) allows the power supply to pass between the concentric ellipses that make up the structure, and enables these to be rotated independently over 360°. The mobility of the elements and the low voltage LED light sources allow users to configure the light in space by clasp and physically moving the object, modulating emission according to need.

Materials

Painted aluminium; PCB.

Copernico est réalisée avec une seule feuille en aluminium verni découpée au laser. Quand il est fermé, l'appareil se présente sous une forme complètement plate. L'articulation à contacts en cuivre (patent pending) assure le passage de l'alimentation entre les ellipses concentriques qui composent la structure et permet à chacune de ces dernières de tourner sur 360°. La mobilité des éléments et les sources LED à très basse tension permettent à l'utilisateur de configurer la lumière dans l'espace, en saisissant et en déplaçant matériellement l'objet, en modulant l'émission en fonction des exigences.

Matériaux

Aluminium peint; PCB.

Copernico wird mit Lasertechnik aus einer eloxierten lackiert Aluminiumplatte ausgeschnitten und lackiert; die geschlossene Leuchte ist ganz flach. Das Gelenk mit den Kupferkontakten (zum Patent angemeldet) ermöglicht den Übergang der Stromversorgung zwischen den konzentrischen Ellipsen der Struktur und die voneinander unabhängige 360°-Drehung derselben. Die Mobilität der Elemente und der mit Kleinspannung funktionierenden LED-Lichtquellen ermöglicht es dem Benutzer, das Licht im Raum einfach durch Anfassen und Bewegen der Leuchte zu konfigurieren und den Lichtaustritt nach individuellem Bedarf zu steuern.

Materialien

Lackiertes Aluminium; PCB.

Copernico se construye a partir de una sola hoja de aluminio pintado, que se corta con láser. Cuando está cerrada, queda completamente plana. La articulación con contactos de cobre (cuya patente se está tramitando) permite modificar la alimentación, pasando a través de las elipses concéntricas que forman la estructura. Y acciona la rotación independiente de las mismas a 360°. La capacidad de movimiento de los elementos y las fuentes luminosas de LED de muy baja tensión hacen que el usuario logre configurar la luz en el espacio. Para modular la emisión a voluntad, basta empujar y desplazar el objeto.

Materiales

Aluminio pintado; PCB.

Light emission

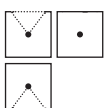

Colours

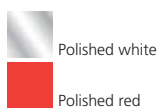

Awards

2011– Design Innovationen
Design Zentrum Nordrhein Westfalen
Reddot Design Award
Essen (Deutschland)
2014 – Compasso d'Oro / A.D.I.
Milano (Italia); Honorable Mention

Patent Pending
n. MI20104000610



LED



Copernico polished red



Artemide



Arcenide

Led Net line 66, 125 suspension

Michele De Lucchi
Alberto Nason
2010

Materiali

Struttura in alluminio verniciato. Ogni LED è dotato di lente in metacrilato trasparente e di porta-lente in metacrilato satinato.

Specificità

Modulo componibile che permette numerose aggregazioni (fornito come progetto custom). Grazie al ridotto cono di emissione (70°), Led Net line è anche adatto per uffici, dove è richiesto il controllo dell'abbagliamento.

Materials

Painted aluminium structure. Each LED is fitted with a transparent methacrylate lens and a satin finish methacrylate lens-holder.

Specification

Modular unit allowing the addition of multiple elements (supplied as custom products). Thanks to its reduced angular emission cone (70°), Led Net line is also suitable for offices, where glare control is needed.

Matériaux

Structure en aluminium peint. Chaque LED est munie d'une lentille en méthacrylate transparent et d'un porte-lentille en méthacrylate satiné.

Spécificité

Module unitaire permettant de nombreuses compositions (produit spécial à définir pour tout projet). Grâce au réduit cône d'émission (70°), Led Net line est également adapté pour les bureaux, où le contrôle d'éblouissement est nécessaire.

Materialien

Struktur aus lackiertem Aluminium. Alle LED mit Linse aus transparentem Methacrylat und Linsenträger aus mattem Methacrylat.

Spezifikation

Die Einzelelemente können als kundenspezifische Lichtlösung zu einer großen Konfiguration zusammen gefügt werden. Dank des kleinen Abstrahlwinkels (70°), ist Led Net line auch für Büros geeignet, in denen ein Blendschutz erforderlich ist.

Materiales

Estructura de aluminio pintado. Cada LED consta de lente de metacrilato transparente y de porta-lente de metacrilato satinado.

Especificaciones

Módulos componibles que permiten numerosas composiciones (suministro como proyecto especial). Gracias al cono de emisión reducida (70°), Led Net line es también apto para oficinas, donde se requiere el control del deslumbramiento.

Light emission



Colour



Polished white

Awards

Led Net line 125 suspension

2010 – IF Produkt Design Award
Design Quality
Hannover (Deutschland)

2012 – Design Plus Light+Building Award
Frankfurt (Deutschland)



Led Net line 66 suspension



Led Net line 125 suspension



Led Net circle suspension

Michele De Lucchi
Alberto Nason
2010

Materiali

Struttura in alluminio verniciato. Ogni LED è dotato di lente in metacrilato trasparente e di porta-lente in metacrilato satinato.

Specificità

Grazie al ridotto cono di emissione (70°), Led Net circle è anche adatto per uffici, dove è richiesto il controllo dell'abbagliamento.

Materials

Painted aluminium structure. Each LED is fitted with a transparent methacrylate lens and a satin finish methacrylate lens-holder.

Specification

Thanks to its reduced angular emission cone (70°), Led Net circle is also suitable for offices, where glare control is needed.

Matériaux

Structure en aluminium peint. Chaque LED est munie d'une lentille en méthacrylate transparent et d'un porte-lentille en méthacrylate satiné.

Spécificité

Grâce au réduit cône d'émission (70°), Led Net circle est également adapté pour les bureaux, où le contrôle d'éblouissement est nécessaire.

Materialien

Struktur aus lackiertem Aluminium. Alle LED mit Linse aus transparentem Methacrylat und Linsenträger aus mattem Methacrylat.

Spezifikation

Dank des kleinen Abstrahlwinkels (70°), ist Led Net circle auch für Büros geeignet, in denen ein Blendschutz erforderlich ist.

Materiales

Estructura de aluminio pintado. Cada LED consta de lente de metacrilato transparente y de porta-lente de metacrilato satinado.

Especificaciones

Gracias al cono de emisión reducida (70°), Led Net circle es también apto para oficinas, donde se requiere el control del deslumbramiento.

Light emission



Colour



Polished white

Awards

Led Net line 125 suspension

2010 – IF Produkt Design Award
Design Quality
Hannover (Deutschland)

2012 – Design Plus Light+Building award
Frankfurt (Deutschland)



Fiamma suspension

Wilmotte & Industries
2014

Materiali

Corpo della lampada in alluminio estruso modellato meccanicamente; rosone a soffitto in tecnopolimero verniciato.

Materials

Milled aluminium extruded body, painted engineering plastic ceiling rose.

Matériaux

Corps de la lampe en aluminium extrudé fraisé, rosace au plafond en technopolymère verni.

Materialien

Leuchtenkörper aus gefrästem, extrudiertem Aluminium, Deckenrosette aus transparentem Technopolymer.

Materiales

Cuerpo lámpara de aluminio extruido fresado, rosetón de techo de tecnopolímero pintado.



Light emission



Colours



Anodized black



Anodized grey

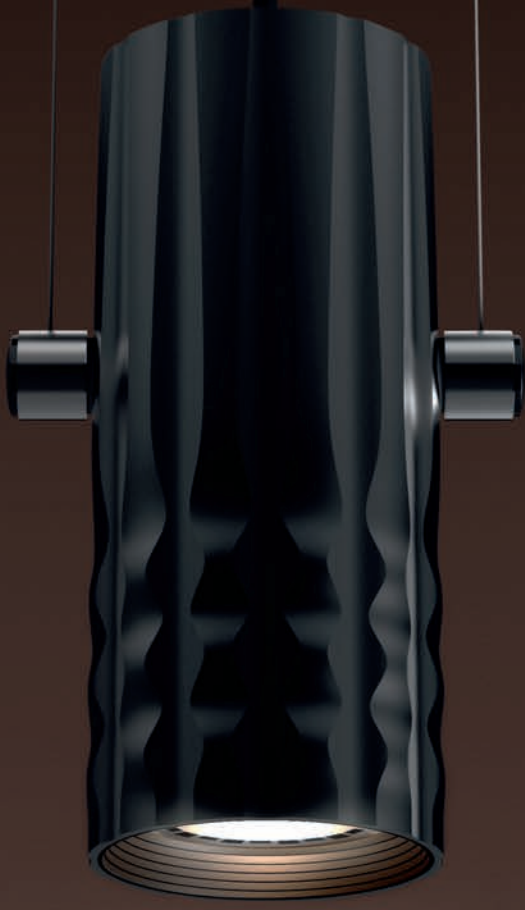

Materiali

Corpo della lampada in alluminio estruso modellato meccanicamente; rosone a soffitto in tecnopolimero verniciato.

Materials

Milled aluminium extruded body, painted engineering plastic ceiling rose.

Matériaux

Corps de la lampe en aluminium extrudé fraisé, rosace au plafond en technopolymère verni.

Materialien

Leuchtenkörper aus gefrästem, extrudiertem Aluminium, Deckenrosette aus transparentem Technopolymer.

Materiales

Cuerpo lámpara de aluminio extruido fresado, rosetón de techo de tecnopolímero pintado.

Light emission



Colours



Anodized black



Anodized grey



166



506



LED



Null Vector

Carlotta de Bevilacqua
Laura Pessoni
2013

Materiali

Corpo in alluminio forato e tranciato; diffusore in metacrilato satinato texturizzato; rosone in tecnopolimero.

Specificità

L'intera struttura, caratterizzata da un pattern di fori, si genera da una crescita scalare di un singolo stampo di foratura e tranciatura che si declina nelle due versioni Alfa e Beta.

Materials

Body in punctured and sheared aluminum; diffuser in textured satin methacrylate, ceiling rose in technopolymer.

Specification

The whole structure features an escalating growth of a single puncture and shear mould designed in two versions, Alfa and Beta.

Matériaux

Corps en aluminium percé ; diffuseur en méthacrylate satiné texturisé; rosace en techno-polymère.

Spécificités

La structure, caractérisée par un ensemble de trous, se développe à partir d'une croissance progressive de perçage. Elle se décline en version Alfa et Beta.

Materialien

Körper aus gelochtem und gestanztem Aluminium; Schirm aus satiniertem, strukturiertem Metacrylat; Deckenbaldachin aus Technopolymer.

Spezifikation

Das Muster wurde aus einer stetig wachsenden Form aus Lochungen und Stanzungen generiert und auf die zwei Versionen Alfa und Beta zugeschnitten.

Materiales

Cuerpo en aluminio perforado y cortado; difusor en metacrilato satinado; rosetón a techo en polímero.

Especificaciones

Toda la estructura, caracterizada por un dibujo de agujeros, se forma por un aumento del estampado de agujeros y corte de molde, diseñado en las dos versiones Alfa y Beta.

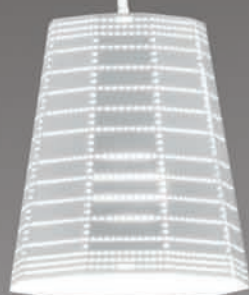
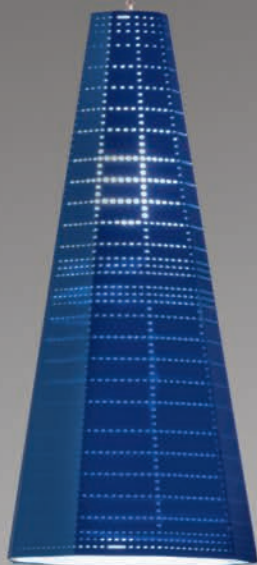

Light emission



Colours



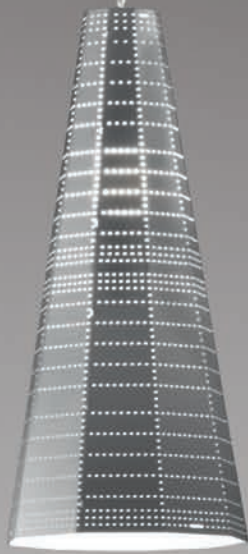

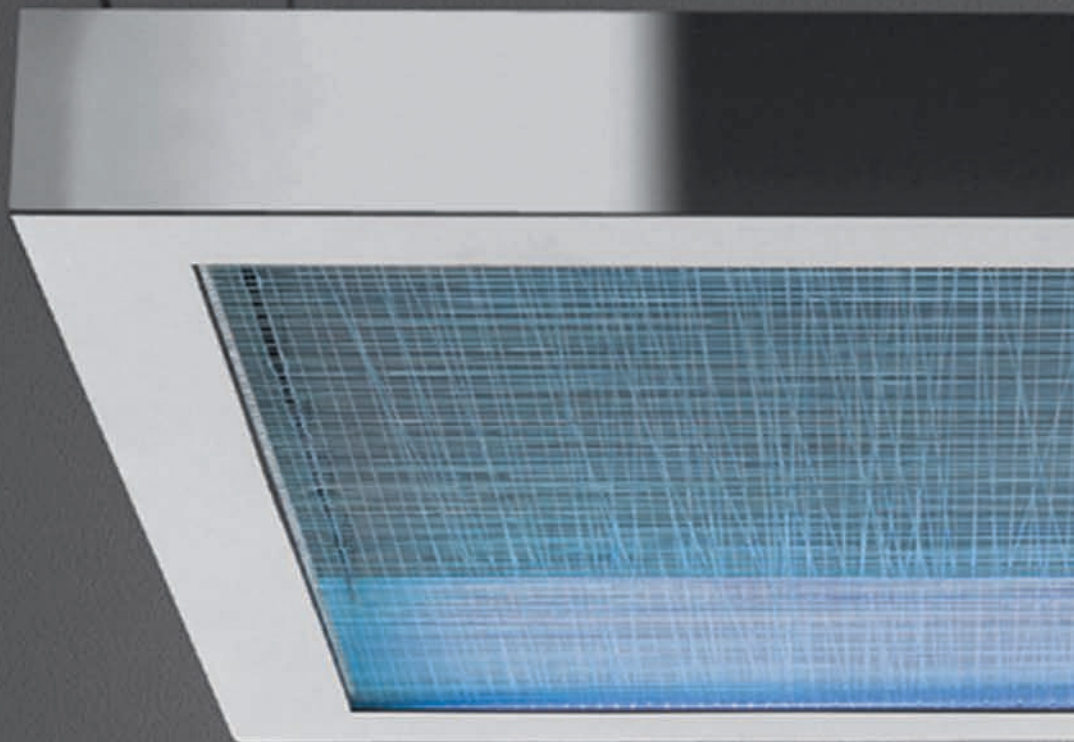

"Un m² di superficie dove la luce scorre fluida su fili trasparenti che attraverso un riflettore a specchio materializza un effetto luminoso volumetrico e controllato. È un m³ di luce nel quale ci si riflette all'infinito modulando liberamente più di un milione di effetti cromatici. Lo spazio non è più uno, ma diventa molti o semplicemente altro, percezione illusoria della realtà che porta verso un nuovo luogo, altrove."

"In a m² of surface where the light flows in a fluid way on transparent wires and, through a mirrored reflector, materializes a lighting and volumetric effect which is controlled. It is a cubic metre of light where everything is endlessly reflected, freely modulating more than a million of chromatic effects. The space is no more just one, but several, or simply "else", illusory perception of reality, which drives to a new place, elsewhere."

"Un m² de surface où la lumière entre avec fluidité sur des fils transparents et au travers d'un réflecteur miroir. Altrove matérialise un éclairage à effet volumétrique commandé. C'est un mètre cube de lumière où celle-ci se réfléchit sans fin et qui module librement plus d'un million d'effets chromatiques. L'espace n'en est plus un mais plusieurs ou simplement autre chose, perception illusoire de la réalité, qui mène à un nouvel endroit, ailleurs."

"Auf einer Fläche von einem Quadratmeter auf der das Licht in fließender Bewegung über transparente Nylonkabel geleitet und durch eine Spiegelfläche reflektiert wird, materialisiert sich das Licht und erzeugt einen einzigartigen, strukturierten Volumeneffekt. In einem Quadrat aus Licht" das sich ins Endlose reflektiert, werden Millionen von farbigen Effekten erzeugt. Die Fläche hat damit nicht mehr nur eine, sondern viele oder einfach "weitere" scheinbare Realitäten, die zu einer neuen Dimension führen."

"Para materializar un efecto luminoso volumétrico y controlado, se ha creado un metro cuadrado de superficie donde la luz discurre con fluidez sobre hilos transparentes que cruzan un reflector en forma de espejo. Se trata de un metro cúbico de luz en el cual reflejarse hacia el infinito modulando libremente más de un millón de efectos cromáticos. El espacio ya no es único, sino que se convierte en una multitud de espacios o simplemente en uno distinto, en una percepción ilusoria de la realidad que nos conduce a un nuevo lugar, más allá."



LED

496
498

496
498

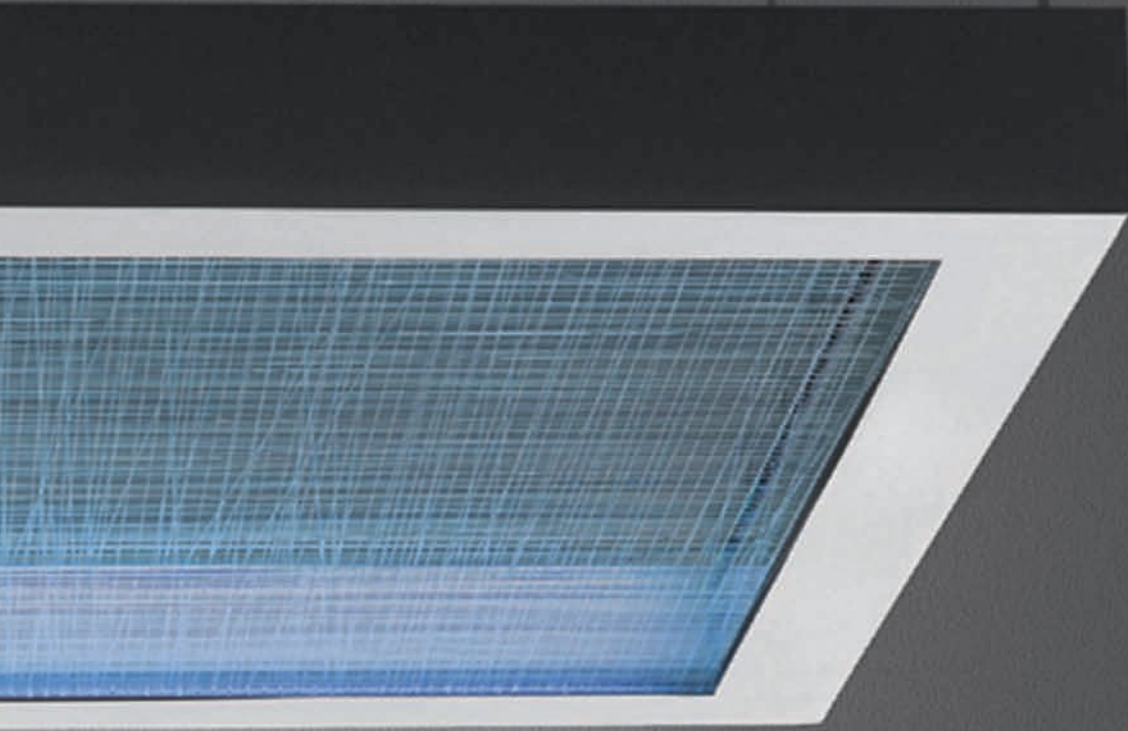

Altrove LED suspension

Carlotta de Bevilacqua
2008

Materiali

Struttura perimetrale in acciaio inox a specchio; diffusori laterali in Prismoptic satinato; diffusore frontale in metacrilato trasparente inciso; diffusore superiore in PETG trasparente.

Specificità

Sono disponibili le versioni a luce diretta e a doppia emissione.

Materials

Mirror stainless steel perimeter structure; side diffusers made of opaline Prismoptic; front diffuser in transparent engraved methacrylate; upper diffuser in transparent PETG.

Specification

Two versions are available: direct emission and direct/indirect emission.

Matériaux

Structure périmétrale en acier inoxydable miroitant ; diffuseurs latéraux en Prismoptic opalin ; diffuseur frontal en méthacrylate transparent strié ; diffuseur supérieur en PETG transparent.

Spécificité

Deux versions sont disponibles: émission directe et double émission.

Materialien

Rahmen aus verspiegeltem Edelstahl; seitliche Reflektoren mit opaliner Prismoptic; Frontscheibe aus transparentem, graviertem Methacrylat; oberer Diffusor aus transparentem PETG.

Spezifikation

Erhältlich mit direktem sowie direkt-indirektem Lichtaustritt.

Materiales

Estructura perimetral de acero inoxidable con acabado espejo, difusores laterales de Prismoptic opalino, difusor frontal de metacrilato transparente; difusor superior en PETG transparente.

Especificaciones

Están disponibles dos versiones: emisión directa y doble emisión.

Light emission



Colour



Radiofrequency
remote control
(included)



Altrove 600 LED suspension

Carlotta de Bevilacqua
2010

Materiali

Struttura perimetrale in acciaio inox a specchio; diffusori laterali in Prismoptic satinato; diffusore frontale in metacrilato trasparente inciso; diffusore superiore in PETG trasparente.

Specificità

Sono disponibili le versioni a luce diretta e a doppia emissione.

Materials

Mirror stainless steel perimeter structure; matt finish Prismoptic lateral diffusers; engraved transparent methacrylate front diffuser; transparent PETG upper diffuser.

Specification

Two versions are available: direct emission and direct/indirect emission.

Matériaux

Structure périmétrale en acier inoxydable miroitant ; diffuseurs latéraux Prismoptic satiné ; diffuseur frontal en méthacrylate transparent gravé ; diffuseur supérieur en PETG transparent.

Spécificité

Deux versions sont disponibles: émission directe et double émission.

Materialien

Rahmen aus verspiegeltem Edelstahl, seitliche Reflektoren mit opaliner Prismoptic; Frontscheibe aus transparentem, gravierten Methacrylat; oberer Diffusor aus transparentem PETG.

Spezifikation

Erhältlich mit direktem sowie direkt-indirektem Lichtaustritt.

Materiales

Estructura perimétrica de acero inoxidable con acabado espejo. Difusores laterales de Prismoptic satinado. Difusor frontal de metacrilato transparente grabado. Difusor superior de PETG transparente.

Especificaciones

Están disponibles dos versiones: emisión directa y doble emisión.

Light emission



Colours





Materiali

Struttura in alluminio e metacrilato; diffusore in policarbonato opalino; finitura esterna della lampada e del rosone a specchio.

Specificità

Riduce dell'80% i consumi mantenendo le prestazioni, nel segno della sostenibilità e in seguito agli sviluppi della tecnologia delle sorgenti. Utilizza tre sistemi luminosi per luce diretta, indiretta e diffusa, gestibili separatamente. In emissioni diretta e indiretta sono utilizzate sorgenti LED, mentre per quella diffusa sono utilizzate strisce LED RGB, che producono 6 varianti di luce colorata e una di luce bianca.

Materials

Aluminium and methacrylate structure; opal polycarbonate diffuser; mirror finish of the external side and of the ceiling rose.

Specification

Following the advances in technology and sustainability, Tian Xia 500 LED allows equal performances with a 80% energy saving. It uses three systems for direct, indirect and diffused light, which can be operated separately. LED light sources are employed in the direct and indirect emissions, while strips of RGB LEDs are used in the diffused emission, emitting 6 coloured and one white light ranges.

Matériaux

Structure en aluminium et méthacrylate ; diffuseur en opaline polycarbonate ; finition externe de la lamp et du rosace miroir.

Spécificité

Tian Xia 500 LED réduit la consommation énergétique de 80% tout en maintenant les performances, et ceci dans une démarche de développement durable suite à l'évolution technologique des sources. Elle utilise trois systèmes lumineux : lumière directe, indirecte et diffuse, pilotés séparément. Pour l'émission de lumière directe et indirecte, des sources LED sont utilisées et, pour obtenir une lumière diffuse on emploie des LED RGB, permettant d'obtenir 6 ambiances colorées et une de lumière blanche.

Materialien

Gehäuse aus Aluminium und Methacrylat; Schirm aus opalinem Polycarbonat; äußere Leuchte Oberfläche und Rosette hochglanzpoliert.

Spezifikation

Als Ergebnis der stetigen Forschung im Bereich der LED-Technologie und als Zeichen der Nachhaltigkeit reduziert die Tian Xia 500 LED den Energieverbrauch bei gleich bleibender Lichtleistung um 80%. Drei unabhängige Steuerungssysteme für die direkte, indirekte und gestreute Lichtverteilung. Die direkte und indirekte Lichtsteuerung erfolgen über LED-Lampen, die gestreute Lichtverteilung über LED-RGB (6 farbige Lichtstimmungen sowie Weißlicht).

Materiales

Estructura en aluminio y metacrilato; difusor en policarbonato opalino; acabado externo de la lámpara y rosetón espejo.

Especificaciones

Tian Xia 500 LED reduce un 80% los consumos, manteniendo al mismo tiempo, las prestaciones, en un signo de la sostenibilidad y la raíz de los acontecimientos en la tecnología de fuentes de luz. Incorpora tres sistemas luminosos para luz directa, indirecta y difusa, gestionados separadamente. Para la emisión directa e indirecta se utilizan fuentes de LED, mientras para la emisión difusa se utilizan fuentes de luz LED RGB, que permiten obtener 6 variantes de luz de color y una luz blanca.

Light emission

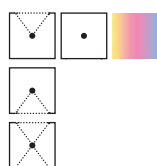

Colours



Awards

2010 – Green Good Design Award
The Chicago Athenaeum
Chicago (US)



Radiofrequency
remote control
(included)

Patent

n. 03014108.9



LED



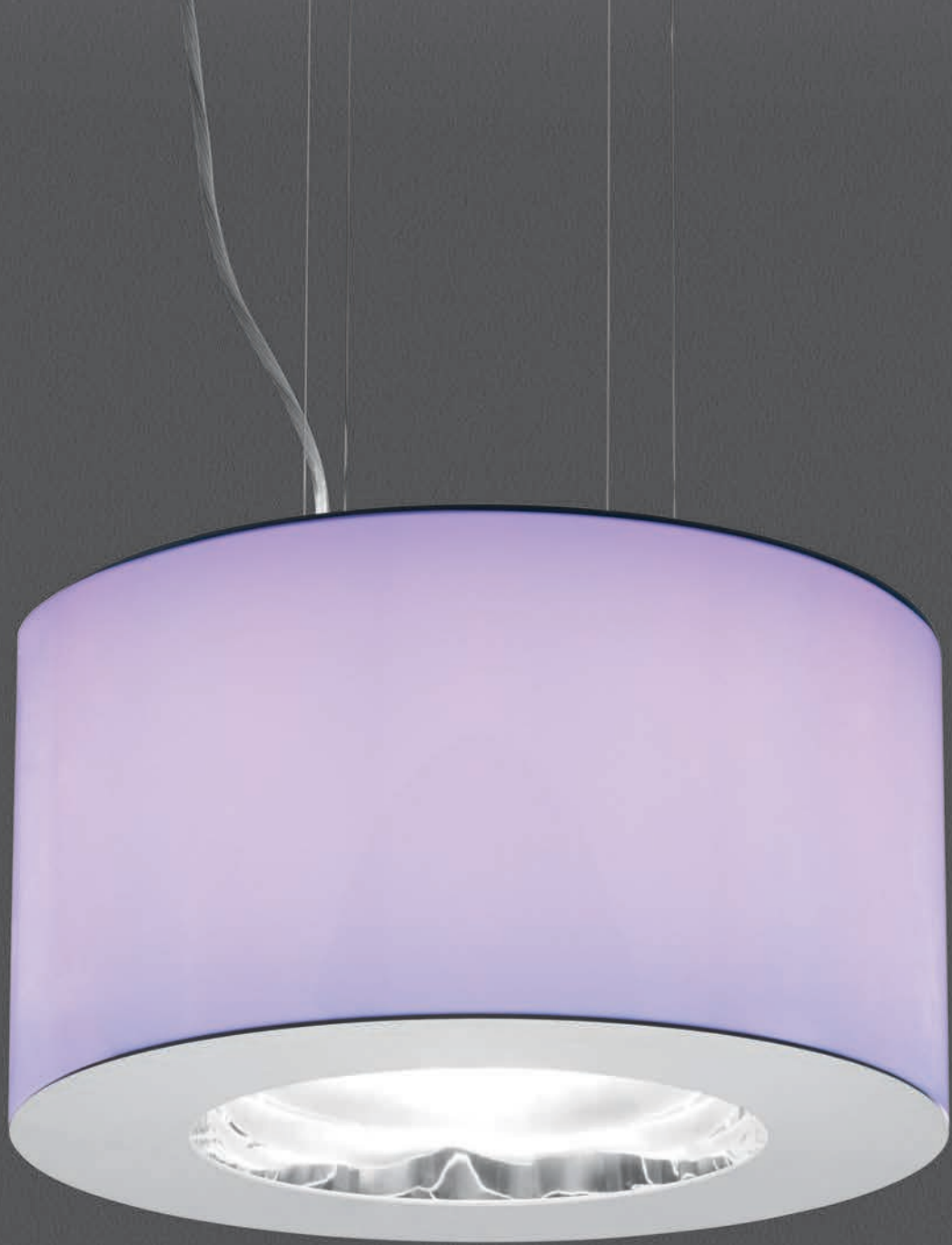



Serie di lampade a sospensione disponibili in diverse versioni.
3 dimensioni: Nur (ø diffusore 55 cm), Nur 1618 (ø diffusore 90 cm) e Nur Mini (ø diffusore 36 cm) **2 sorgenti luminose:** LED e alogena. **4 finiture:** alluminio anodizzato, antracite, gloss bianco e gloss nero.

Range of suspension lamps available in many versions.
3 sizes: Nur (diffuser ø 55 cm), Nur 1618 (diffuser ø 90 cm), and Nur Mini (diffuser ø 36 cm). **2 lighting sources:** LED and Halogen. **4 finishing:** Aluminium anodized, anthracite, white gloss and black gloss.

Série de suspensions disponibles dans de nombreuses versions.
3 tailles : Nur (diffuseur ø 55 cm), Nur 1618 (diffuseur ø 90 cm), et Nur Mini (diffuseur ø 36 cm). **2 sources lumineuses :** LED et Halogène. **4 finitions :** Aluminium anodisé, anthracite, blanc ou noir brillant.

Vielfältige Familie von Pendelleuchten.

3 Größen: Nur (Schirm ø55 cm), Nur 1618 (Schirm ø90 cm), Nur mini (Schirm ø36 cm). **2 Bestückungsvarianten:** LED, Halogen-. **4 Farben/Oberflächen:** Eloxiertem Aluminium, Anthrazit, Weiß glänzend und Schwarz glänzend.

Serie de lámparas de suspensión disponibles en distintas versiones.

3 dimensiones: Nur (ø difusor 55 cm), Nur 1618 (ø difusor 90 cm) y Nur Mini (ø difusor 36 cm). **2 fuentes de luz:** LED y Halógena. **4 acabados:** aluminio anodizado, antracita, gloss blanca y gloss negra.



528

LED

LED







Nur Mini



Nur



Nur 1618



LED

Halogen



Nur suspension
Nur 1618 suspension
Nur mini suspension

Ernesto Gismondi
2003

Materiali

Corpo lampada in alluminio, calotta superiore in vetro borosilicato sabbato.

Specificità

Disponibile come accessorio una cupola antiabbagliamento (Nur Halo) e per la versione Nur e Nur mini Halo anche un filtro colorato.

Materials

Aluminium body lamp; upper cap in borosilicate sanded glass.

Specification

Available accessories are anti-dazzle screen (Nur Halo) and coloured filter for Nur and Nur mini Halo.

Matériaux

Corps en aluminium; calotte supérieure en verre borosilicate sablé.

Spécificité

Un écran anti-éblouissant est disponible en option et, un écran anti-éblouissant (Nur Halo) et un filtre coloré sont disponibles pour les versions Nur et Nur mini Halo.

Materialien

Leuchtenkörper aus Aluminium; obere Kappe aus sandgestrahltem Borosilikatglas.

Spezifikation

Entblendungsschirm (Nur Halo) sowie Farbfilter für Nur Halo und Nur mini Halo als Zubehör erhältlich.

Materiales

Cuerpo de la lámpara en aluminio; campana superior en cristal borosilicado arenado.

Especificaciones

La cúpula antideslumbramiento (Nur Halo) es opcional y para las versiones Nur y Nur mini halógena un filtro de color.

Coloured filter
(Only for Nur Halo, Nur mini Halo)



Anti-dazzle screen
(Only for Nur Halo)



Light emission



Colours



Metal grey



Anthracite grey

Awards

2004 – Design Innovationen
Design Zentrum Nordrhein Westfalen
Reddot Design Award
Essen (Deutschland)



Photo by Oliviero Toscani, 2005

Nur 1618

Nur gloss suspension Nur gloss mini suspension

Ernesto Gismondi
2008

Materiali

Corpo lampada in alluminio verniciato; diffusore in policarbonato; calotta superiore in vetro borosilicato sabbato.

Specificità

Una finitura perfettamente liscia e lucida conferisce eleganza al classico modello Nur. Tutte le versioni sono chiuse da un diffusore nella parte inferiore.

Materials

Painted aluminium body lamp; diffuser in polycarbonate; upper cap in borosilicate sanded glass.

Specification

A perfectly smooth and polished finish adding that extra touch of elegance to the classic Nur model. All versions feature a screen on the bottom part of the shade.

Matériaux

Corps en aluminium verni ; diffuseur en polycarbonate ; calotte supérieure en verre borosilicate sablé.

Spécificité

Une nouvelle finition parfaitement lisse et brillante donne plus d'élégance au modèle Nur classique. Toutes les versions sont fermées par un diffuseur dans la partie inférieure.

Materialien

Körper aus lackiertem Aluminium; Schirm aus Polycarbonat; obere Abdeckung aus sandgestrahltem Borosilikatglas.

Spezifikation

Die neue Hochglanzpolitur verleiht dem Klassiker Nur eine besondere Eleganz. Alle Ausführungen sind mit einem an der Unterseite des Schirms angebrachten Diffusor versehen.

Materiales

Cuerpo de aluminio pintado, difusor de policarbonato, campana superior en cristal borosilicado arenado.

Especificaciones

Un nuevo acabado perfectamente liso y brillante confiere elegancia al clásico modelo Nur. Todas las versiones están cerradas por un difusor en la parte inferior.

Light emission



Colours



Polished
black



Polished
white



Nur gloss

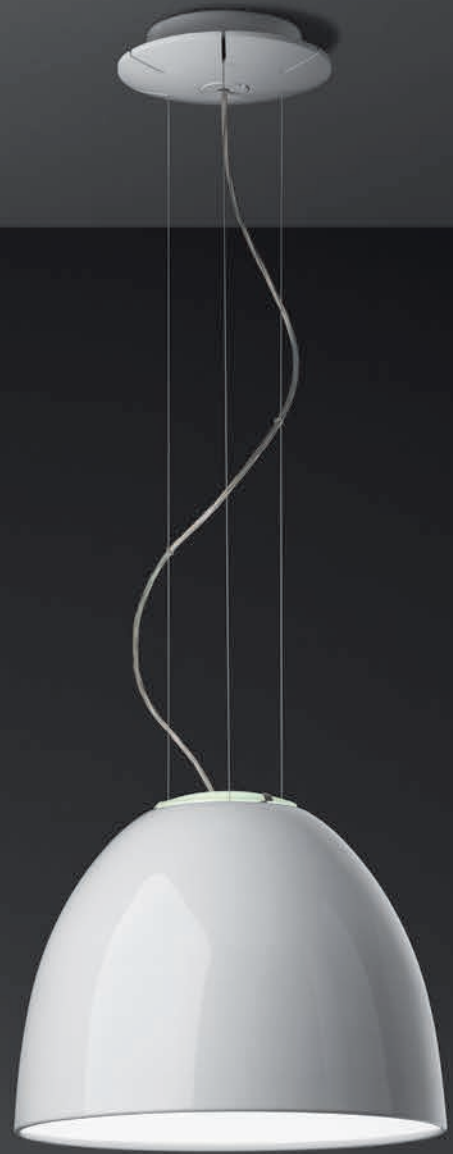

Nur gloss mini

Mercury Mercury mini

Ross Lovegrove
2007

Materiali

Corpi luminosi in alluminio pressofuso; corpi riflettenti in materiale termoplastico stampato ad iniezione con finitura metallizzata; riflettore in acciaio inox.

Materials

Die-cast aluminium lighting units; reflective units made of injection-moulded thermoplastic material with metallic finish; stainless steel reflector.

Matériaux

Corps lumineux en aluminium moulé sous pression. Galets réfléchissants en matériau thermoplastique finition métallisée. Réflecteur en acier inoxydable.

Materialien

Leuchtenkörper aus druckgegossenem Aluminium; reflektierende Körper aus Spritzguss-Thermoplast mit Metallic-Oberfläche; Reflektor aus Edelstahl.

Materialies

Cuerpos luminosos en aluminio fundido a presión; cuerpos reflectantes en material termoplástico moldeado por inyección, con acabado metalizado; reflector en acero inoxidable.

Awards

Mercury:

2008 – Reddot Design Award
“Best of the Best”, Essen (Deutschland)
2008 – Good Design Award
The Chicago Atheneum, Chicago (US)

Light emission



Colours



Reflector:
Satinated



Units:
Mirror



Mercury mini

Materiali

Corpo lampada-riflettore in materiale termoplastico.
Corpi illuminanti in alluminio pressofuso.

Materials

Body lamp-reflector made of thermoplastic material;
die-cast aluminium lighting units.

Matériaux

Corps-réfecteur en matériau thermoplastique ;
corps lumineux en aluminium moulé sous pression.

Materialien

Leuchtenkopf aus thermoplastischem Material;
Leuchtenkörper aus druckgegossenem Aluminium.

Materiales

Cuerpo de la lámpara-reflector en material termoplástico.
Cuerpo luminoso en aluminio fundido.

Light emission



Colours



Mirror

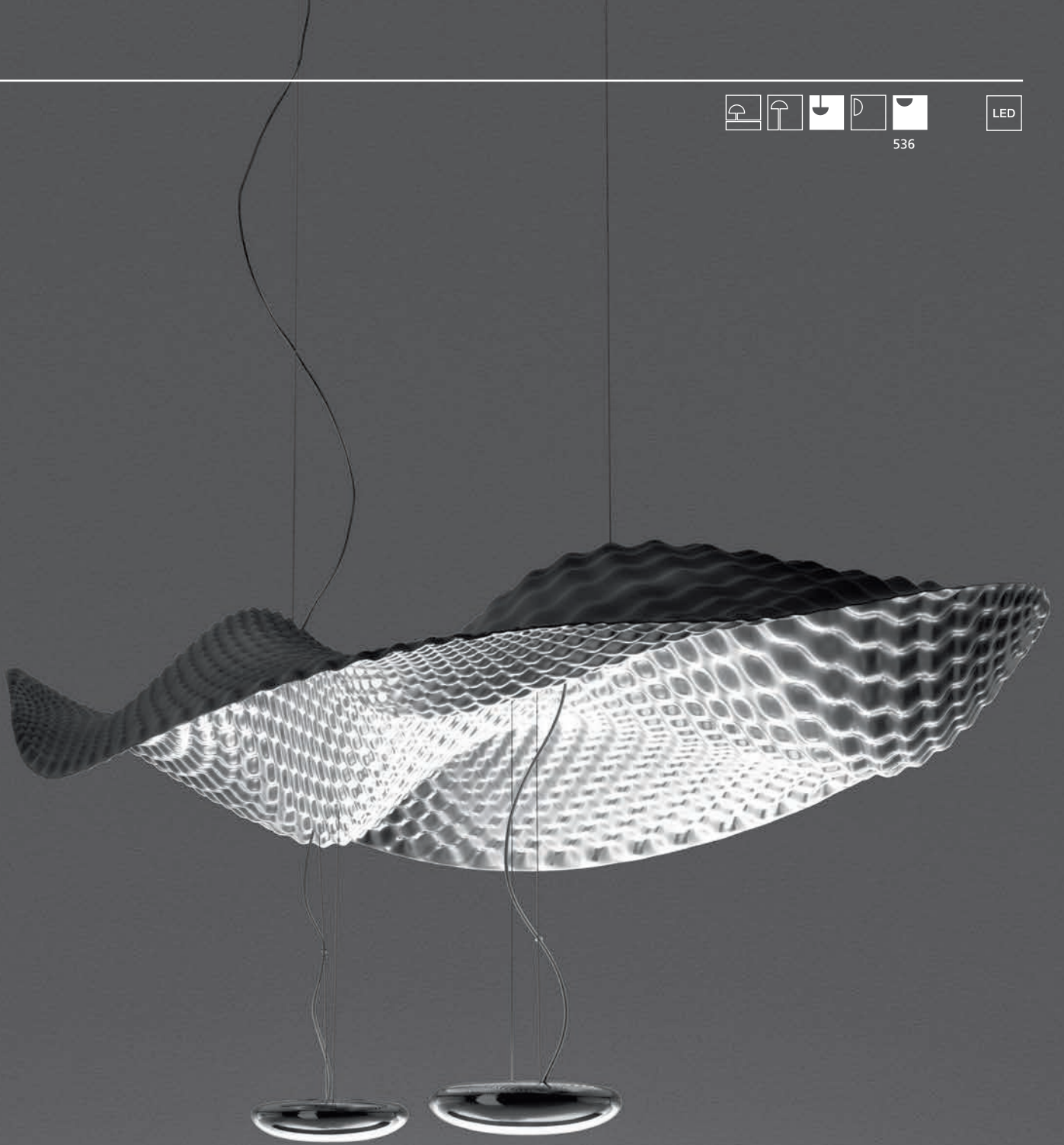

Attraverso il minimo della presenza fisica determina un effetto sorprendente. Le sorgenti LED si concentrano in aree contrapposte per una emissione che si distribuisce nello spazio a 360° in modo non uniforme ma controllato.

Materiali

Alluminio verniciato

Specificità:

E' possibile una gestione indipendente delle emissioni diretta ed indiretta.

With a minimal physical presence, it produces a surprising effect. The LED sources are located opposite to each other for an emission that is distributed throughout space in an uneven, yet controlled way.

Materials

Painted aluminum

Specification

It allows independent management of the direct and indirect emission.

Par le minimum de sa présence physique, elle produit un effet surprenant. Les sources LED se concentrent dans des espaces opposés, pour une émission qui se distribue dans l'espace à 360° de manière non uniforme mais contrôlée.

Matériaux

Aluminium laqué

Spécificité

Une gestion indépendante des émissions directe et indirecte est possible.

Durch das Minimum an physischer Präsenz wird eine erstaunliche Wirkung erzeugt. Die LED-Quellen sind in gegenüberliegenden Bereichen konzentriert für eine Lichtemission, die sich zu 360° auf ungleichmäßige, aber kontrollierte Weise im Raum verteilt.

Materialien

Lackiertem Aluminium.

Spezifikation

Unabhängig von direkter und indirekter Lichtemission ist eine Steuerung möglich.

A través de una presencia física mínima, determina un efecto sorprendente. Las fuentes LED se concentran en áreas contrapuestas para una emisión que se distribuye en el espacio en 360° de manera no uniforme sino controlado.

Materiales

Aluminio pintado.

Especificaciones

Es posible una gestión independiente de las emisiones directa e indirecta.

Light emission**Colours**

White



Black



Red



Gold
aluminium





Direct emission

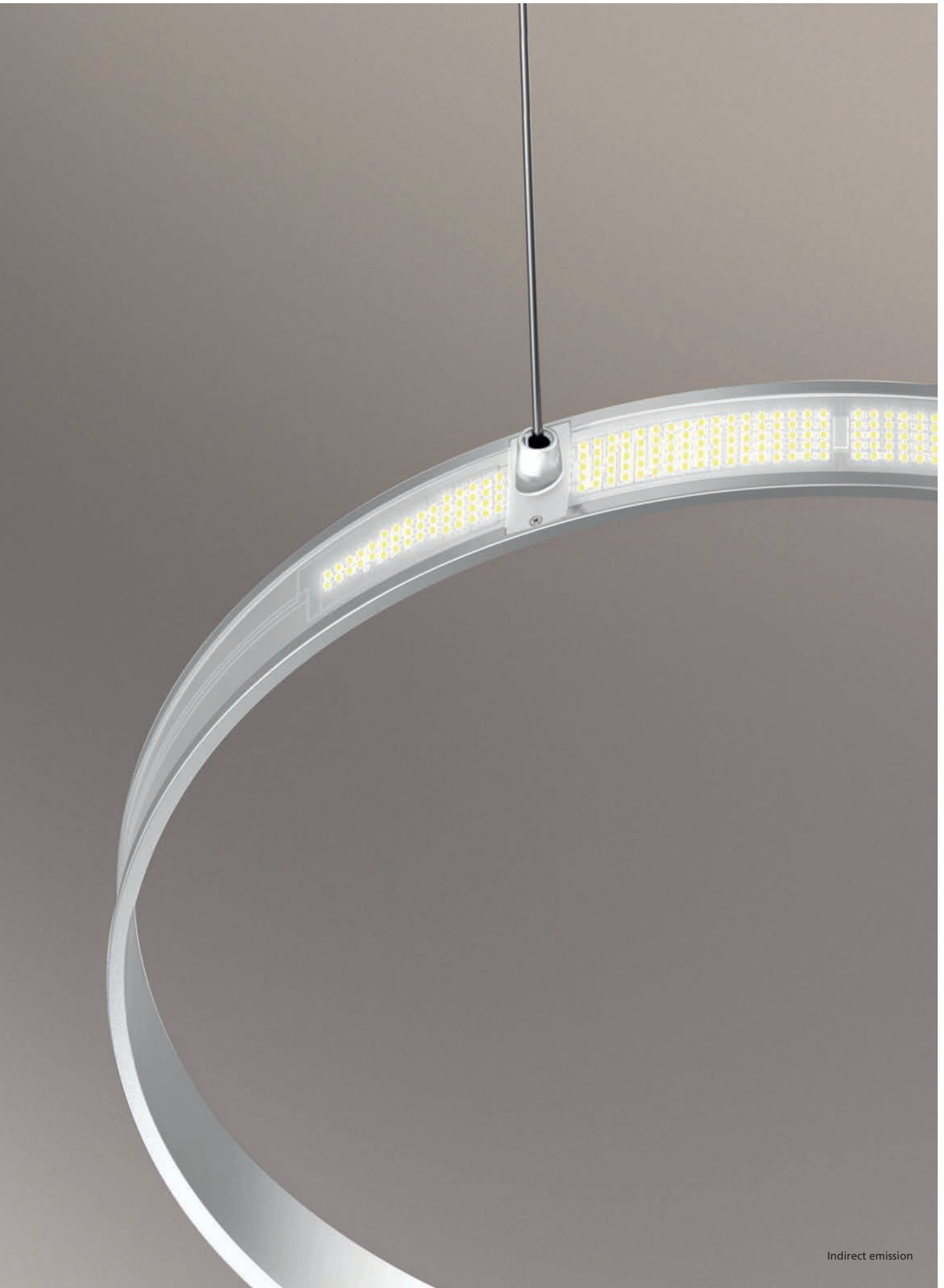

Indirect emission

Eclittica 20

Carlotta de Bevilacqua
2013

Attraverso il minimo della presenza fisica determina un effetto sorprendente.

Materiali

Alluminio verniciato e policarbonato

With a minimal physical presence, it produces a surprising effect through the light and shadow contrasts it creates.

Materials

Painted aluminum and polycarbonate.

Par le minimum de sa présence physique, elle produit un effet surprenant grâce aux jeux de lumières et d'ombres qu'elle crée.

Matériaux

Aluminium peint et polycarbonate

Durch das Minimum an physischer Präsenz löst sie aufgrund der Spiele mit Licht und erzeugenden Schatten eine erstaunliche Wirkung aus.

Materialien

Lackiertem Aluminium und Polycarbonat.

A través de una presencia física mínima, determina un efecto sorprendente gracias a los juegos de luces y sombras que crea.

Materiales

Aluminio pintado y policarbonato.



Light emission



Colours





Decomposé light suspension

Atelier Oi
2016

Gioca sulla destrutturazione del profilo di base, la luce proiettata attraverso gli anelli in equilibrio disegna sottili ombre nella definizione di una perfetta qualità di luce nello spazio.

Materiali

Alluminio anodizzato.

Specificità

Gli anelli possono essere direzionati verso l'alto o verso il basso semplicemente invertendo l'orientamento del corpo durante l'installazione, l'emissione è diretta e indiretta.

Featuring a deconstructed base profile, the light projected through the balanced rings designs subtle shadows while defining a perfect quality of light in space.

Materials

Anodized aluminum.

Specification

The rings can be adjusted upwards or downwards by simply reversing the body's direction upon installation. Emission is both direct and indirect.

Elle joue sur la déstructuration du profil de base ; la lumière projetée à travers les anneaux en équilibre dessine de fines ombres pour la définition d'une qualité parfaite de la lumière dans l'espace.

Matériaux

Aluminium anodisé.

Spécificité

Les anneaux peuvent être dirigés vers le haut ou vers le bas, simplement en invertissant l'orientation du corps pendant l'installation ; l'émission est directe et indirecte.

Sie spielt mit der Destrukturierung vom Basisprofil.

Das durch die ausgeglichenen Ringe projizierte Licht zeichnet dünne Schatten in der Definition einer perfekten Lichtqualität in den Raum.

Materialien

Aluminium eloxiert.

Spezifikation

Die Ringe können nach oben oder unten gerichtet werden, indem einfach die Ausrichtung des Körpers bei der Installation umgekehrt wird. Die Lichtemission ist direkt und indirekt.

Juega con la desestructuración del perfil de base, la luz proyectada a través de los anillos en equilibrio diseña sombras finas en la definición de una calidad perfecta de la luz en el espacio.

Materiales

Aluminio anodizado.

Especificaciones

Los anillos se pueden dirigir hacia arriba o abajo simplemente invirtiendo la orientación del cuerpo durante la instalación, la emisión es directa e indirecta.

Light emission

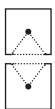

Colour

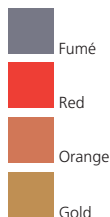



Miyako 30, 55
Miyako chandelier

Studio 63
2009

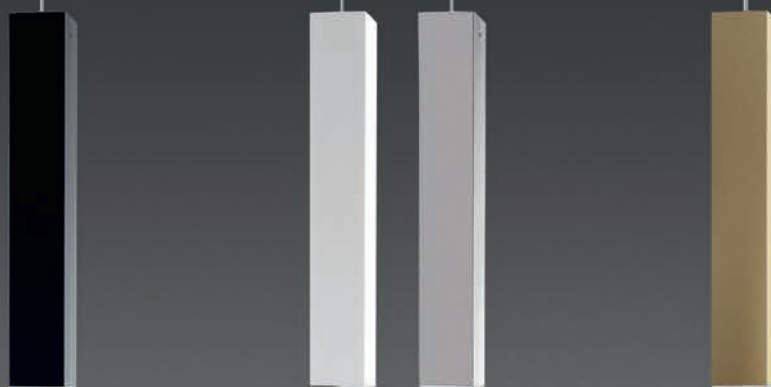

Light emission



Colours



White

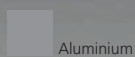

Aluminium

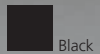

Black

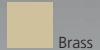

Brass



Red



Orange

Miyako è un sistema completo e diversificato per tipologie, performance di luce e varietà di colori disponibili, capace di creare scenografiche composizioni o di inserirsi con discrezione in qualsiasi ambiente garantendo ottime prestazioni luminose. Miyako può avere due corpi di lunghezza differente, 30 o 55 cm. La versione chandelier è composta da 8 elementi Miyako 55.

Materiali

Alluminio spazzolato, alluminio verniciato, metacrilato.

Miyako is a complete system with different solutions according to light performance and type, and to the various colours available: it can create spectacular effects or integrate gently in any environment, guaranteeing excellent light performance. Miyako is available in two different body sizes (30 or 55 cm of length). The chandelier version consists of 8 elements Miyako 55.

Materials

Brushed aluminum, painted aluminium, methacrylate.

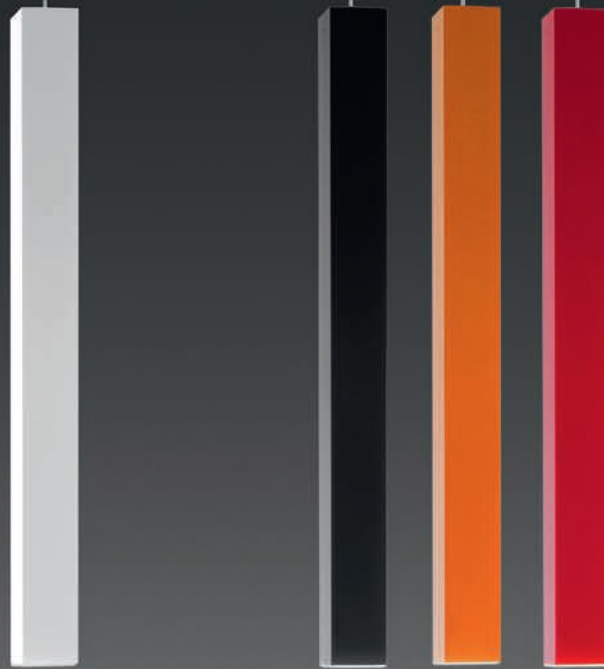

Miyako est un système complet et diversifié par typologies, performances de lumière et variétés de couleurs disponibles, en mesure de créer des compositions scénographiques ou de s'insérer avec discrétion dans n'importe quel milieu en garantissant de très bonnes performances de lumière. Miyako peut avoir deux corps de longueur différente, 30 ou 55 cm. La version chandelier est composé de 8 éléments Miyako 55.

Matériaux

Aluminium brossé, aluminium peint, methacrilate.

Miyako ist ein vollständiges System, dessen Ausführung sich durch Aufbau, Lichtleistung und verfügbare Farbvielfalt unterscheidet. Es schafft bühnenhafte Kompositionen oder fügt sich diskret in jede Umgebung ein, wobei es ausgezeichnete beleuchtungstechnische Leistungen gewährleistet. Miyako kann zwei verschieden lange Körper haben: 30 oder 55 cm. Die Clusterversion besteht aus 8 Miyako 55 Elementen.

Materialien

Gebürstetem Aluminium, lackiertes Aluminium, Metacrylat.

Miyako es un sistema completo con diferentes soluciones según el rendimiento y el tipo de luz, y a los diversos colores disponibles: capaz de crear efectos espectaculares o integrarse sutilmente en cualquier ambiente, garantizando óptimos rendimientos lumínicos. Miyako está disponible en dos tamaños distintos (30 o 55 cm de longitud). La versión chandelier se compone de 8 elementos de Miyako 55.

Materiales

Aluminio cepillado, aluminio pintado, metacrilato.



Miyako chandelier



Miyako chandelier

Float circolare

James Irvine
2000

Materiali

Struttura in alluminio verniciato; diffusore inferiore in metacrilato opalino; diffusore superiore in policarbonato trasparente.

Specificità

È possibile applicare un filtro blu o topazio all'emissione indiretta.

Materials

Structure in painted aluminium, lower diffuser in opaline methacrylate, upper diffuser in transparent polycarbonate.

Specification

Application of a coloured filter, blue or topaz, to the indirect light emission.

Matériaux

Structure en aluminium verni, diffuseur inférieur en méthacrylate opalin, diffuseur supérieur en polycarbonate transparent.

Spécificité

Un filtre coloré (bleu ou topaze) peut être ajouté, à l'émission indirecte.

Materialien

Struktur aus lackiertem Aluminium; unterer Schirm aus opalem Metacrylat; oberer Schirm aus transparentem Polycarbonat.

Spezifikation

Für die Versionen Float circolare ist der Einsatz eines blauen oder goldgelben Farbfilters möglich.

Materiales

Estructura de aluminio pintado; difusor inferior de metacrilato opalino, difusor superior en metacrilato transparente.

Especificaciones

Es posible aplicar un filtro azul o topacio para la emisión de luz indirecta.

Awards

Float circolare

2001 – Compasso d'Oro / A.D.I. – Segnalazione
Milano (Italia)

Light emission



Colours



White

Coloured filters





514



Materiali

Rosone in resina termoplastica; corpo in alluminio verniciato; diffusore inferiore in metacrilato opalino.

Specificità

Disponibile in diverse lunghezze a seconda della sorgente impiegata. I cavetti di sospensione svolgono anche funzione di alimentazione.

Materials

Thermoplastic resin ceiling rose; painted aluminium body; opal methacrylate lower diffuser.

Specification

Available in different lengths according to the power of the light source. The suspension cables are also feed cables.

Matériaux

Rosace en résine thermoplastique ; corps en aluminium verni ; diffuseur inférieur en méthacrylate opalin.

Spécificité

Disponibile en différentes longueurs selon la puissance de la source lumineuse. Les 4 câbles servent également de câbles d'alimentation.

Materialien

Rosette aus Kunststoff; Körper aus lackiertem Aluminium; unterer Schirm aus opalem Methacrylat.

Spezifikation

Erhältlich in verschiedenen Größen (in Abhängigkeit des eingesetzten Leuchtmittels) erhältlich. Die Seilzüge dienen als Aufhängung und Stromversorgung.

Materiales

Rosetón en resina termoplástica; cuerpo en aluminio pintado; difusor inferior en metacrilato opalino.

Especificaciones

Disponibile en longitudes diferentes según la potencia de la fuente luminosa. Los cables desarrollan también la función de alimentación.

Light emission



Colours



White



Silver grey

Awards

2002 – Prix “L’Observateur du Design 2002”
“Etoile 2002” – Paris (France)

2002 – Design Innovationen – Design
Zentrum Nordrhein Westfalen
Reddot Design Award
Essen (Deutschland)

2002 – iF Product Design Award
Hannover (Deutschland)

2002 – Compasso d’Oro / A.D.I.
– Selezione, Milano (Italia)

2003 – Intel Design
Categoria design “Augusto Morello”
III edizione – Milano (Italia)



LED

414
416

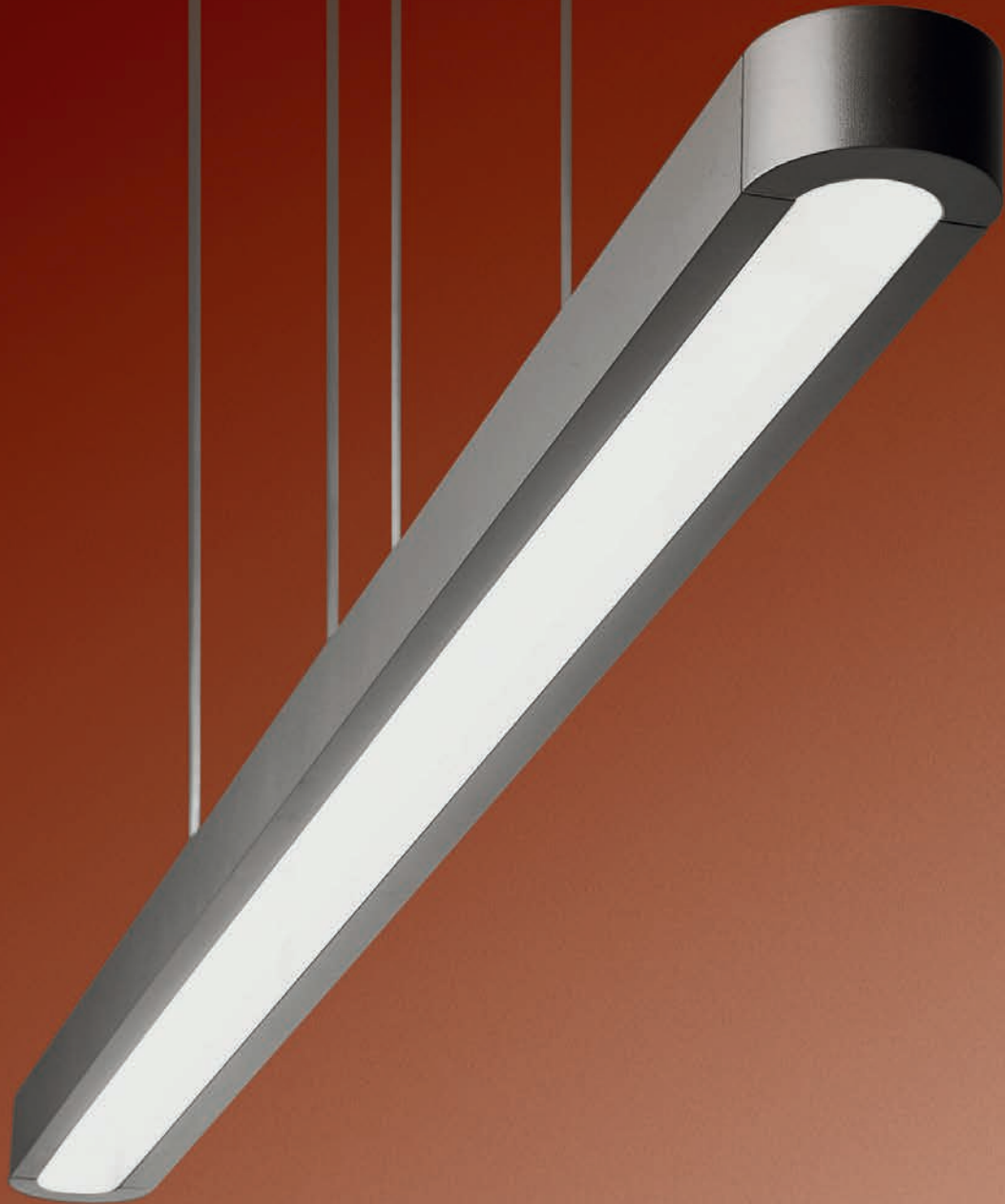





174



434

**Materiali**

Corpo lampada in alluminio pressofuso verniciato.

Specificità

I cavetti di sospensione fungono anche da alimentazione.

Materials

Body lamp in painted die-cast aluminium.

Specification

The suspension cables are also feed cables.

Matériaux

Corps en aluminium moulé sous pression peint.

Spécificité

Les câbles de suspension servent également de câbles d'alimentation.

Materialien

Leuchtenkörper aus druckgegossenem, lackiertem Aluminium.

Spezifikation

Die Aufhängung der Leuchte dient gleichzeitig als Netzkabel zur Stromversorgung.

Materiales

Cuerpo de la lámpara en aluminio fundido a presión y pintado.

Especificaciones

Los cables de suspensión funcionan también de alimentación.

Light emission**Colours**

White

Tolomeo due bracci alluminio suspension

Michele De Lucchi
Giancarlo Fassina
1996

Materiali

Struttura a bracci mobili in alluminio lucidato; diffusore in alluminio anodizzato opaco; snodi in alluminio brillantato.

Specificità

Tige rigida adattabile in funzione dell'altezza del soffitto. Sistema di equilibratura a molle.

Materials

Cantilevered arms in polished aluminium; diffuser in matt anodised aluminium; joints in polished aluminium.

Specification

Rigid rod adjustable for different ceiling heights. System of spring balancing.

Matériaux

Structure à bras articulés en aluminium poli ; diffuseur en aluminium anodisé opaque, rotules en aluminium brillant.

Spécificité

Tige rigide, adaptable aux différentes hauteurs de plafond. Système d'équilibrage à ressorts.

Materialien

Ausrichtbare Arme aus glänzendem Aluminium; Kopf aus matt eloxiertem Aluminium; Gelenke aus poliertem Aluminium.

Spezifikation

Höhenverstellbarer Stab. Mit Federausgleichsystem.

Materiales

Estructura con brazos móviles de aluminio pulido; difusor en aluminio anodizado opaco; articulaciones de aluminio pulido.

Especificaciones

La varilla rígida se regula con arreglo a la altura del techo. Sistema de equilibrado a muelles.

Light emission



Colours



Rod and diffusers:
Metal grey



Arms:
Mirror





Tolomeo due bracci pergamena suspension

Michele De Lucchi
Giancarlo Fassina
2005

Materiali

Struttura a bracci mobili in alluminio lucidato; diffusori in carta pergamena o in raso di seta supportato da materiale plastico; snodi in alluminio brillantato.

Specificità

I diffusori nel normale utilizzo si dispongono verticalmente, indipendentemente dall'angolazione del braccio. Tige rigida adattabile in funzione dell'altezza del soffitto. Sistema di equilibratura a molle.

Materials

Cantilevered arms in polished aluminium; diffuser in parchment paper or in silk satin fabric on a plastic frame, joints in polished aluminium.

Specification

The diffusers, available in four sizes, normally used, remains vertical regardless of the angle of the arm. Rigid rod adjustable for different ceiling heights. System of spring balancing.

Matériaux

Structure à bras articulés en aluminium poli ; diffuseur en papier parchemin ou en polycarbonate recouvert de satin de soie gris; articulations en aluminium brillant.

Spécificité

Les diffuseurs, disponibles en quatre tailles, dans le cadre d'une utilisation normale, les diffuseurs se placent verticalement, indépendamment de la position du bras. Tige rigide, adaptable aux différentes hauteurs de plafond. Système d'équilibrage à ressorts.

Materialien

Ausrichtbare Arme aus glänzendem Aluminium; Schirm aus mit Kunststoff stabilisiertem Pergamentpapier oder Seidensatin; Gelenke aus poliertem Aluminium.

Spezifikationen

Bei normaler Anwendung befinden sich die Schirme (erhältlich in vier Größen) in einer vertikalen Position, unabhängig von der Ausrichtung des Armes. Höhenverstellbarer Stab. Federausgleichsystem.

Materiales

Estructura con brazos móviles de aluminio pulido; difusor en pergamino o en raso seda reforzado con plástico; articulaciones de aluminio pulido.

Especificaciones

Los difusores, disponibles en cuatro tamaños, en su uso normal, se disponen verticalmente, independientemente de la angulación del brazo. La varilla rígida se regula con arreglo a la altura del techo. Sistema de equilibrado a muelles.

Light emission



Colours

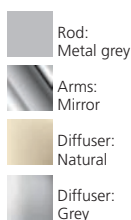



Tolomeo decentrata suspension

Michele De Lucchi
Giancarlo Fassina
1996

Materiali

Struttura a bracci mobili in alluminio lucidato; snodi in alluminio brillantato; diffusori in alluminio opaco o carta pergamena o seta di raso.

Specificità

Disponibile con diffusori di diverse forme, dimensioni e materiali. Sistema di equilibratura a molle.

Materials

Cantilevered arms in polished aluminium; joints in polished aluminium; diffuser in matt aluminium or in parchment paper or silk satin fabric.

Specification

Available with different shapes, sizes and materials diffusers. System of spring balancing.

Matériaux

Structure à bras articulés en aluminium poli ; articulations en aluminium brillant ; diffuseur en aluminium opaque en papier parchemin, ou en satin de soie gris.

Spécificité

Disponible avec diffuseurs de formes, de tailles et de matériaux différents. Système d'équilibrage à ressorts.

Materialien

Ausrichtbare Arme aus glänzendem Aluminium; Gelenke aus poliertem Aluminium; Schirm aus mattem Aluminium, Pergamentpapier, Seidensatin.

Spezifikation

Erhältlich mit verschiedenen Schirmen in unterschiedlichen Größen und aus verschiedenen Materialien.

Materiales

Estructura con brazos móviles de aluminio pulido; articulaciones de aluminio pulido; difusores de aluminio opaco, en pergamino o en raso seda.

Especificaciones

Está disponible con difusores de formas, tamaños y materiales diferentes. Sistema de equilibrado a muelles.

Light emission



Colours



Structure:
Mirror



Diffuser:
Metal Grey



Diffuser:
Natural



Diffusers:
Grey

Awards

2001 – iF Product Design Award
Hannover (Deutschland)

2001 – Focus Mobilität Internationaler
Designpreis – Baden Württemberg
Stuttgart (Deutschland)

						LED
44	196			456		
60	198			458		
				460		
				462		

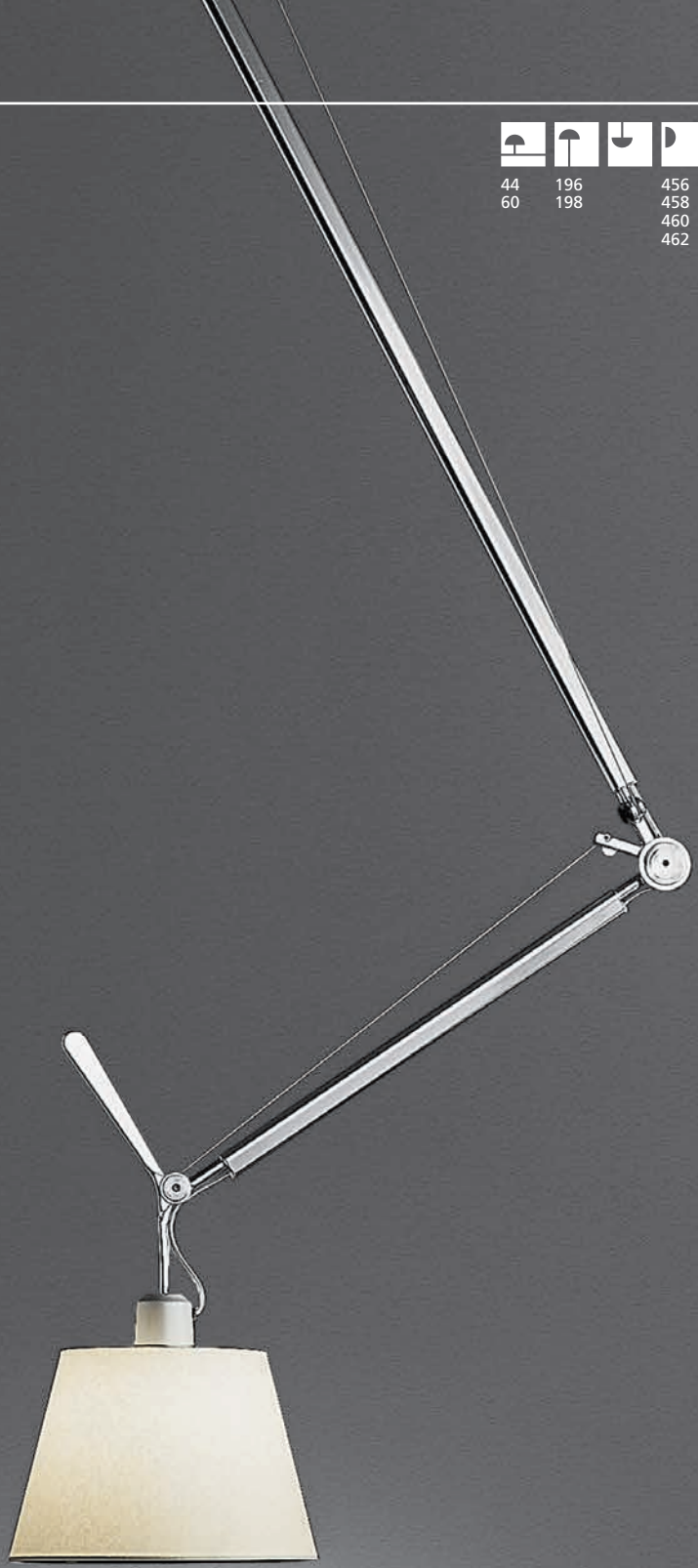



Silk satin fabric diffuser



Alluminium diffuser

Parchment paper diffuser

Tolomeo mega suspension

Michele De Lucchi
Giancarlo Fassina
2007

Materiali

Struttura in alluminio e metacrilato trasparente stampato ad iniezione; diffusore in carta pergamena, in raso di seta o in tessuto nero supportato da materiale plastico.

Materials

Aluminium and transparent injection-moulded methacrylate structure; diffuser in parchment paper, in silk satin or in black fabric on a plastic frame.

Matériaux

Structure en aluminium et en méthacrylate transparent ; diffuseur en papier parchemin, en polycarbonate ou en tissu noir recouvert de satin de soie gris ou noir.

Materialien

Struktur aus Aluminium und transparentem Metacrylat-Spritzguss; Schirm aus mit Kunststoff stabilisiertem Pergamentpapier, Seidensatin oder Gewebe schwarz Gelenke.

Materiales

Estructura en aluminio y metacrilato transparente moldeado por inyección; difusor en pergamino, en raso seda o en tejido negro reforzado con plástico.

Light emission



Colours



Awards

2001 – iF Product Design Award
Hannover (Deutschland)

2001 – Focus Mobilität Internationaler
Designpreis – Baden Württemberg
Stuttgart (Deutschland)



Tolomeo lampione hook outdoor
Tolomeo paralume hook outdoor
Tolomeo lampione suspension outdoor
Tolomeo paralume suspension outdoor

Michele De Lucchi
Giancarlo Fassina
2016

Materiali

Il diffusore di Tolomeo paralume è rivestito in tessuto Thuaia di Paola Lenti, un materiale plastico che, con l'aspetto di una iuta naturale, garantisce resistenza e lavabilità. Materiali e finiture adatte per esterni.

Specificità

Tolomeo lampione suspension outdoor è progettata per un utilizzo anche senza diffusore, lasciando in vista l'elemento diffusore opalino di copertura della sorgente che garantisce la protezione IP65: assume così l'aspetto che ricorda i tradizionali lampioni.

Materials

The diffuser of Tolomeo paralume is coated with Thuaia fabric by Paola Lenti, a plastic material that looks like natural jute but ensures high resistance and washability. Materials and finishes are fit for outdoor use.

Specification

Tolomeo lampione suspension outdoor is designed for use without a diffuser, with the exposed opal glass diffusing unit covering the source and ensuring IP65 protection: in this version it looks like a traditional lamppost.

Matériaux

Le diffuseur de Tolomeo paralume est revêtu d'un tissu Thuaia de Paola Lenti, matière plastique qui, ayant l'aspect d'une jute naturelle, garantit résistance et lavabilité. Matières et finitions adaptées à l'extérieur.

Spécificité

Tolomeo lampione suspension outdoor est conçu pour être utilisé même sans le paralume, laissant en vue l'élément diffuseur opale qui couvre la source et assure la protection IP65. Cela rappelle les lampadaires traditionnels.

Light emission



Colours



Mirror



White



Black

Materialien

Der Diffusor vom Lampenschirm Tolomeo ist von Paola Lenti mit Thuaia-Stoff ausgekleidet, einem Kunststoff, der wie natürliche Jute aussieht, aber Haltbarkeit und Waschbarkeit gewährleistet. Materialien und Oberflächen sind für den Outdoor-Einsatz geeignet.

Spezifikation

Tolomeo lampione suspension outdoor ist so konzipiert, auch ohne den Lautsprecher zu verwenden, einen Blick auf die Quelle der Abdeckung Opal Diffusorelement verlassen, die die Schutzart IP65 gewährleistet. Das hat die Form erinnert an die traditionellen Straßenlampen.

Materiales

El difusor de Tolomeo pantalla está revestido en tejido Thuaia de Paola Lenti, un material plástico que, con el aspecto de un yute natural, garantiza resistencia y lavabilidad. Materiales y acabados adecuados para uso en exteriores.

Especificaciones

Tolomeo lampione suspension outdoor está diseñado para ser utilizado incluso sin el altavoz, dejando una vista de la fuente de cubierta opal elemento difusor que asegura la protección IP65: esto toma la forma que recuerda a las lámparas tradicionales de la calle.



Tolomeo lampione hook



202

LED



Tolomeo paralume hook



Tolomeo paralume suspension outdoor



Tolomeo lampione suspension outdoor

Incalmo Incalmo 214

Carlotta de Bevilacqua
2015

Dall'idea iniziale di Incipit, una macchina ottica, termica, tecnologica alla volontà di recuperare allo stesso tempo una dimensione umana, artigianale, che contempla la bellezza dell'imperfezione grazie alla rivisitazione della tradizione del vetro soffiato.

From the early idea for Incipit – an optical, thermal, technological device – to the wish to restore a human, craft dimension, encompassing the beauty of imperfection with a renewed approach to the blown-glass tradition.

A partir de l'idée initiale d'Incipit, une machine optique, thermique, technologique ayant la volonté de récupérer en même temps une dimension humaine, artisanale contemplant la beauté de l'imperfection grâce au retour de la tradition du verre soufflé.

Bei der ersten Idee von Incipit, einer optischen, thermischen und technologischen Beleuchtung, wird eine menschliche und handwerkliche Dimension gestaltet, die durch eine Neuinterpretation der Tradition des mundgeblasenen Glases die Schönheit der Unvollkommenheit kontemplant.





De la idea inicial de Incipit, una máquina óptica, térmica, tecnológica a la voluntad de recuperar al mismo tiempo una dimensión humana, artesanal, que contempla la belleza de la imperfección gracias a la reinterpretación de la tradición del vidrio soplado.



Light emission



Colours

	Structure: Mirror
	Structure: White
	Diffuser: White Incalmo
	Diffuser: Grey Incalmo





Materiali

Struttura in alluminio, diffusore in vetro soffiato con tecnica a Incalmo.

Specificità

Incalmo cita una tecnica ideata a Murano nel XVI secolo grazie alla quale è possibile ottenere vetri soffiati caratterizzati da due o più zone di colore diverso. L'alternanza di bande orizzontali trasparenti e di colore bianco o grigio ne trasforma il corpo decorativo in un elemento di controllo e diffusione dell'emissione luminosa. Disponibile in due grandezze.

Materials

Aluminium frame, blown-glass diffuser based on the "incalmo" technique.

Specification

Incalmo refers to a technique introduced in the 16th century in Murano, which allows to obtain blown glass with two or more parts of different colours. The alternating clear and white or grey horizontal bands transform the ornamental body into a control unit for lighting emission. Available in two sizes.

Materiaux

Structure en aluminium, diffuseur en verre soufflé, technique 'Incalmo'.

Spécificité

Incalmo cite une technique conçue à Murano au XVIe siècle grâce à laquelle on peut obtenir des verres soufflés caractérisés par deux ou plusieurs zones d'une couleur différente. L'alternance de bandes horizontales transparentes et de couleur blanche ou grise transforme le corps décoratif en un élément de contrôle et diffusion de l'émission lumineuse. Disponible en deux dimensions.

Materialien

Aluminiumstruktur, Diffusor aus geblasenem Glas mit Incalmo-Technik.

Spezifikation

Incalmo zitiert eine Technik, die im sechzehnten Jahrhundert in Murano entwickelt wurde, um geblasenes Glas in zwei oder mehr Farben zu erhalten. Der Wechsel von transparenten Querstreifen und der Farbe Weiß oder Grau verwandelt den dekorativen Leuchtenkörper in ein Steuerelement zur Verteilung des Lichts. In zwei Größen erhältlich.

Materiales

Estructura de aluminio, difusor de vidrio soplado con técnica de Incalmo.

Especificaciones

Incalmo menciona una técnica ideada en Murano en el siglo XVI con la que es posible obtener vidrios soplados caracterizados por dos o más zonas de color diferente. La alternancia de franjas horizontales transparentes y de color blanco o gris convierte el cuerpo decorativo en un elemento de control y difusión de la emisión luminosa. Disponible en dos tamaños.



Light emission



Colours



Structure:
Mirror



Structure:
White



Diffuser:
White Zanfirico



Diffuser:
Blue Zanfirico

Rappresenta una reinterpretazione delle tecniche di lavorazione tradizionale del vetro non solo nelle finiture ma anche nella forma che riprende nelle proporzioni la classica geometria del vaso veronese, tipica della produzione veneziana del vetro.

Materiali

Struttura in alluminio, diffusore di vetro soffiato con tecnica "Zanfirico".

Specificità

Il diffusore in vetro soffiato è realizzato con la tecnica dello Zanfirico, variante della filigrana con fili intrecciati sviluppatasi nel Rinascimento.

A new interpretation of traditional glass processing techniques, both in the finishes and in the shape, whose proportions are based on the classical geometry of Verona pots, typical of Venetian glass production.

Materials

Aluminium frame, glass diffuser blown with the "Zanfirico" technique.

Specification

The blown-glass diffuser is obtained with the Zanfirico technique, a variation of filigree, with intertwined threads, developed during the Renaissance age.

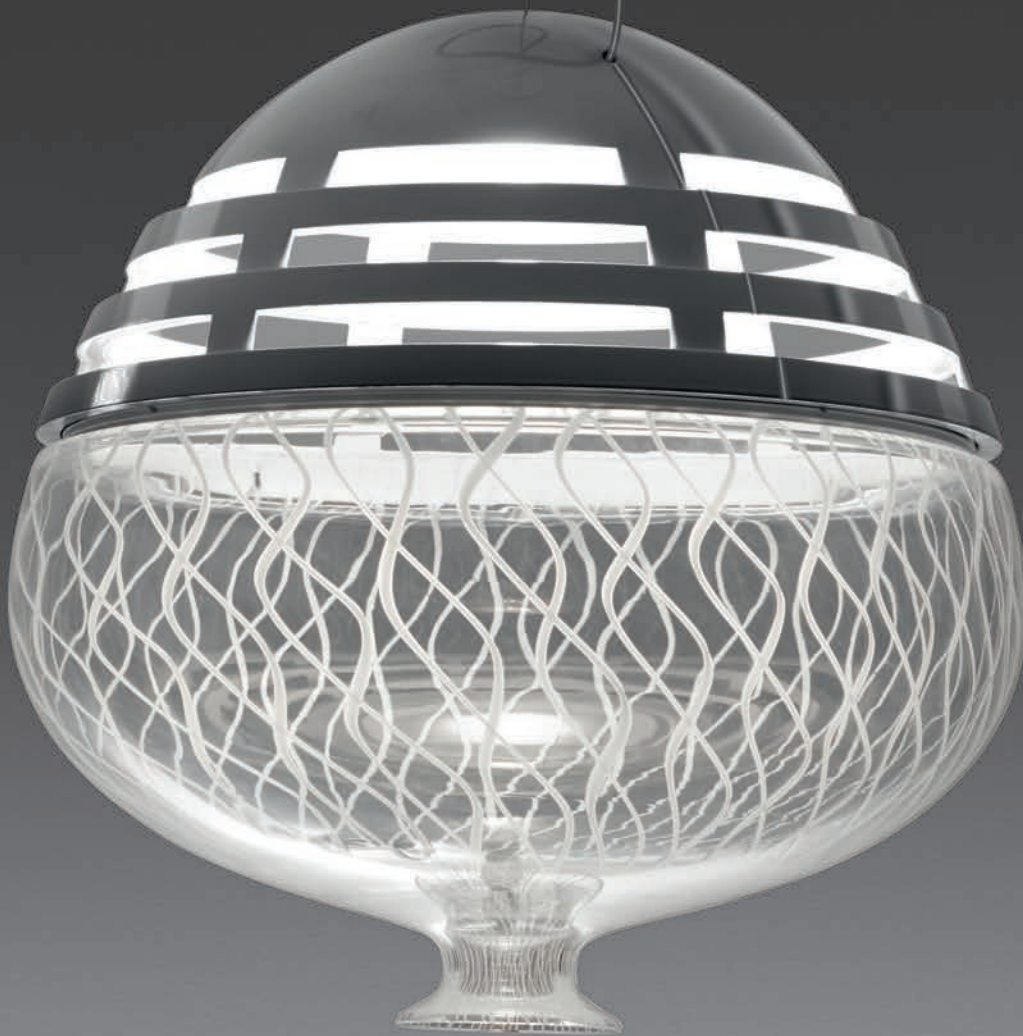

Elle représente une réinterprétation des techniques de travail traditionnel du verre non seulement dans les finitions mais aussi dans la forme, qui reprend dans ses proportions la géométrie classique du vase 'veronese', typique de la production vénitienne du verre.

Matériaux

Structure en aluminium, diffuseur en verre soufflé par la technique "Zanfirico".

Spécificité

Le diffuseur en verre soufflé est réalisé selon la technique Zanfirico, variante de la filigrane, avec des fils tressés, qui s'était répandue à la Renaissance.

Ist eine Neuinterpretation der traditionellen Bearbeitungstechniken des Glases nicht nur in den Ausführungen, sondern auch in der Form, welche in den Proportionen die klassische Geometrie der Vase aus Verona aufnimmt, typisch für die venezianische Herstellung von Glas.

Materialien

Aluminiumstruktur, Diffusor aus geblasenem Glas mit "Zanfirico"-Technik.

Spezifikation

Der Diffusor aus geblasenem Glas wird durch die "Zanfirico"-Technik hergestellt, eine Variante der Filigranarbeit mit verdrehten Fäden, die in der Renaissance entwickelt wurde.

Representa una reinterpretación de las técnicas de elaboración tradicional del vidrio no solo en los acabados sino también en la forma que recupera en las proporciones la geometría clásica del vaso Veronese, típica de la producción veneciana del vidrio.

Materiales

Estructura de aluminio, difusor de vidrio soplado con técnica "Zanfirico".

Especificaciones

El difusor de vidrio soplado está hecho con la técnica del Zanfirico, variante de la filigrana con hilos entrelazados desarrollada durante el Renacimiento.

Empatia 16, 26, 32 suspension

Carlotta de Bevilacqua
Paola di Arianello
2013

Materiali

Diffusore in vetro soffiato trasparente con finitura seta lucida; guida luce in metacrilato a basso coefficiente di assorbimento; corpo della lampada in alluminio pressofuso con finitura verniciata; rosone in tecnopolimero.

Materials

Diffuser in blown glass with a polished-silk finish; light pipe made of low absorption coefficient methacrylate; painted die-cast aluminium body lamp; ceiling rose in technopolymer.

Matériaux

Diffuseur en verre soufflé transparent avec finition soie brillante ; corps en aluminium moulé sous pression peint; guide lumière en méthacrylate à bas coefficient d'absorption ; rosace en techno-polymère.

Materialien

Schirm aus transparentem, mundgeblasenem Glas in seidig glänzendem Finish; Lichtstab aus Methacrylat mit niedrigem Absorptionskoeffizienten; Leuchtenkörper aus druckgegossenem, lackiertem Aluminium; Deckenbaldachin aus Technopolymer.

Materialies

Difusor en cristal soplado transparente con acabado seda lúcido; guía de luz en metacrilato de bajo coeficiente de absorción; cuerpo de la lámpara en aluminio fundido a presión y pintado; plancha de fijación a techo en polímero.



Light emission



Colours



White

Awards
2014 – Wallpaper Design Awards
2014 – iF Product Design Award



Empatia 16



Empatia 36

Materiali

Diffusore in vetro soffiato; corpo della lampada e rosone in tecnopolimero.

Materials

Blown glass diffuser; lamp body and ceiling rose in technopolymer.

Matériaux

Diffuseur en verre soufflé ; corps et rosace en techno-polymère.

Materialien

Schirm aus mundgeblasenem Glas; Leuchtenkörper und Deckenbaldachin aus Technopolymer.

Materialies

Difusor en cristal soplado, cuerpo de la lámpara y plancha de fijación a techo en tecnopolímero.

Awards

2015 - Reddot Design Award:
High Design Quality
Essen (Deutschland)

Light Off

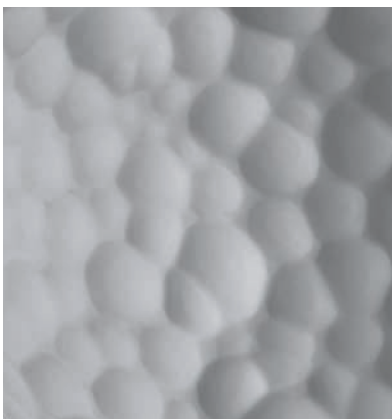

Light On

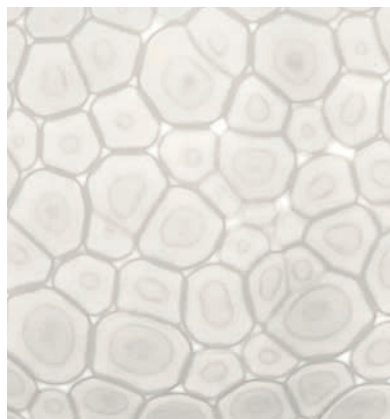

Light emission



Colours





LED

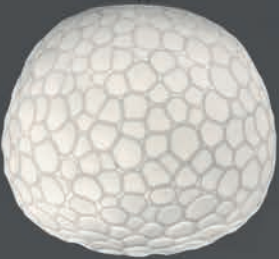

Meteorite 15

Meteorite 35

Meteorite 48

Castore 14, 25, 35, 42 suspension

Michele De Lucchi
Huub Ubbens
2003



Castore 42

Castore 25

Castore 14

Materiali

Rosone e stelo in policarbonato; diffusore in vetro soffiato.

Materials

Ceiling rose and stem in polycarbonate; blown glass diffuser.

Matériaux

Tige et rosace en polycarbonate ; diffuseur en verre soufflé.

Materialien

Deckenrosette und Stab aus Polycarbonat; Schirm aus mundgeblasenem Glas.

Materialies

Florón y cuerpo en policarbonato; difusor en cristal soplado.



Light emission



Colours



White

Awards

2004 – Design Plus, Light + Building
Frankfurt am Main (Deutschland)

2004 – Design Innovationen
Design Zentrum Nordrhein Westfalen
Reddot Design Award
Essen (Deutschland)

2004 – Compasso d'Oro / A.D.I. – Segnalazione
Milano (Italia)

Castore calice 18

Michele De Lucchi
Huub Ubbens
2004

Materiali

Rosone e stelo in policarbonato; diffusore in vetro soffiato.

Materials

Ceiling rose and stem in polycarbonate; blown glass diffuser.

Matériaux

Base en zamac, tige en polycarbonate ; diffuseur en verre soufflé.

Materialien

Deckenrosette und Stab aus Polycarbonat; Schirm aus mundgeblasenem Glas.

Materiales

Florón y varilla en policarbonato, difusor en cristal soplado.

Light emission



Colours



White



Materiali

Diffusore di vetro borosilicato con sabbiatura anti abbagliamento; struttura in alluminio verniciato, rosone in polycarbonato.

Specificità

Il diffusore è costituito da due coni sovrapposti, uno interno in metallo nero, uno esterno trasparente in vetro borosilicato soffiato. I due elementi producono un contrasto estetico, ma agiscono insieme per dar forma, dirigere e diffondere la luce.

Materials

Borosilicate glass diffuser, sand-blasted to prevent glaring; painted steel base, polycarbonate rose.

Specification

The diffuser consists of two overlapped cones, an inner black-metal one, and an outer clear blown borosilicate glass one. Both elements produce a contrasting look, while interacting to give shape, direct, and diffuse light.

Matériaux

Diffuseur en verre borosilicaté sablé anti-éblouissement ; structure en aluminium verni, rosace en polycarbonate.

Spécificité

Le diffuseur est formé de deux cônes superposés, l'un intérieur en métal noir, l'un extérieur transparent en verre borosilicaté soufflé. Les deux éléments produisent un contraste esthétique mais agissent ensemble pour donner forme à la lumière, la diriger et la diffuser.

Materialien

Diffusor aus Borosilikatglas mit Blendschutz-Sandstrahlung; Leuchtenstruktur aus lackiertem Aluminium, Rosette aus Polycarbonat.

Spezifikation

Der Diffusor besteht aus zwei überlagerten Kegeln, einer innen aus schwarzem Metall, einer außen transparent aus geblasenem Borosilikatglas. Die beiden Elemente erzeugen einen ästhetischen Kontrast, wirken aber zusammen, um das Licht zu formen, auszurichten und zu verteilen.

Materiales

Difusor de vidrio borosilicato con arenación antirreflejo; estructura de aluminio pintado, rosetón de polycarbonato.

Especificaciones

El difusor está compuesto por dos conos superpuestos, uno interno de metal negro, uno externo transparente de vidrio borosilicato soplado. Los dos elementos producen un contraste estético, pero actúan juntos para dar forma, dirigir y difundir la luz.

Light emission**Colours**

Black



Transparent



180

404



Stabligh

Arik Levy
2015

Il sistema di sospensione permette di distribuire la luce nello spazio in modo sempre diverso semplicemente ruotando i bracci della struttura e regolando le altezze dei corpi luminosi.

Materiali

Corpo lampada in alluminio, diffusore in vetro soffiato.

The suspension system allows to distribute light through space in an ever-changing way by simply rotating the arms of the frame and adjusting the height of the lighting bodies.

Materials

Aluminum body lamp, blown glass diffuser.

Le système de suspension permet de distribuer la lumière dans l'espace de manière toujours différente, simplement en faisant pivoter les bras de la structure et en réglant les hauteurs des corps lumineux.

Matériaux

Corps de la lampe en aluminium, diffuseur en verre soufflé.

Das Pendelsystem ermöglicht, das Licht im Raum stets auf verschiedene Weise zu verteilen, indem die Arme der Struktur einfach rotiert und die Höhen der Leuchtkörper reguliert werden.

Materialien

Aluminiumgehäuse Lampe, Schirm aus mundgeblasenem Glas.

El sistema de suspensión permite distribuir la luz en el espacio de una manera siempre diferente simplemente girando los brazos de la estructura y regulando las alturas de los cuerpos luminosos.

Materiales

Cuerpo de la lámpara de aluminio, difusor de vidrio soplado.

Awards

2016 - "Red Dot Award" High Design Quality

Light emission



Colours



Structure:
Black



Diffuser:
Brown



Diffuser:
Aquamarine



Diffuser:
Amber







Stabligh A, B, C

Arik Levy
2015

Tre diverse forme si combinano a tre colori per permettere la creazione di suggestive composizioni.

Materiali

Corpo lampada in alluminio, diffusore in vetro soffiato.

Three different shapes are combined with three colours to produce inspiring compositions.

Materials

Aluminum body lamp, blown glass diffuser.

Trois formes différentes unies à trois couleurs afin de permettre la création de compositions suggestives.

Matériaux

Corps de la lampe en aluminium, diffuseur en verre soufflé.

Drei verschiedene Formen vereinen sich zu drei Farben, um das Erstellen von eindrucksvollen Kompositionen zu ermöglichen.

Materialien

Aluminiumgehäuse Lampe, Schirm aus mundgeblasenem Glas.

Tres formas diferentes se combinan con tres colores para permitir la creación de composiciones fascinantes.

Materiales

Cuerpo de la lámpara de aluminio, difusor de vidrio soplado.

Awards

2016 - "Reddot Award" High Design Quality

Light emission



Colours



Structure:
Black



Diffuser:
Brown



Diffuser:
Aquamarine



Diffuser:
Amber



LED



Stablight A



Stablight B



Stablight C

Miconos

Ernesto Gismondi
1998

Materiali

Tige in metallo cromato lucido; diffusore in vetro soffiato trasparente.

Specificità

Tige adattabile alle diverse altezze dei soffitti.

Materials

Metal rode, diffuser in transparent blown glass.

Specification

Adjustable rod for different ceiling heights.

Matériaux

Tige en métal chromé brillant ; diffuseur en verre soufflé transparent.

Spécificité

Tige adaptable aux différentes hauteurs de plafond.

Materialien

Gestell aus verchromtem und poliertem Metall, Schirm aus klarem, mundgeblasenem Glas.

Spezifikation

Das Kabel ist für unterschiedliche Deckenhöhen justierbar.

Materiales

Varilla, de metal cromado brillante; difusor en cristal soplado transparente.

Especificaciones

Varilla se regula con arreglo a la altura del techo.



Awards

1998 – BIO 16 – Selection
Ljubljana (Slovenia)

Light emission



Colours



Rod:
Mirror



Diffuser:
Transparent



LED

492

492



Logico Logico mini

Michele De Lucchi
Gerhard Reichert
2001

Materiali

Struttura in alluminio verniciato; diffusore in vetro soffiato con finitura seta lucida. Soffiatura a tre strati (cristallo + effetto seta + cristallo) in stampo a fermo con forma capovolta per garantire solidità strutturale del vetro.

Specificità

Disponibile in due dimensioni e in tre configurazioni: singola, in linea e 3x120°. La forma modulare si presta alla componibilità e alla realizzazione di combinazioni personalizzate, fornite come progetto speciale.

Materials

Painted aluminium structure, blown glass diffuser with a polished-silk finish. Three layers of glass (crystal + silk + crystal) are blown in an upside down mould to ensure structural consistence to glass.

Specification

Available in two sizes and three configurations: single, in line and 3x120°. Its modular shape allows the creation of customized configurations, supplied as special products.

Matériaux

Structure en aluminium verni ; diffuseur en verre soufflé, finition soie brillante. Verre soufflé en trois couches (cristal + effet soyeux + cristal) dans un moule qui a une forme inversée pour garantir la solidité structurale du verre.

Spécificité

Disponible en deux tailles et en trois configurations : simple, en ligne et 3x120°. Sa forme modulaire, permet de nombreuses combinaisons capables de produire autant de compositions personnalisées, produit spécial à définir pour tout projet.

Materialien

Rahmen aus lackiertem Aluminium; Schirm aus geblasen- em Glas in seidig geblasenem Finish. Drei Glasschichten (Kristall + Seide + Kristall) die umgekehrt positioniert sind um die Stabilität des Glases zu gewährleisten.

Spezifikation

Erhältlich in zwei Größen und in drei Ausführungen: Einzel, in Linie und 3x120°. Eine individuelle Anordnung der Leuchtenmodule ist auf Wunsch als Sonderleuchte möglich.

Materiales

Estructura de aluminio pintado; difusor de cristal soplado con acabado de seda brillante. Soplado a tres capas (cristal + efecto seda + cristal) en un molde con forma invertida para asegurar la resistencia estructural del cristal.

Especificaciones

Disponible, en dos tamaños y en tres configuraciones: individual, en línea y 3x120°. Su forma modular, se presta para realizar combinaciones personalizadas, entrega como proyecto especial.

Light emission



Colours



Awards

Logico
2002 – Design Innovationen – Design Zentrum Nordrhein Westfalen
Reddot Design Award
Essen (Deutschland)

Logico micro
2004 – Design Plus, Light + Building
Frankfurt am Main (Deutschland)





Logico tobacco diffuser



Logico mini grey diffuser

Only for custom projects
– which feasibility must be approved
by Artemide technical design department –
it's possible to create different
combinations by joining
the elements Logico.

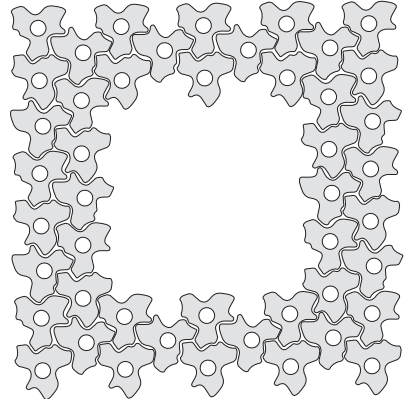
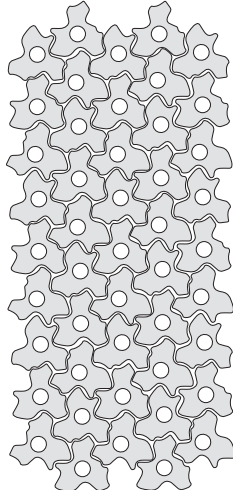
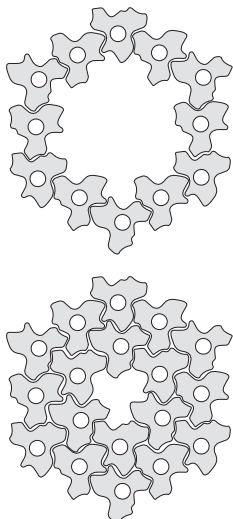



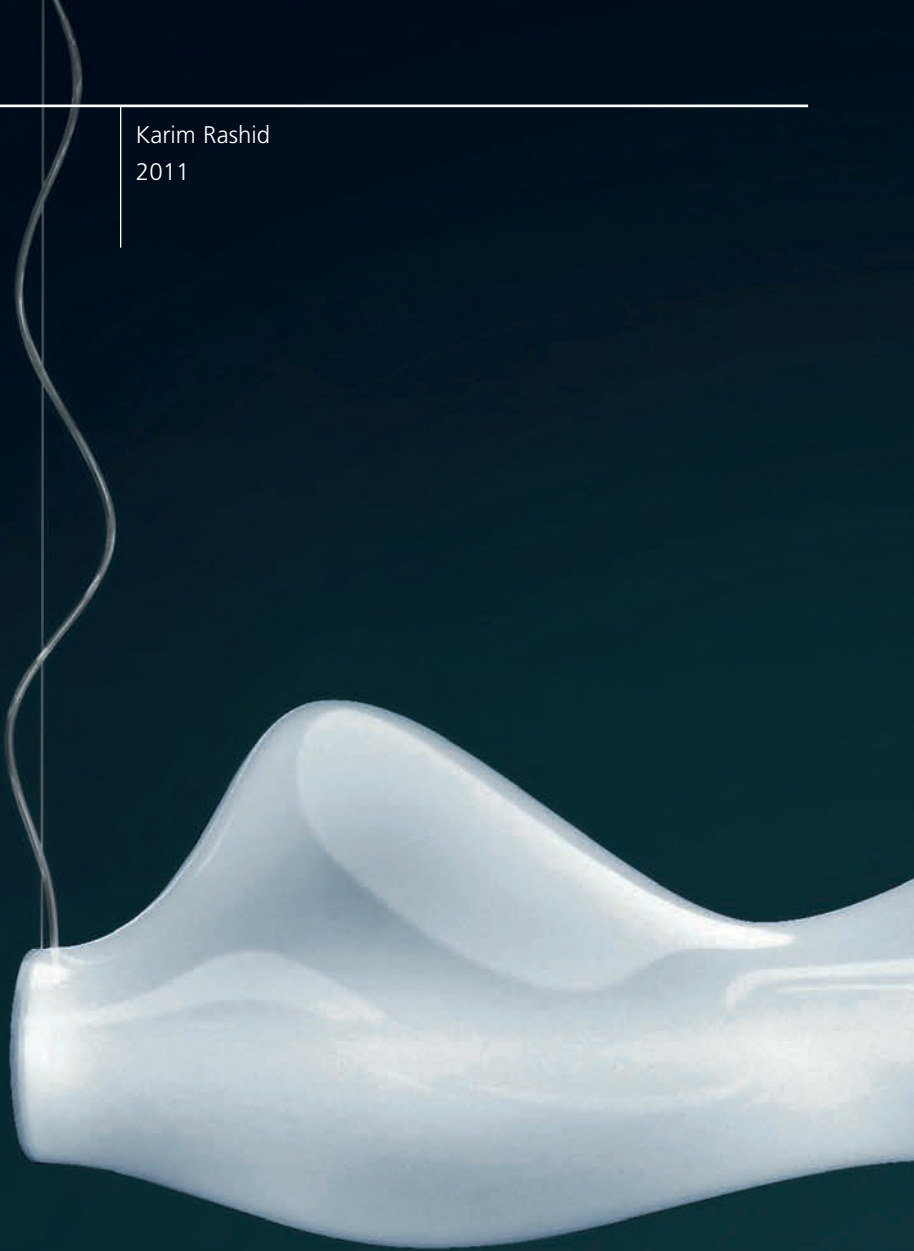

Light emission



Colours



White

**Materiali**

Tecnopolimero stampato in tecnica rotazionale con finitura superficiale lucida.

Specificità

L'elemento singolo può essere aggregato a formare un sistema composto da più moduli, per ottenere diverse configurazioni.

Materials

Rotationally moulded technopolymer, transparent finish.

Specification

Single elements could be joined to create a system with different possible configurations.

Matériaux

Techno-polymère roto-moulé, finition transparente.

Spécificité

Des éléments simples peuvent être assemblés de façon à créer un système de différentes configurations possibles.

Materialien

Technopolymer, hergestellt im Rotations-spritzgussverfahren, transparentes Finish.

Spezifikation

Die Einzelelemente lassen sich zu einem System zusammenfügen, so dass individuelle Konfigurationen geschaffen werden können.

Materiales

Polímero trabajado mediante moldeo rotacional con acabado transparente.

Especificaciones

El elemento individual puede ser añadido para formar un sistema compuesto por más módulos, para obtener diversas configuraciones.

Calenda

Italo Rota
Alessandro Pedretti
2011

Materiali

Tecnopolimero stampato in tecnica rotazionale.

Specificità

Sull'estremità superiore è posizionata una luce LED blu.

Materials

Rotationally moulded technopolymer.

Specification

A blue LED light is fitted on the upper end.

Matériaux

Techno-polymère roto-moulé.

Spécificité

Sur l'extrémité supérieure se trouve une lumière LED bleue.

Materialien

Technopolymer hergestellt im Rotations-spritzgussverfahren.

Spezifikation

Am oberen Ende ist ein blaues LED-Licht angebracht.

Materiales

Polímero trabajado mediante moldeo rotacional.

Especificaciones

En la extremidad superior está colocada una luz LED azul.

Light emission



Colours



White



Nuboli

Guido Matta
Enrico Girotti
2011

Materiali

Tecnopolimero stampato in tecnica rotazionale.

Materials

Rotationally moulded technopolymer.

Matériaux

Techno-polymère roto-moulé.

Materialien

Technopolymer hergestellt im Rotations-spritzgussverfahren.

Materialies

Polímero trabajado mediante moldeo rotacional.



Light emission



Colours



White

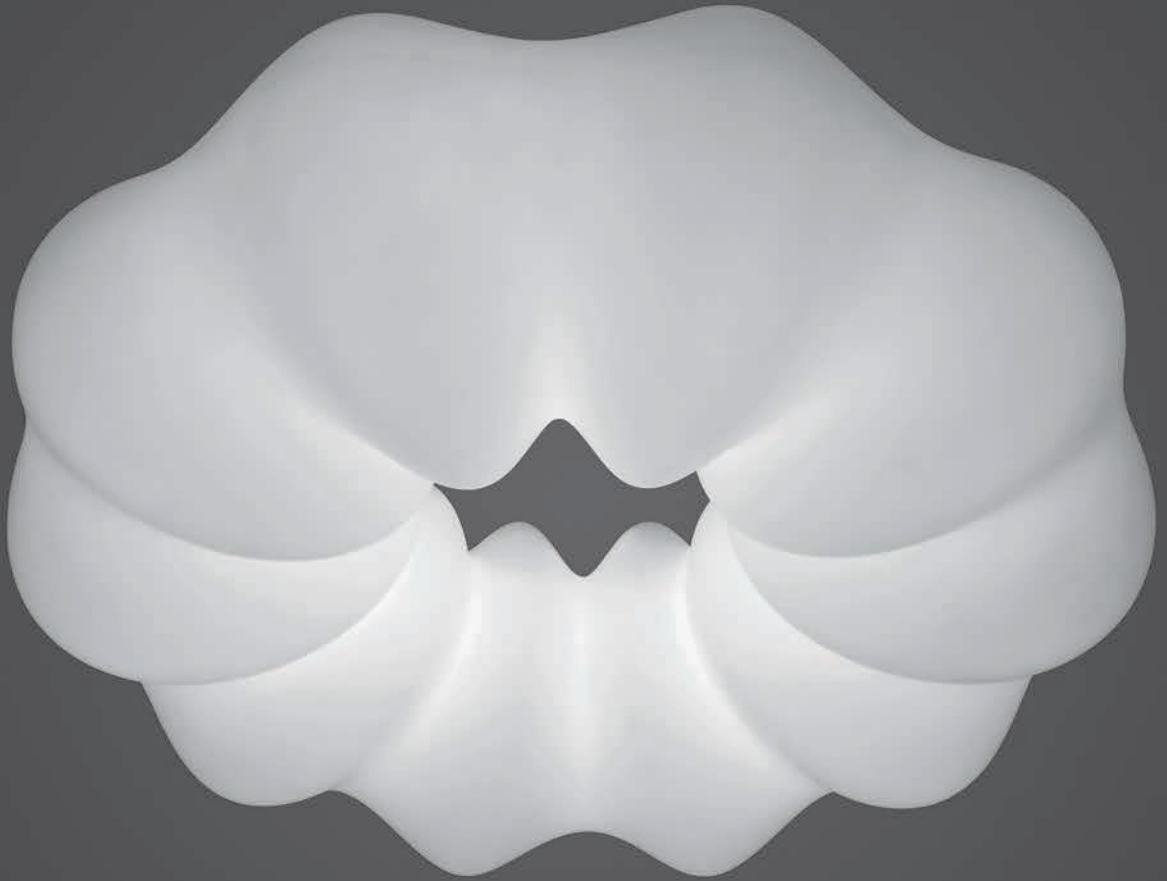

Mouette simmetrica
Mouette asimmetrica

Wilmotte & Industries
2004



Light emission



Colours



White

Awards

2005 – Design Innovationen
Design Zentrum Nordrhein Westfalen
Reddot Design Award 2005
"Reddot: best of the best"
Essen (Deutschland)



LED

Materiali

Struttura in estruso di alluminio verniciato; diffusore in polipropilene stampato in tecnica rotazionale; cavetti in acciaio.

Specificità

Disponibile nelle versioni simmetrica e asimmetrica, dimmerabile e non dimmerabile.

Materials

Extruded aluminium structure; rotational moulded polypropylene diffuser; steel suspension wires.

Specification

Available in the versions symmetrical and asymmetrical, dimmable and non dimmable.

Matériaux

Structure en aluminium extrudé ; diffuseur en polypropylène moulé ; câbles de suspension en acier.

Spécificité

Disponible en version symétrique et asymétrique, dimmable ou non dimmable.

Materialien

Montageprofil aus fließgepresstem Aluminium; Schirm aus Polypropylen hergestellt im Rotations-Spritzgussverfahren; Stahlseile.

Spezifikation

Erhältlich in den Versionen Asymmetrisch und Symmetrisch. Dimmbare Ausführung wahlweise erhältlich.

Materiales

Estructura en estruso de aluminio; difusor en polipropileno estampado con técnica rotacional; cables de suspensión en acero.

Especificaciones

Está disponible en versiones imétrica y asimétrica, dimerable y no dimerable.

Lana

Carlotta de Bevilacqua
2015

Materiali

Diffusore in policarbonato trasparente stampato a iniezione, struttura in metacrilato bianco.

Materials

Injection-moulded clear polycarbonate diffuser, white methacrylate frame.

Matériaux

Diffuseur en polycarbonate transparent moulé, structure en methacrylate blanc.

Materialien

Diffusor aus durchsichtigem Polycarbonat ist spritzgegossen, Leuchtenstruktur aus weißem Methacrylat.

Materiales

Difusor de policarbonato transparente estampado a inyección, estructura de metacrilato blanco.

Light emission



Colours



Structure:
White



Diffuser:
Transparent



Materiali

Struttura in policarbonato e acciaio; diffusore in tecnopolimero stampato in tecnica rotazionale.

Materials

Polycarbonate and steel frame; rotationally moulded technopolymer diffuser.

Matériaux

Structure en polycarbonate et acier; diffuseur en technopolymère roto-moulé.

Materialien

Die Leuchtenstruktur ist aus Polycarbonat und Stahl; Leuchtenkopfs aus Technopolymer hergestellt im Rotationsspritzgussverfahren.

Materiales

Estructura de policarbonato y acero; difusor de polímero trabajado mediante moldeo rotacional.

Light emission**Colours**

White

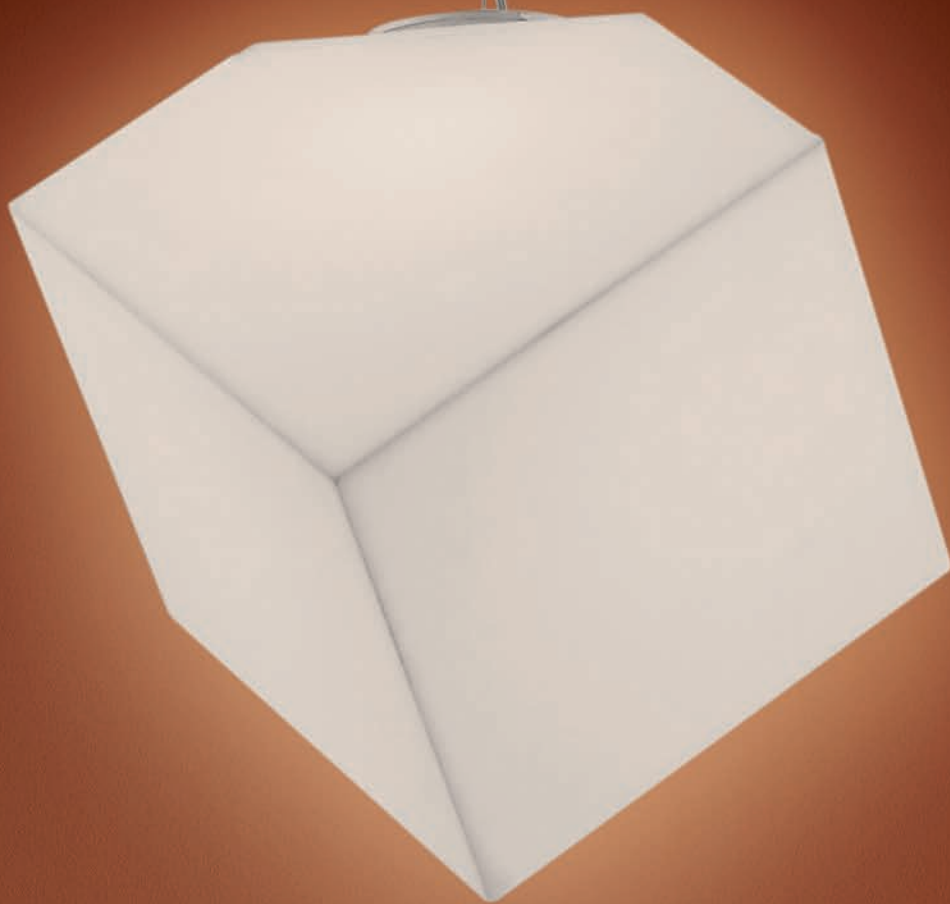

Choose suspension
Choose mega suspension

Matteo Thun
2008

Materiali

Diffusore in policarbonato accoppiato a un foglio di carta pergamena.

Materials

Diffuser in polycarbonate joined with parchment paper.

Matériaux

Diffuseur en polycarbonate couplé à une feuille de papier parchemin.

Materialien

Verstellbarer Schirm aus Polycarbonat mit Pergamentpapier.

Materialies

Difusor orientable de policarbonato junto con tela de pergamino.



Light emission



Colours



Transparent + Natural



Transparent + White



Choose Mega

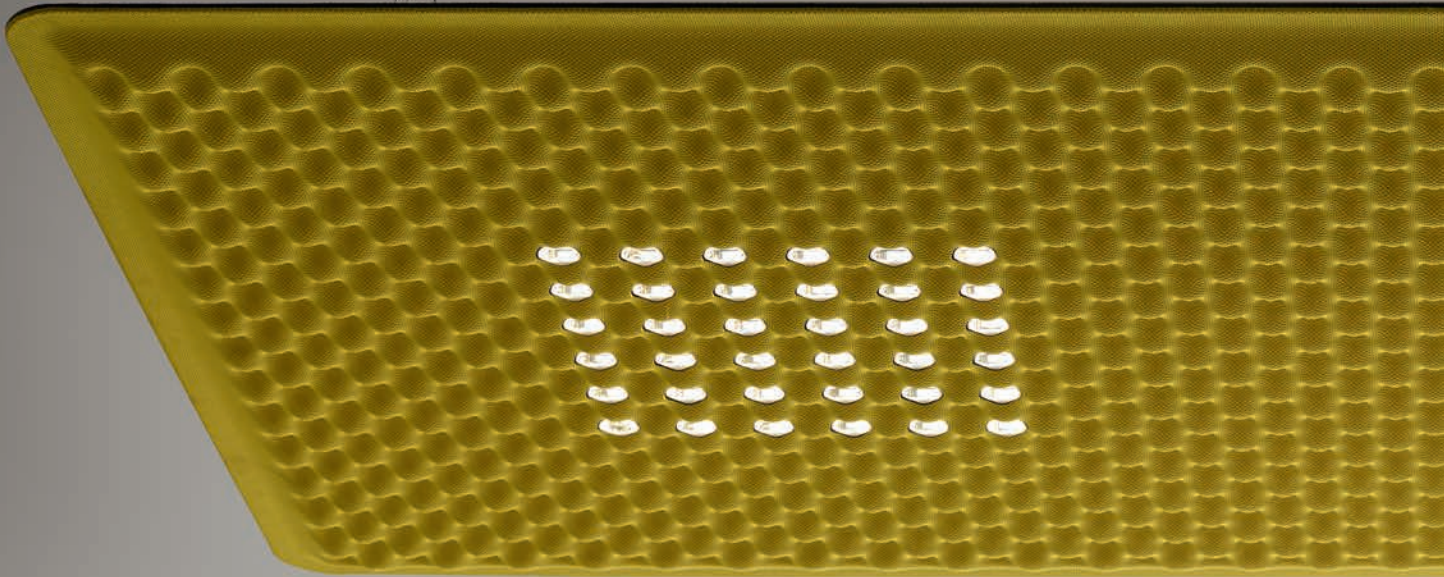

Awards

2016 - "Red Dot Award : Best of the Best"
2016 - Lux Awards Middle East
2016 - iF Product Design Award

Light emission

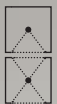

Colours

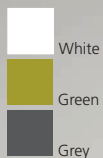

Apparecchio a sospensione con proprietà di assorbimento acustico grazie al particolare disegno a sezione sinusoidale della superficie inferiore e all'utilizzo di materiale fonoassorbente.

Materiali

PET.

Specificità

Efficacia acustica garantita in uno spazio definito dal posizionamento a un metro circa sopra la testa di chi parla e ascolta.
Emissione diretta: un board con elevato numero di LED a bassa potenza garantisce il massimo comfort luminoso. I riflettori possono essere ruotati per l'utilizzo su singola o doppia scrivania contrapposta. Conforme alle norme previste per le attività di ufficio con presenza di video terminali (UGR<19). Disponibile in 3 colori (verde, bianco, grigio) e in 2 dimensioni (1600X800mm - 800X800mm).

Suspension appliance with sound-absorbing properties ensured by an unusual sinusoidal cross-section design of the lower surface and the use of a sound-absorbing material.

Materials

PET.

Specification

Acoustic efficiency is ensured within a limited space by positioning at approximately one metre above the head of the speaker and listener. Direct emission: a board with a high number of low-voltage LEDs ensures maximum lighting comfort. Reflectors can be rotated for use on single or counterposed double desk.
Complies with the norms on office activities that involve the use of video-terminals (UGR<19). Available in 3 colours (white, grey, green) and 2 different sizes (1600X800mm - 800X800mm).



LED

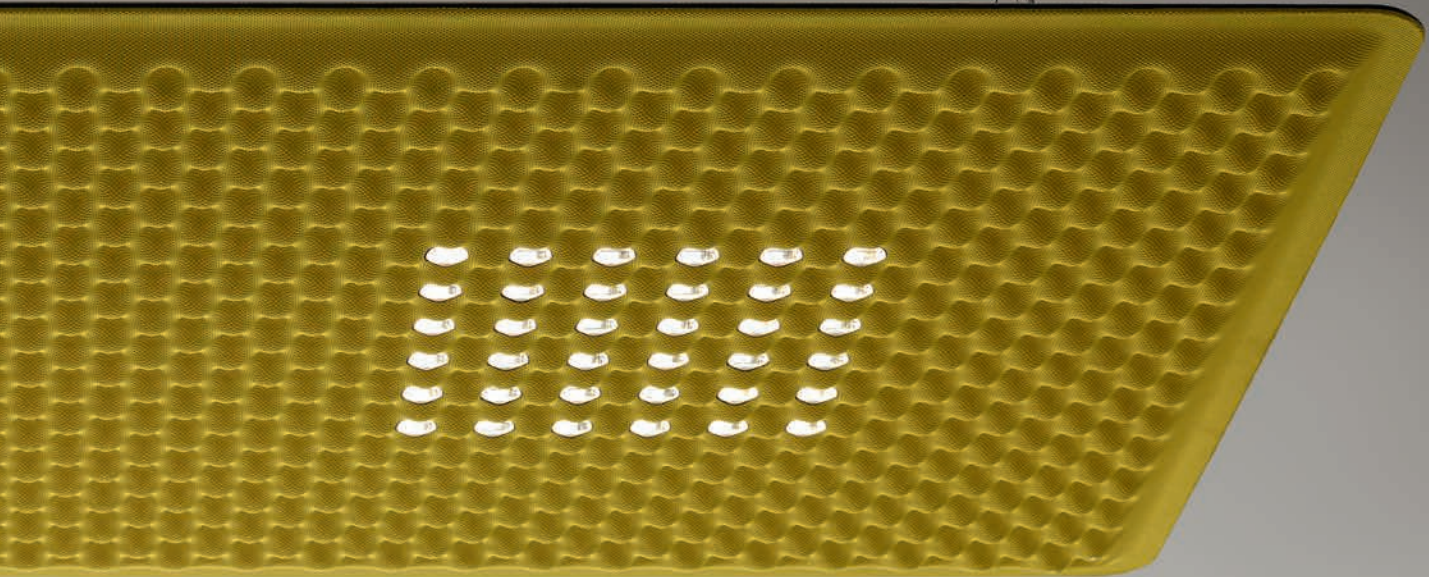

Suspension aux propriétés d'absorption acoustique, grâce au design particulier à coupe sinusoidale de la surface inférieure et à l'utilisation d'une matière phono-absorbante.

Matériaux
PET.

Spécificité
Efficacité acoustique garantie dans un espace défini par la mise en place à environ un mètre au-dessus de la tête de ceux qui parlent et écoutent. Émission directe : un tableau au grand nombre de LED à basse puissance garantit le maximum de confort lumineux. Les réflecteurs peuvent être tournés pour une utilisation sur un bureau simple ou double opposé. Conforme aux réglementations prévues pour les activités de bureau avec présence d'écrans vidéo (UGR<19). Disponible en 3 coloris (vert, blanc, gris) et 2 dimensions (1600X800mm et 800X800mm).

Pendelleuchte mit schallabsorbierenden Eigenschaften aufgrund des besonderen Designs der unteren Oberfläche in Sinusform und durch die Verwendung von schallabsorbierendem Material.

Materialien
PET.

Spezifikation
Gewährleistet akustische Effizienz in einem definierten Bereich bei einer Positionierung von ungefähr einem Meter über dem Kopf des Sprechers oder Zuhörers.
Direkte Lichtemission: ein Board mit einer hohen Anzahl an LEDs von niedriger Leistung gewährleistet maximalen Leuchtkomfort. Die Reflektoren können für den Einsatz bei Einzel- oder sich gegenüberliegenden Doppelschreibtischen rotiert werden.
Gemäß den vorgesehenen Normen für Bürotätigkeiten mit Video Arbeitsflächen (UGR<19). Erhältlich in 3 Farben (Grün, Weiß, Grau) und in 2 Dimensionen (1600X800mm und 800X800mm).

Dispositivo de suspensión con propiedades de absorción acústica gracias al particular diseño de sección sinusoidal de la superficie inferior y al uso de material fonoabsorbente.

Materiales
PET.

Especificaciones
Eficacia acústica garantizada en un espacio definido por la colocación a un metro aproximadamente por encima de la cabeza de quien habla y escucha. Emisión directa: un tablero con un elevado número de LEDs de baja potencia asegura el máximo confort luminoso. Los reflectores se pueden girar para su uso en un escritorio individual o doble opuesto. Cumple con las normas previstas para las actividades de oficina con presencia de terminales de vídeo (UGR<19). Disponible en 3 colores (verde, blanco, gris) y en 2 tamaños (1600X800mm - 800X800mm).



Eggboard matrix 800x800 direct



Eggboard matrix 800x800 direct + indirect

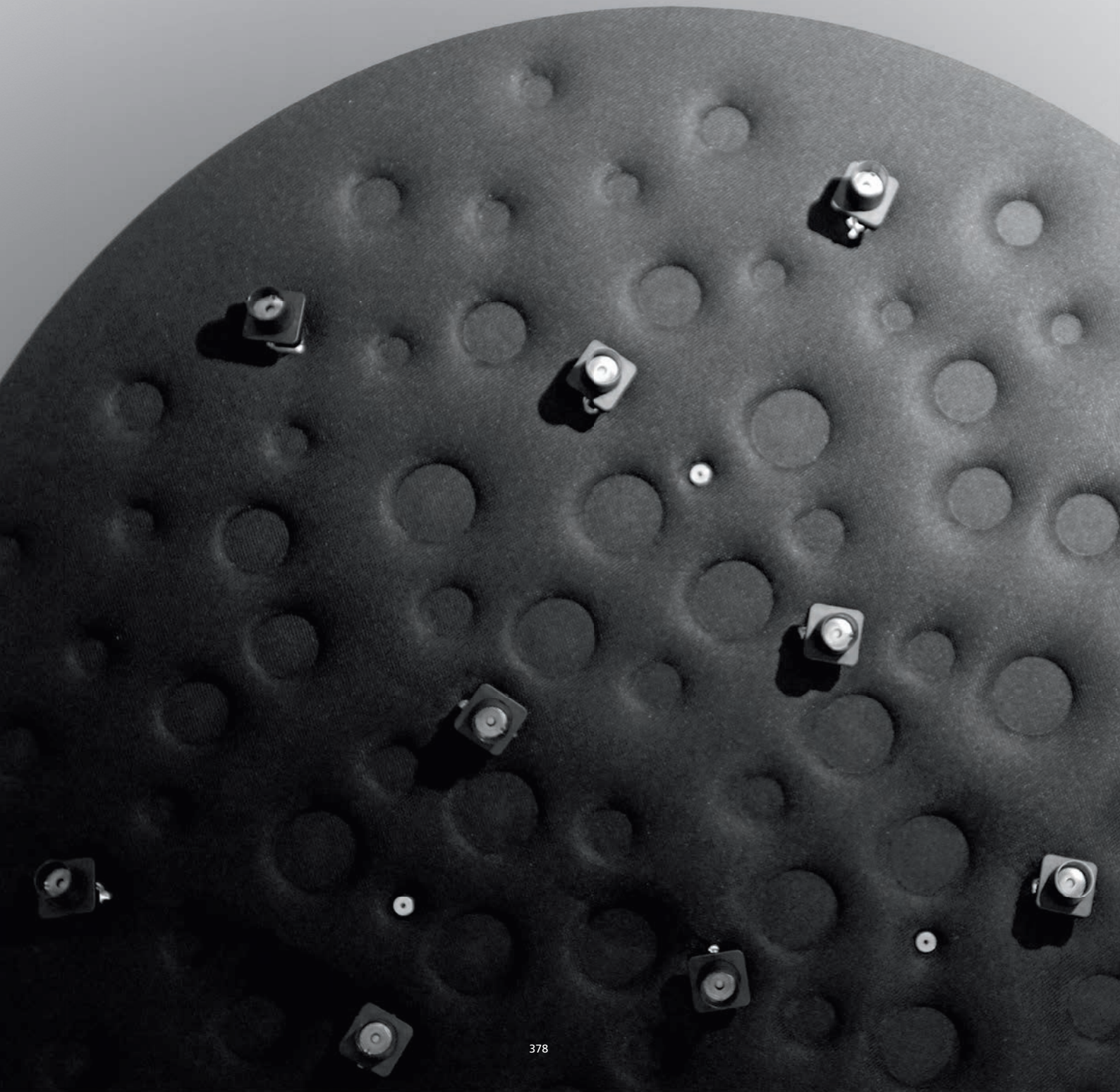



LED

Apparecchio a sospensione con proprietà di assorbimento acustico.

Materiali

PET, tecnopolimero.

Specificità

Le diverse densità del materiale che compone il pannello inferiore, contribuiscono all'assorbimento di differenti frequenze. Hanno proprietà acustiche sia la superficie superiore che quella inferiore dell'apparecchio. Ogni elemento è dotato di 12 spot LED orientabili di 30° grazie ad un sistema brevettato. Disponibile in cinque combinazioni colore.

Suspension appliance with sound-absorption properties.

Materials

PET, technopolymer.

Specification

The varying densities of the material used for the lower panel promote the absorption of different frequencies. Both the upper and the lower surface of the appliance feature sound-absorbing properties. Each unit is equipped with 12 30°-adjustable LED spots based on a patented system. Available in five colour combinations.

Appareil à suspension aux propriétés d'absorption acoustique.

Matériaux

PET, technopolymère.

Spécificité

Les différentes densités de la matière qui compose le panneau inférieur contribuent à l'absorption de différentes fréquences. Les surfaces supérieure et inférieure de l'appareil ont des propriétés acoustiques. Chaque élément est équipé de 12 spots LED orientables de 30° grâce à un système breveté. Disponible en cinq associations de couleurs.

Pendelleuchte mit der Eigenschaft der Schallabsorption.

Materialien

PET, Technopolymer.

Spezifikation

Die unterschiedlichen Dichten des Materials, aus denen das untere Paneel besteht, tragen zur Absorption der verschiedenen Frequenzen bei. Akustische Eigenschaften hat sowohl die obere als auch die untere Fläche des Gerätes. Jedes Element besteht aus 12 um 30° verstellbare LED-Spots im patentierten System. In fünf Farbkombinationen erhältlich.

Aparato de suspensión con propiedades de absorción acústica.

Materiales

PET, tecnopolímero.

Especificaciones

Las diferentes densidades del material que compone el panel inferior, contribuyen a la absorción de distintas frecuencias. Tanto la superficie superior como la inferior del aparato tienen propiedades acústicas. Cada elemento está equipado con 12 spot LED orientables en 30° gracias a un sistema patentado. Disponible en cinco combinaciones de color.



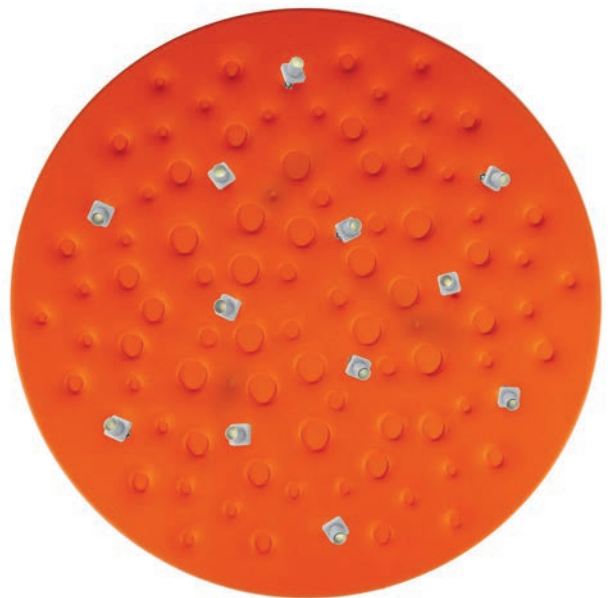
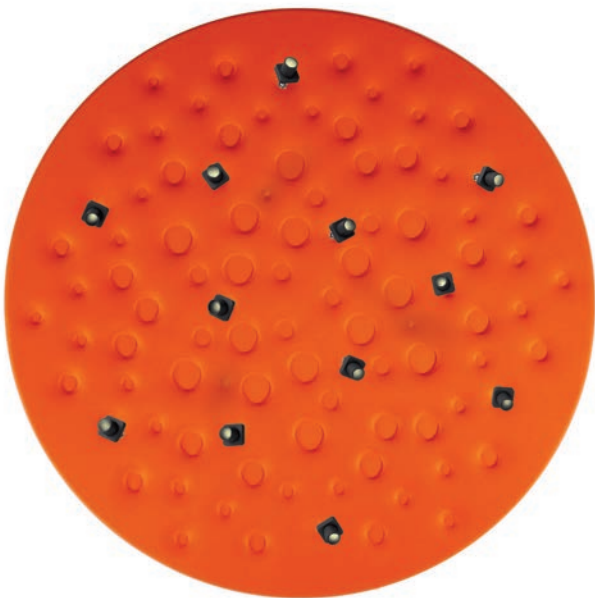

Light emission



Colours



White



Orange



Black

Apparecchio a sospensione con proprietà di assorbimento acustico.

Materiali

PET bicolore: l'interno bianco ottimizza la diffusione della luce. Calotta in vetro nella parte superiore.

Specificità

Grazie alle caratteristiche del materiale e alla geometria della cupola che intrappola le onde sonore viene diminuito il tempo di riverbero. L'effetto di assorbimento acustico è ottimale rispetto alle frequenze del parlato umano. Emissione diretta ed indiretta.

Suspension appliance with sound-absorbing properties.

Materials

Two-colour PET – the white inside optimizes light diffusion. Glass cap on the top.

Specification

The material's characteristics and the geometry of the dome that captures soundwaves reduce the reverberation time. The sound-absorption effect is optimized for the frequencies of human voice. Direct and indirect emission.

Appareil à suspension aux propriétés d'absorption acoustique.

Matériaux

PET bicolore ; l'intérieur blanc optimise la diffusion de la lumière. Calotte en verre dans la partie supérieure.

Spécificité

Grâce aux caractéristiques de la matière et à la géométrie de la coupole qui arrête les ondes sonores, on diminue le temps de réverbération. L'effet d'absorption acoustique est optimal par rapport aux fréquences de l'élocution humaine. Emission directe et indirecte.

Pendelleuchte mit der Eigenschaft der Schallabsorption.

Materialien

Zweifarbiges PET: Das Weiß innen optimiert die Lichtstreuung. Glashaube im oberen Bereich.

Spezifikation

Aufgrund der Eigenschaften des Materials und der Geometrie der Wölbung, welche die Schallwellen einfängt, wird die Nachhallzeit reduziert. Die Wirkung der Schallabsorption ist optimal hinsichtlich der menschlichen Sprachfrequenzen. Direkte und indirekte Emission.

Aparato de suspensión con propiedades de absorción acústica.

Materiales

PET bicolor: el interior blanco optimiza la difusión de la luz. Casquete de vidrio en la parte superior.

Especificaciones

Gracias a las características del material y la geometría del casquete que atrapa las ondas sonoras se reduce el tiempo de reverberación. El efecto de absorción acústica de las frecuencias del habla humana es óptimo. Emisión directa e indirecta.

Light emission



Colours



Inside
White



Outside:
Black



LED

528
530



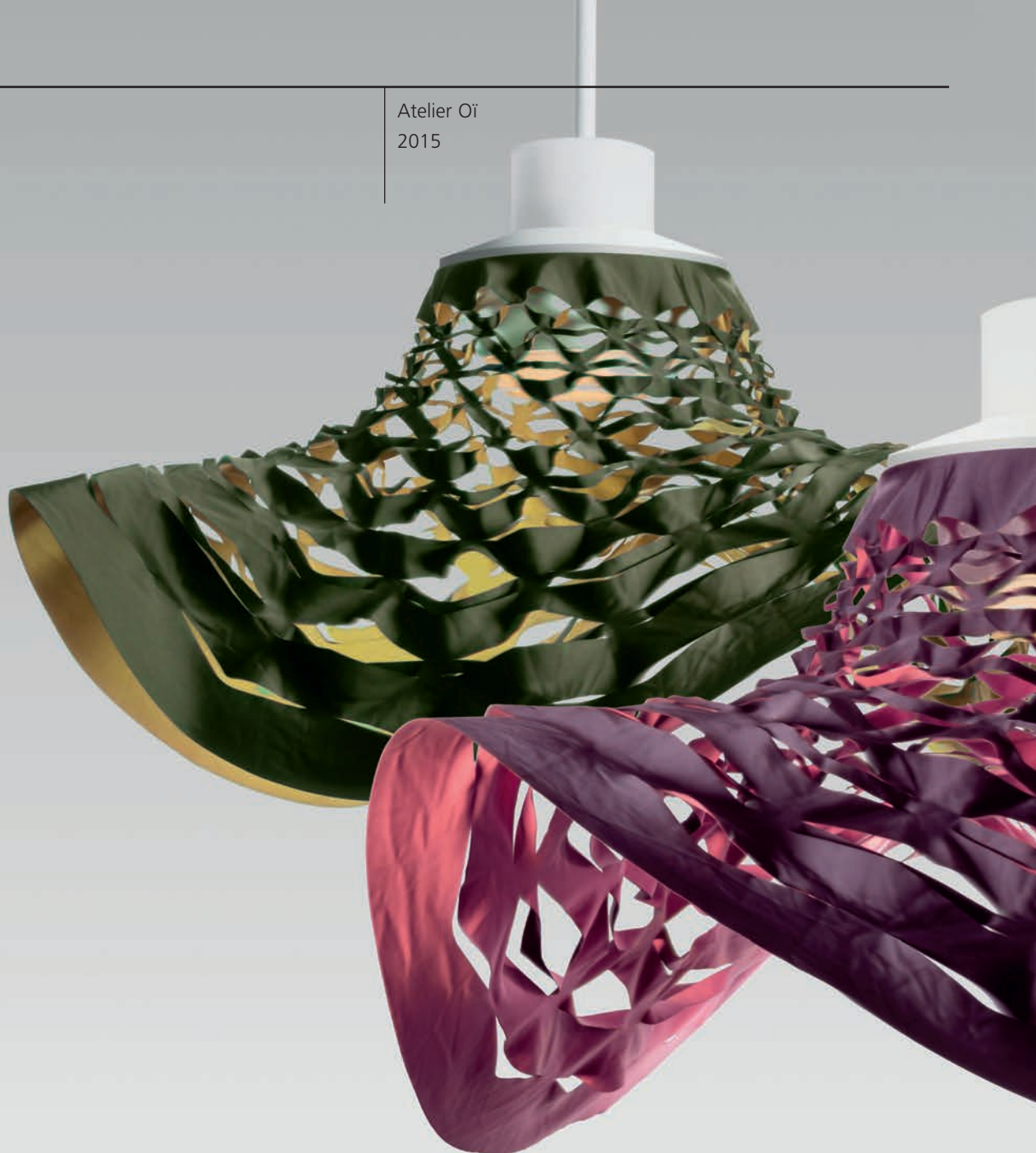

Unisce in un prodotto ibrido luce e aria per una migliore qualità ambientale.

Materiali

Tessuto, alluminio

Specificità

Il tessuto in rotazione gioca con grazia con la resistenza dell'aria definendo il movimento armonico delle sue forme che variano con la velocità. Il tessuto bicolore è reversibile. La luce e la velocità sono regolabili separatamente.

Combines light and air in a hybrid product to improve environmental quality.

Materials

Fabric, aluminium

Specification

The rotating fabric gracefully opposes air resistance and defines the harmonious movement of forms that change according to speed. The two-colour fabric is reversible. Light and speed can be adjusted separately.

Elle unit la lumière et l'air en un produit hybride pour une meilleure qualité environnementale.

Matériaux

Tissu, aluminium

Spécificité

le tissu pivotant joue gracieusement avec la résistance de l'air, définissant le mouvement harmonieux de ses formes qui varient avec la vitesse. Le tissu bicolore est réversible. La lumière et la vitesse sont réglables séparément.

Sie verschmilzt ein Hybrid-Produkt von Licht und Luft für eine verbesserte Raumqualität.

Materialien

Stoff, Aluminium

Spezifikation

Das rotierende Gewebe spielt anmutig mit dem Luftwiderstand und definiert die harmonische Bewegung seiner Formen, die mit der Geschwindigkeit variieren. Das zweifarbige Gewebe ist reversibel. Das Licht und die Geschwindigkeit sind separat einstellbar.



LED

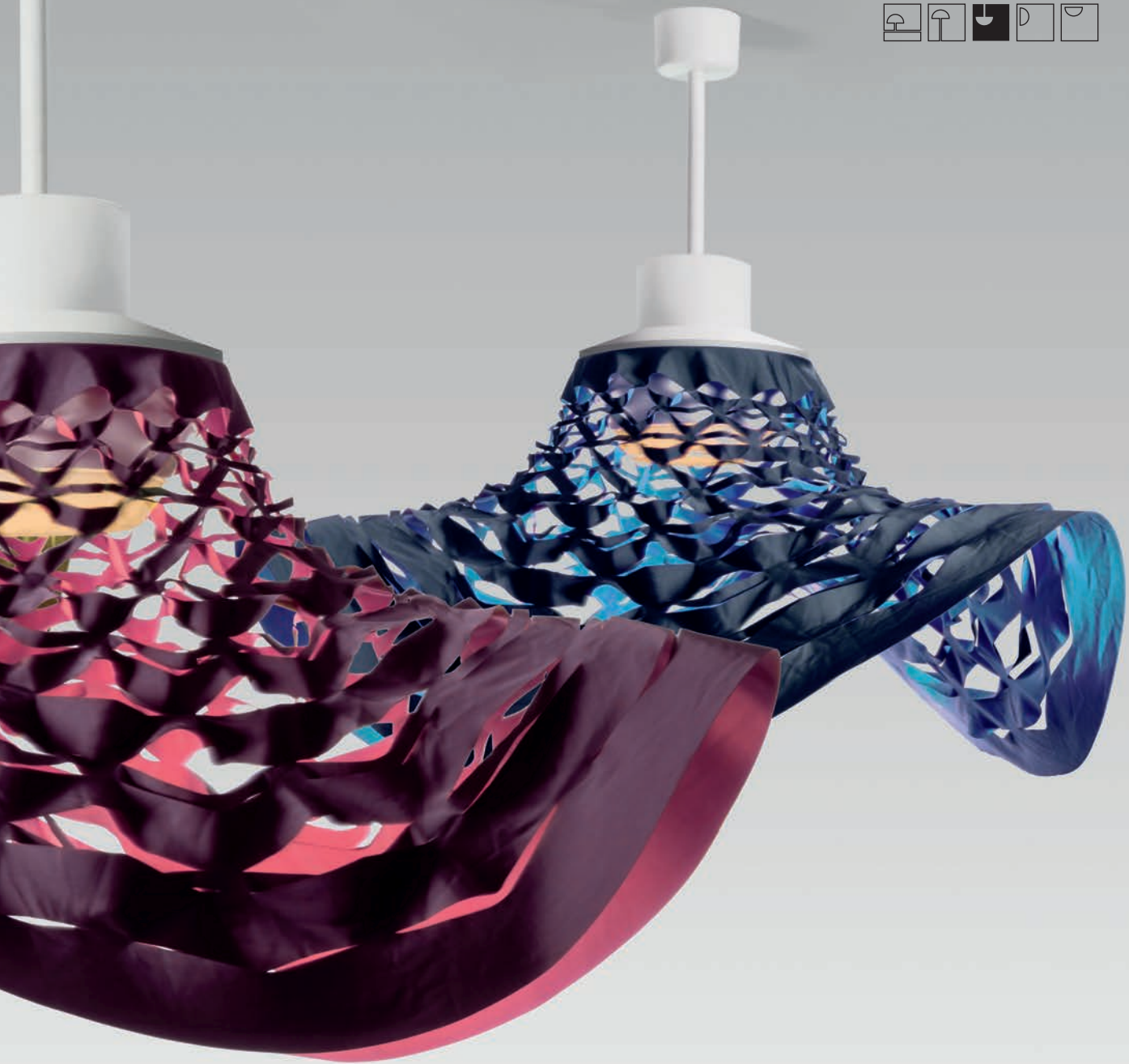

Combina en un producto híbrido luz y aire para un mejor calidad ambiental.

Materiales

Tejido, aluminio

Especificaciones

El tejido en rotación juega con gracia con la resistencia del aire definiendo el movimiento armónico de sus formas que varían según la velocidad. El tejido bicolor es reversible. La luz y la velocidad se pueden regular por separado.

Awards

2017 – Reddot Design Award
Essen (Deutschland)

2016 - Design Plus Light+Building Award
Frankfurt (Deutschland)



Light emission



Colours



Light blue/Blue



Ocher/Green



Violet/Purple



Lampade da parete

Wall lamps
Appliques
Wandleuchten
Apliques



392
Alphabet of light



400
Discovery wall



404
Vigo wall



406
Flashit



428
Tigia



430
Melete



432
Dinarco



434
Cabildo LED wall



454
Talak professional
wall



456
Tolomeo
mini, micro wall
braccio



458
Tolomeo faretto
micro faretto



460
Tolomeo pinza
micro pinza



480
Orbiter



482
Empatia
wall/ceiling



486
Meteorite
wall/ceiling



490
Dioscuri
wall/ceiling



408
Mesmeri



414
Talo



416
Talo 60
90, 120, 150



418
Islet



420
Pirce wall
Pirce micro wall



422
Microsurf



424
Rea



426
Cuma



436
Cadmo LED wall



438
Melampo wall

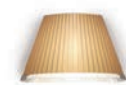

440
Choose wall



442
La Petite wall



444
Logico, Logico mini,
Logico micro wall



446
Teti



448
Demetra faretto



450
Demetra
micro, professional
wall



462
Tolomeo basculante
wall



464
Tolomeo mega
wall



466
Tolomeo diffusore
wall



468
Febe



472
Nebula



474
Droplet mini



476
Fiamma
wall/ceiling



478
Eclittica 20
wall/ceiling



492
Miconos wall



494
Crazy



496
Altrove LED



498
Altrove 600 LED



500
Edge
wall/ceiling



502
Miyako
wall

Lampade da soffitto

Ceiling lamps
Plafonniers
Deckenleuchten
Pláfonos



446
Teti



468
Febbe



472
Nebula



474
Droplet mini



496
Altrove LED



498
Altrove 600 LED



500
Edge
wall/ceiling



502
Miyako ceiling



520
Led Net Circle



522
Invero ceiling
Invero 214 ceiling



524
Incalmo ceiling
Incalmo 214 ceiling



526
Logico ceiling
Logico mini ceiling
Logico micro ceiling



476
Fiamma
wall/ceiling



478
Eclittica 20
wall/ceiling



480
Orbiter



482
Empatia
wall/ceiling



486
Meteorite
wall/ceiling



490
Dioscuri
wall/ceiling



492
Miconos ceiling



494
Crazy



504
Decomposé light
ceiling



506
Fiamma 15, 30
ceiling



508
Iosif



510
Trix

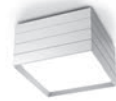

512
Groupage



514
Float circolare
ceiling

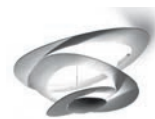

516
Pirce ceiling
Pirce mini ceiling



518
Led Net Line



526
Logico 3x120°
3x120° mini
3x120° micro
ceiling



528
Nur mini ceiling



530
Nur gloss mini
ceiling



532
Skydro



534
Droplet



536
Cosmic Angel
ceiling



538
Mercury
Mercury mini
ceiling



540
Botanic rain



Awards

2017 – Reddot Design Award
"Best of the Best", Essen (Deutschland)
2016 – Interior Design Magazine Award
Best of year



A partire da un abaco di essenziali elementi geometrici BIG disegna un nuovo font che si traduce in luce. Moduli base, lineari o curvi, dalle precise proporzioni geometriche permettono di combinare gli elementi costruendo infinite strutture di luce, essenziali o più complesse. È un principio elementare che genera un sistema aperto. Questa idea si combina alla competenza optoelettronica di Artemide per definire un principio costruttivo innovativo e restituire una luce continua e confortevole.

Materiali

Metacrilato diffondente stampato ad iniezione.

BIG starts from an abacus of essential geometries to design a new font that translates into light. Base modules, either linear or curved, with precise geometric proportions, allow to combine the individual elements to create countless lighting structures, both essential and complex. It is a basic principle that generates an open system. This idea is associated with the optoelectronic skills of Artemide to define an innovative construction principle and produce continuous and comfortable light.

Materials

Injection moulded diffused methacrylate.

A partir d'un abaque d'éléments géométriques essentiels, BIG trace un nouveau caractère qui se traduit par la lumière. Des modules de base, linéaires ou courbes, aux proportions géométriques précises, permettent d'associer les éléments en construisant des structures de lumière infinies, essentielles ou plus complexes. C'est un principe élémentaire qui engendre un système ouvert. Cette idée s'associe à la compétence optoélectronique d'Artemide pour définir un principe constructif innovant et restituer une lumière continue et confortable.

Matériaux

Méthacrylate diffusant moulé.

Ausgehend bei einem Abakus geometrischer Grundelemente zeichnet BIG ein neues Font, das sich in Licht übersetzt. Dieses Konzept verbindet sich mit der optoelektronischen Kompetenz von Artemide, ein innovatives Konstruktionsprinzip zu definieren und ein kontinuierliches und behagliches Licht wiederzugeben. Die Kombination der Geometrie zum Abschnitt und die Leuchteigenschaften der Materialien erzeugen eine diffuse und gleichmäßige Lichtemission ohne Schatten und Blendung von zugleich hoher Leistung.

Materialien

Spritz Gegossen Diffundieren Methacrylat.

A partir de un ábaco de elementos geométricos esenciales, BIG diseña una fuente nueva que se traduce en luz. Esta idea se combina con la competencia optoelectrónica de Artemide para definir un principio de construcción innovador y aportar una luz continua y confortable. La combinación de la geometría de la sección con las propiedades ópticas de los materiales crea una emisión difusa y uniforme sin sombras y deslumbramiento garantizando, al mismo tiempo, un alto rendimiento.

Materiales

Metacrilato difusor estampado a inyeccion.

Light emission



Colour



White



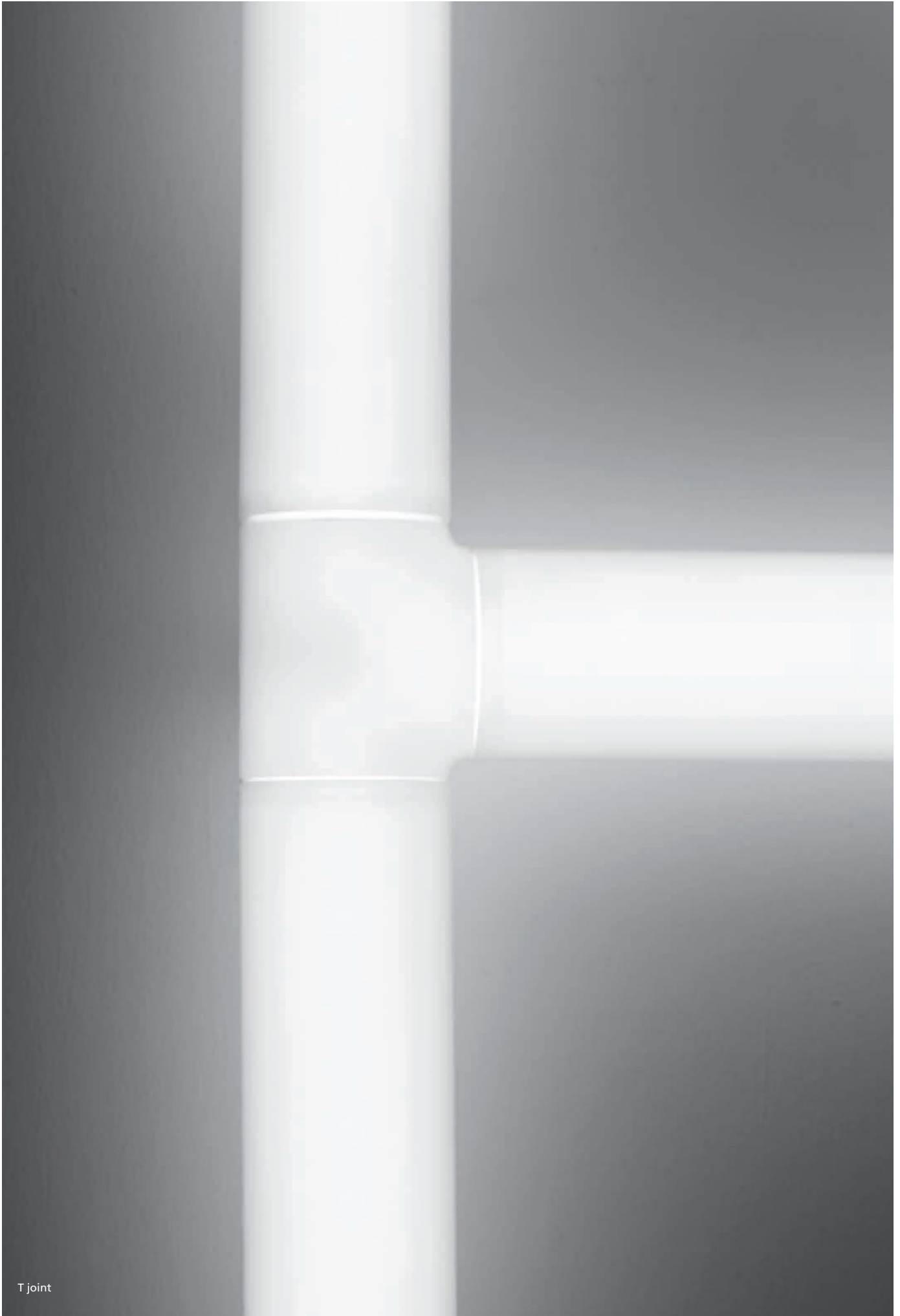

T joint



Linear joint



L joint



Materiali

Struttura in alluminio, diffusore in tecnopolimero.

Specificità

Un profilo leggerissimo circolare in alluminio è sede di una strip LED che inietta la luce in una superficie plastica trasparente di nuova concezione. L'interno appare da trasparente a pieno di luce, l'assenza si trasforma in una superficie emittente perfettamente diffondente.

Materials

Aluminium frame, technopolymer diffuser.

Specification

An ultra-light aluminium profile hosts to a LED strip that injects light into a clear plastic surface based on a new concept. The look of the inside ranges from clear to full of light, absence is transformed into an emitting surface that ensures perfect diffusion.

Matériaux

Structure en aluminium, diffuseur en techno-polymère.

Spécificités

Un profil circulaire très léger en aluminium est le siège d'un strip LED qui injecte la lumière dans une surface plastique transparente nouvellement conçue. L'intérieur apparaît de transparent à plein de lumière, l'absence se transforme en une surface émettrice parfaitement diffusante.

Materialien

Aluminiumstruktur, Diffusor aus Technopolymer.

Spezifikation

Ein sehr leichtes, kreisförmiges Aluminiumprofil ist der Sitz einer LED-Lichtleiste, die das Licht auf eine durchsichtige Kunststofffläche wirft. Das Leuchteninnere erscheint von transparent zum vollen Licht, die Abwesenheit wird zu einer perfekt diffundierenden Emissionsfläche.

Materiales

Estructura de aluminio, difusor de polímero.

Especificaciones

Un perfil circular de aluminio muy ligero es sede de una tira LED que inyecta la luz en una superficie plástica transparente de nueva concepción. El interior aparece de transparente a lleno de luz, la ausencia se convierte en una superficie emisora perfectamente difusora.

Light emission



Colours



Diffuser:
Transparent



Structure:
Silver grey



LED

234





Light off



Light on



Materiali

Diffusore di vetro borosilicato con sabbiatura anti abbagliamento; struttura in alluminio verniciato, rosone in policarbonato.

Specificità

Il diffusore è costituito da due coni sovrapposti, uno interno in metallo nero, uno esterno trasparente in vetro borosilicato soffiato. I due elementi producono un contrasto estetico, ma agiscono insieme per dar forma, dirigere e diffondere la luce.

Materials

Borosilicate glass diffuser, sand-blasted to prevent glaring; painted steel base, polycarbonate rose.

Specification

The diffuser consists of two overlapped cones, an inner black-metal one, and an outer clear blown borosilicate glass one. Both elements produce a contrasting look, while interacting to give shape, direct, and diffuse light.

Matériaux

Diffuseur en verre borosilicaté sablé anti-éblouissement ; structure en aluminium verni, rosace en polycarbonate.

Spécificité

Le diffuseur est formé de deux cônes superposés, l'un intérieur en métal noir, l'un extérieur transparent en verre borosilicaté soufflé. Les deux éléments produisent un contraste esthétique mais agissent ensemble pour donner forme à la lumière, la diriger et la diffuser.

Materialien

Diffusor aus Borosilikatglas mit Blendschutz-Sandstrahlung; Leuchtenstruktur aus lackiertem Aluminium, Rosette aus Polycarbonat.

Spezifikation

Der Diffusor besteht aus zwei überlagerten Kegeln, einer innen aus schwarzem Metall, einer außen transparent aus geblasenem Borosilikatglas. Die beiden Elemente erzeugen einen ästhetischen Kontrast, wirken aber zusammen, um das Licht zu formen, auszurichten und zu verteilen.



180 346



Materiales

Difusor de vidrio borosilicato con arenación antirreflejo; estructura de aluminio pintado, rosetón de policarbonato.

Especificaciones

El difusor está compuesto por dos conos superpuestos, uno interno de metal negro, uno externo transparente de vidrio borosilicato soplado. Los dos elementos producen un contraste estético, pero actúan juntos para dar forma, dirigir y difundir la luz.

Light emission



Colours

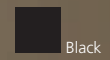





LED

Una linea di luce orientabile, adatta ad ogni situazione del living moderno.

Materiali

Struttura in alluminio; schermo in metacrilato con finitura satinata.

Specificità

Si fissa alle pareti o al soffitto senza vincoli tradizionali di posizionamento: la lampada può essere installata in modo verticale, orizzontale, obliqua. Alle due estremità, un sistema cinematico composto da calamite, permette la regolazione della direzione del flusso luminoso a seconda delle diverse esigenze.

An adjustable, flexible line of light allowing multiple lighting solutions for every living environment.

Materials

Aluminium frame; methacrylate screen with satin finish.

Specification

The profile is fixed to the wall or to the ceiling without any restrictions, as the lamp can be installed vertically, horizontally, or obliquely. At both ends, a kinematic system based on magnets allows to adjust the direction of the luminous flow according to individual needs.

C'est une ligne de lumière orientable adaptée à toute situation d'un espace à vivre.

Matériaux

Structure en aluminium, écran en méthacrylate avec une finition satinée.

Spécificités

Le produit peut être fixé au mur et au plafond sans aucune contrainte de positionnement. La lampe peut être installée de manière verticale, horizontale ou oblique. Aux deux extrémités, un système cinématique composé d'aimants permet le réglage de la direction du flux lumineux selon les différentes exigences.

Eine ausrichtbare Lichtlinie für moderne Wohnambiente.

Materialien

Struktur aus Aluminium; Schirm aus Methacrylat mit opalinem Finish.

Spezifikation

Lässt sich problemlos ohne herkömmliche Positionierungs einschränkungen vertikal, horizontal oder schräg an Wänden oder Decken anbringen. Über ein kinematisches System auf der Basis von Magneten an beiden Enden des Objekts kann die Ausrichtung des Lichts entsprechend der jeweiligen Anforderungen vorgenommen werden.

Una línea de luz orientable, adaptable a cada situación de la vida moderna.

Materiales

Estructura en aluminio, pantalla en metacrilato con acabado satinado.

Especificaciones

El perfil se fija a la pared o al techo sin ninguna de las restricciones de posición tradicional: la lámpara se puede instalar de manera vertical, horizontal, oblicua. En ambos extremos, un sistema cinemático basado en imanes permite ajustar la dirección del flujo luminoso de acuerdo a las necesidades individuales.

Light emission



Colours



White

Materiali

Alluminio pressofuso verniciato, cromato o ramato.

Materials

Painted, chromed or copper-plated die-cast aluminium.

Matériaux

Aluminium moulé verni, chromé, ou cuivré.

Materialien

Leuchtenkörper aus lackiertem Aluminiumdruckguss oder aus mattem, glänzendem Chrom oder Verkupfert.

Materialies

Aluminio presofuso pintado, cromado o cobrizo.



Awards

2006 – iF Produkt Design Award
Hannover (Deutschland)

2006 – Reddot Design Award – Product Design
Essen (Deutschland)

2007 – Good Design Award
The Chicago Atheneum, Chicago (US)

Light emission



Colour



White



Mirror



Silver grey



Copper satin



LED

LED



Silver grey

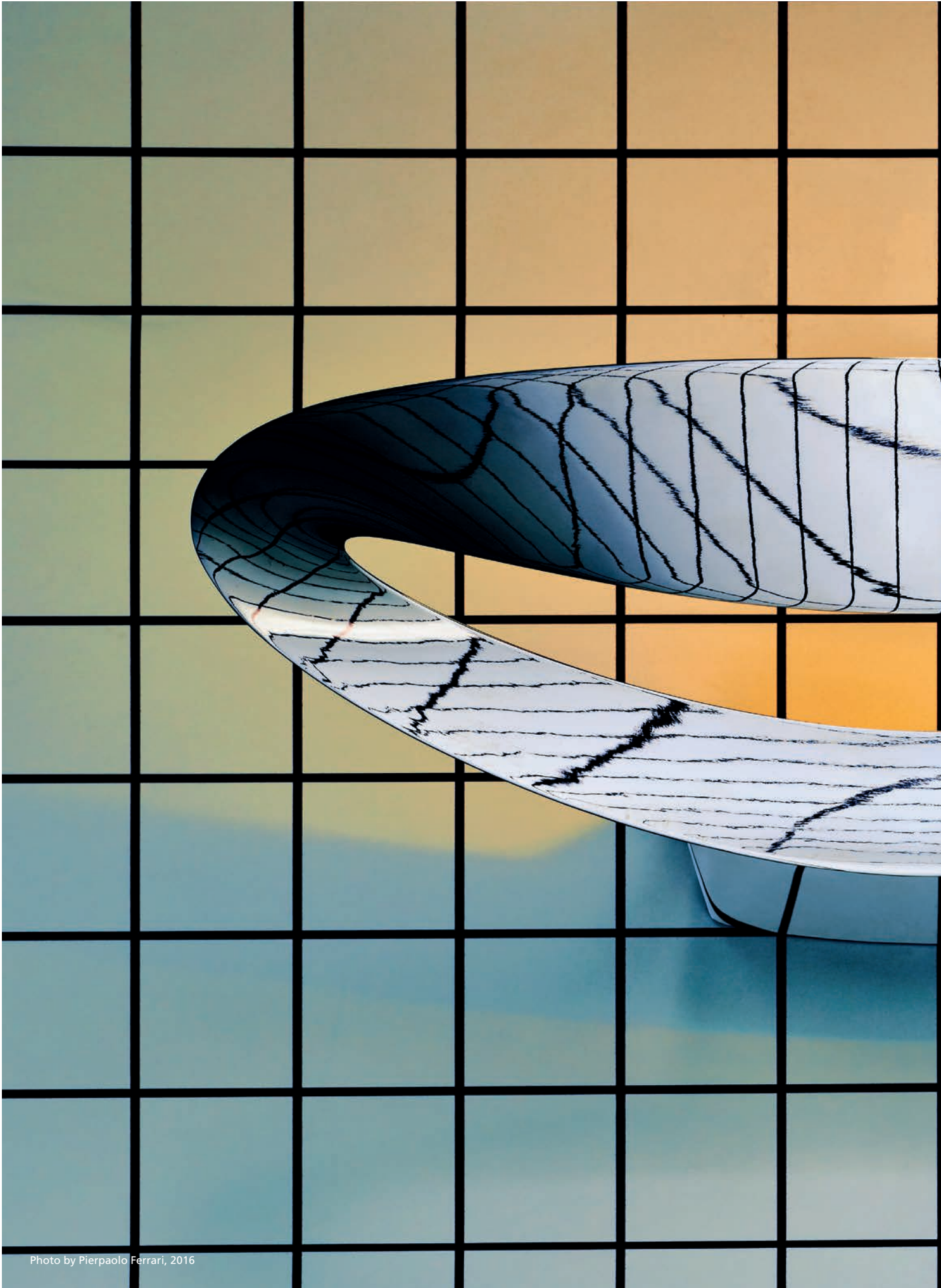
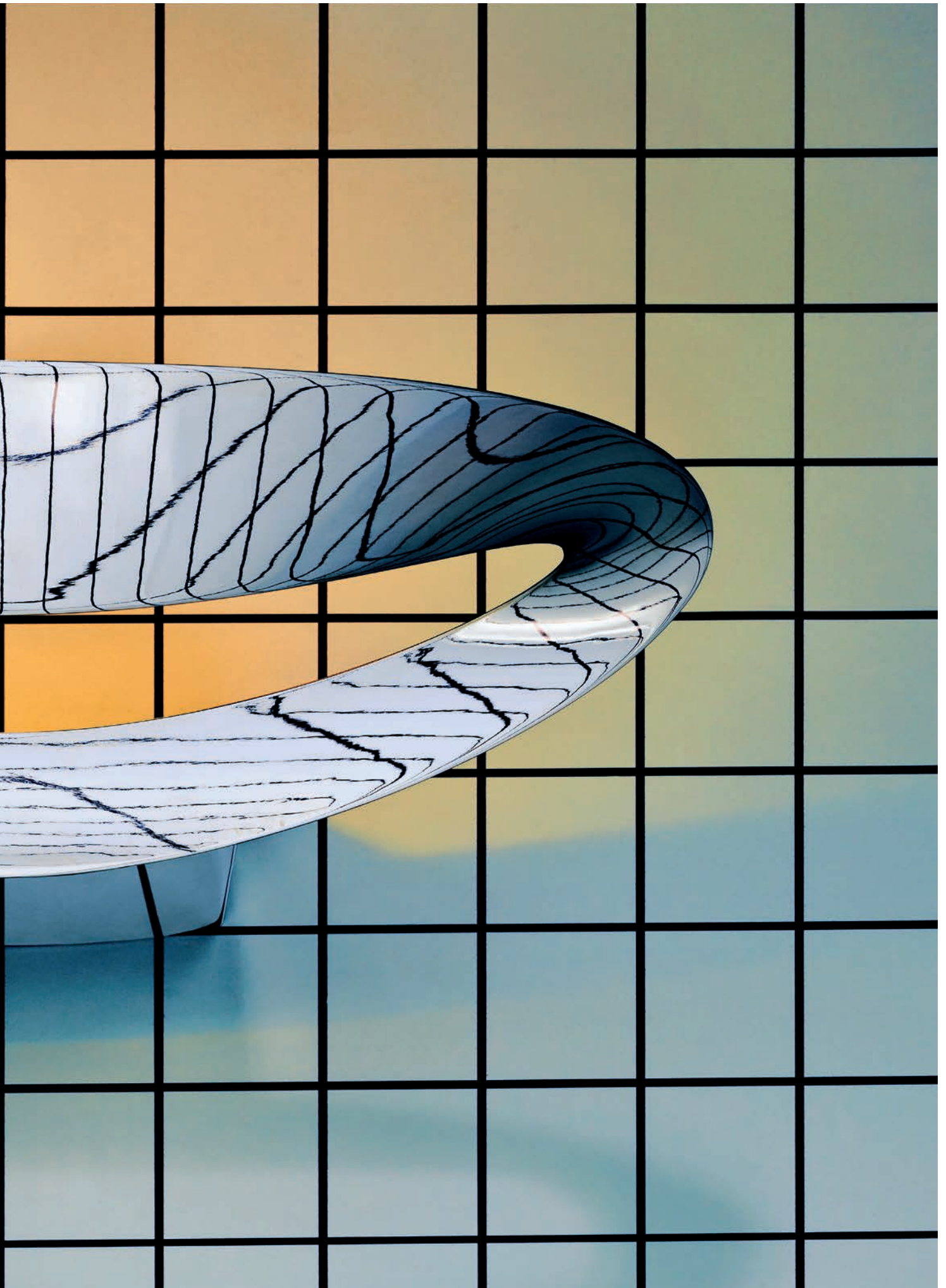

Photo by Pierpaolo Ferrari, 2016





Copper satin

Mesmeri LED

La nuova tecnologia di alimentazione LED e l'utilizzo di specifici LED progettati per essere utilizzati in circuiti non SELV consente per la prima volta di sostituire in modo trasparente per l'utente sia in termini prestazionali che di design la matura tecnologia ad alogeni con la ben più performante tecnologia LED. Il modulo LED utilizzato consente di disporre infatti di un significativo pacchetto lumen, con un'appropriata temperatura di colore (3000K/2700K) ed una buona resa cromatica (CRI 90). Inoltre per il funzionamento non necessita dell'utilizzo di ingombranti dispositivi di alimentazione esteticamente invasivi. Il sofisticato sistema di alimentazione adottato riduce drasticamente effetti di flicker presenti in soluzioni analoghe basate sul raddrizzamento di alimentazioni in corrente alternata e garantisce buone efficienze ed una aspettativa di vita comparabile a quella dei LED in uso.

Mesmeri LED

Thanks to the new LED power supply technology and to the use of LEDs specifically designed to be used in non-SELV circuits, for the first time the traditional halogen sources can be replaced with the new and extremely performing LED technology. The LED module used in this fitting allows a significant lumen output with suitable colour temperature (3000K/2700K) and good chromatic output (CRI 90). Furthermore, this fitting does not require the use of bulky and aesthetically invasive power devices. Its sophisticated power supply system drastically reduces flickering effects reported in similar solutions involving the rectification of alternating current power supplies. Also it guarantees good efficiency levels and a lamp life expectancy equivalent to the LEDs in use.

Mesmeri LED

La nouvelle technologie d'alimentation à LEDs et l'emploi de LED spécifiques conçues pour être utilisées dans des circuits non SELV permet, pour la première fois, de substituer de façon transparente pour l'utilisateur, tant en termes de performances que de design, la désormais ancienne technologie des lampes halogènes avec la technologie beaucoup plus performante des LEDs. En effet, le module à LEDs utilisé permet de disposer d'une quantité significative de lumen, avec une température de couleur appropriée (3000K/2700K) et un bon rendu chromatique (CRI 90). En outre, son fonctionnement ne réclame pas l'emploi de dispositifs d'alimentation encombrants et invasifs esthétiquement parlant. Le très sophistiqué système d'alimentation adopté réduit radicalement les effets de clignotement présents dans des solutions analogues basées sur le redressement d'alimentation en courant alternatif. Il garantit une bonne efficacité et un cycle de vie comparable à celui des LED actuelles.

Mesmeri LED

Die neue LED-Versorgungstechnik und die Verwendung spezifischer LED, die für den Einsatz außerhalb des SELV-Bereiches entwickelt wurden, ermöglichen es dem Benutzer zum ersten Mal, die bewährte Halogentechnologie sowohl hinsichtlich Leistung als auch Design auf transparente Weise durch die wesentlich leistungsstärkere LED-Technologie zu ersetzen. Das verwendete LED-Modul gewährleistet eine signifikante Lumenzahl bei einer Farbtemperatur von 3000K/2700K und guter Farbwiedergabe (CRI 90). Außerdem erfordert diese LED keine unschönen und platzraubenden Netzgeräte. Das ausgeklügelte Versorgungssystem reduziert die Flacker-Effekte ähnlicher Lösungen, garantiert eine effiziente Leistung und eine mit herkömmlichen LEDs vergleichbare Lebenserwartung.

Mesmeri LED

Gracias a la nueva tecnología de alimentación LED y al uso de LED específicos, que se diseñaron expresamente para su uso en circuitos no SELV, por vez primera, es posible sustituir la madura tecnología de los halógenos por la tecnología LED, de prestaciones muy superiores. Al efecto, además, se puede proceder de manera transparente para con el usuario tanto por lo que se refiere a las prestaciones como al diseño. El módulo LED empleado, efectivamente, permite disponer de un paquete de lúmenes notable, con una temperatura del color adecuada (3000K/2700K) y un buen rendimiento cromático (IRC 90). Como si ello fuera poco, para funcionar no requiere dispositivos de alimentación de gran tamaño, que tanto merman la estética. El sofisticado sistema de alimentación aplicado reduce contundentemente los efectos de parpadeo o flicker, que se hallan en soluciones análogas, basadas en la rectificación de la alimentación eléctrica con corriente alterna. El mismo garantiza un buen nivel de eficiencia y unas expectativas de vida útil equivalentes a las de los LED instalados.

Materiali

Alluminio pressofuso verniciato, cromato o ramato.
Il diffusore della versione Halo è in vetro, mentre quello della versione LED è in policarbonato.

Materials

Die-cast aluminium painted or chromed.
The Halo version has a glass diffuser, whereas the LED version has a polycarbonate diffuser.

Matériaux

Aluminium galvanisé verni ou chromé.
Le diffuseur de la version Halo est en verre tandis que celui de la version LED est en polycarbonate.

Materialien

Lackierter oder verchromter Aluminiumdruckguss.
Der Diffuser der Halo-Version ist aus Glas und jener der LED-Version ist aus Polycarbonat.

Materialies

Aluminio comprimido pintado o cromado.
El difusor de la versión Halo es de vidrio, mientras que el de la versión LED es de policarbonato.



Awards

- 2002 – Prix “L’Observateur du Design 2002” “Etoile 2002” – Paris (France)
- 2002 – Reddot Design Award Essen (Deutschland)
- 2002 – iF Product Design Award Hannover (Deutschland)
- 2002 – Compasso d’Oro / ADI – Selezione Milano (Italia)

Light emission



Colour



White



Mirror



Silver grey



Copper satin



314 416

LED

LED



Copper satin

Materiali

Corpo in alluminio verniciato; testate di chiusura in alluminio pressofuso. Talo 60 è disponibile anche nella versione in alluminio cromato o ramato.

Specificità

Disponibile in quattro lunghezze a seconda della potenza della sorgente luminosa.

Materials

Body in painted aluminium; die-cast aluminium endpieces. Talo 60 is also available in the chromed or copper-plated aluminium version.

Specification

Available in four lengths depending by the voltage of the light source.

Matériaux

Corps en aluminium verni; embouts de finition en aluminium galvanisé. Talo 60 est également disponible dans la version en aluminium chromé ou cuivré.

Spécificité

Disponibile en quatre longueurs selon la puissance de la source lumineuse.

Materialien

Körper aus lackiertem Aluminium; Wandhalterung aus Aluminiumdruckguss. Die Leuchte Talo 60 ist zudem aus verchromtem Aluminium oder Kupfer erhältlich.

Spezifikation

Erhältlich in vier Größen mit unterschiedlicher Bestückung.

Materiales

Cuerpo de aluminio pintado; cabezales de cierre de aluminio comprimido. Talo 60 está disponible también en la versión de aluminio cromado o cobrizo.

Especificaciones

Disponibile en quatros longitudes, según la potencia de la fuente luminosa.

Light emission



Colour



White



Mirror



Silver grey
(only Talo 60)



Copper satin
(only Talo 60)

Awards

2002 – Prix “L’Observateur du Design 2002”
“Etoile 2002” – Paris (France)

2002 – Reddot Design Award
Essen (Deutschland)

2002 – iF Product Design Award
Hannover (Deutschland)

2002 – Compasso d’Oro / ADI – Selezione
Milano (Italia)



314 414

LED

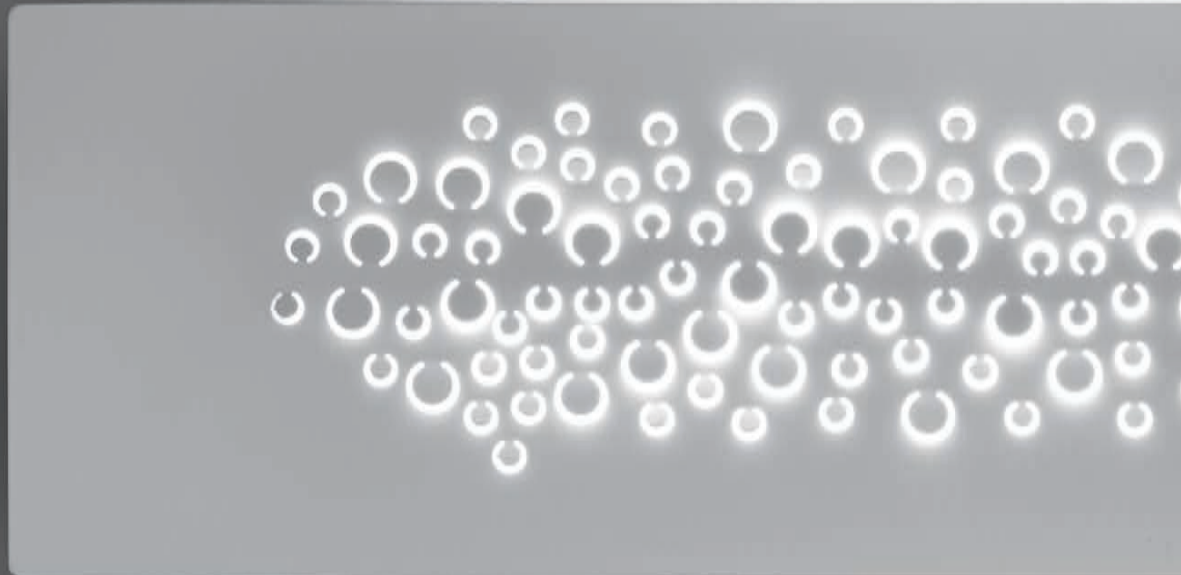

**Materiali**

Attacco a parete e griglia frontale in tecnopolimero, schermi superiore ed inferiore in tecnopolimero diffondente.

Specificità

Sul fronte tanti piccoli fori lasciano fuoriuscire la luce e la riflettono sulle piccole alette creata dalla piega del materiale.

Materials

Engineering plastic wall joint and grid; upper and lower engineering plastic screen diffusers.

Specification

Lots of tiny holes on the front let light through; this is reflected on the small fins created by the fold of the material.

Matériaux

Attache au mur et grille frontale en tecnopolymère, écran supérieur et inférieur en tecnopolymère diffusant.

Spécificité

Sur la partie frontale, de nombreux petits orifices laissent sortir la lumière et la reflètent sur les petites ailettes créées par le pli de la matière.

Materialien

Wandhalterung und Gitter vorne aus Technopolymer, obere und untere Abschirmungen aus diffundierendem Technopolymer.

Spezifikation

Auf der Vorderseite lassen viele kleine Löcher das Licht austreten und auf die kleinen Flügel reflektieren, die vom Knick des Materials erzeugt werden.

Materiales

Unión de pared y rejilla frontal de tecnopolímero, pantallas superior e inferior de tecnopolímero difusor.

Especificaciones

En la parte frontal muchos agujeros pequeños dejan salir la luz y la reflejan en las pequeñas alas que crea el pliegue del material.



LED



Light emission



Colours



Pirce wall
Pirce micro wall

Giuseppe Maurizio Scutellà
2010

Materiali

Alluminio verniciato.

Materials

Painted aluminium.

Matériaux

Aluminium peint.

Materialien

Lackiertes Aluminium.

Materiales

Aluminio pintado.



Light emission



Colour



Polished
white



Gold
(only micro LED)



Microsurf

Neil Poulton
2013

Un segno minimalista quasi impercettibile che si integra in qualunque contesto architettonico.

Materiali

Alluminio pressofuso verniciato.

A minimal, almost unobtrusive design to be integrated into any architectural setting.

Materials

Die-cast painted aluminium.

Microsurf est un signe minimaliste presque imperceptible qui s'intègre dans n'importe quel contexte architectural.

Matériaux

Aluminium galvanisé verni.

Minimalistisch, fast unmerklich: diese Leuchte integriert sich in fast jedes architektonische Umfeld.

Materialien

Lackiertes Aluminiumdruckguss.

Un signo minimalista casi imperceptible capaz de integrarse en cualquier contexto arquitectónico.

Materiales

Aluminio comprimido pintado.



Light emission



Colours



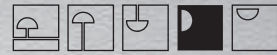

LED





Materiali

Alluminio pressofuso verniciato.

Specificità

Due dischi equivalenti assolvono la funzione di ancoraggio alla parete e alloggiamento del motore luminoso LED.

Materials

Die-cast painted aluminium.

Specifications

Two equivalent discs provide wall fixing and accommodate the LED lighting engine.

Matériaux

Aluminium galvanisé verni.

Spécificités

Deux disques équivalents font office d'ancrage au mur et de logement du moteur lumineux LED.

Materialien

Lackiertes Aluminiumdruckguss.

Spezifikation

Zwei äquivalente Scheiben dienen zur Befestigung an der Wand und zur Unterbringung des LED-Lichtmotors.



LED



Materiales

Aluminio comprimido pintado.

Especificaciones

Dos discos equivalentes cumplen la función de anclaje a la pared y sede del motor luminoso LED.

Awards

2014 – Reddot Design Award
High Design Quality
Essen (Deutschland)

Light emission



Colours



White

Materiali

Alluminio pressofuso verniciato.

Materials

Die-cast painted aluminium.

Matériaux

Aluminium moulé et peint.

Materialien

Lackiertes Aluminiumdruckguss.

Materialies

Aluminio fundido a presión.



Light emission



Colours





LED





Light emission



Colours



White



LED

Materiali

Alluminio pressofuso con finitura verniciata o cromata, staffa a parete in alluminio.

Specificità

In uno spessore assolutamente ridotto assicura un buon risultato nella distribuzione della luce nell'ambiente. Tigia può essere installata anche in modo da ottenere una illuminazione diretta anziché indiretta sempre garantendo un ottimo comfort di luce.

Materials

Painted or chromed die-cast aluminium, aluminium wall bracket.

Specification

Ensures a good light distribution performance with an ultra-thin structure.

Tigia can also be installed in view of direct, rather than indirect lighting for the same excellent lighting comfort.

Matériaux

Aluminium moulé sous pression finition vernie ou chromée, bride murale en aluminium.

Specificité

Dans une épaisseur absolument réduite, elle assure un bon résultat de distribution de la lumière dans l'espace.

Materialien

Aluminiumguss mit verchromtem oder lackiertem Finish, Wandbügel aus Aluminium.

Spezifikation

In einer absolut reduzierten Dicke gewährleistet sie bei der Lichtverteilung im Ambiente ein gutes Ergebnis. Tigia kann auch installiert werden, um bei stets bester Lichtqualität ein direktes anstatt indirektes Licht zu erzeugen.

Materiales

Aluminio fundido a presión con acabado pintado o cromado, estribo de pared de aluminio.

Especificaciones

En un espesor absolutamente reducido asegura un buen resultado en la distribución de la luz en el ambiente.

Tigia también se puede instalar con el fin obtener una iluminación directa en lugar de indirecta siempre asegurando un excelente confort de luz.

Melete

Pio & Tito Toso
2011

Materiali

Alluminio pressofuso verniciato.

Materials

Die-cast painted aluminium.

Matériaux

Aluminium moulé et peint.

Materialien

Lackierter Aluminiumdruckguss.

Materialies

Aluminio fundido a presión, pintado.

Light emission



Colours



White

Awards

2012 – Reddot Design Award
High Design Quality
Essen (Deutschland)



LED

LED

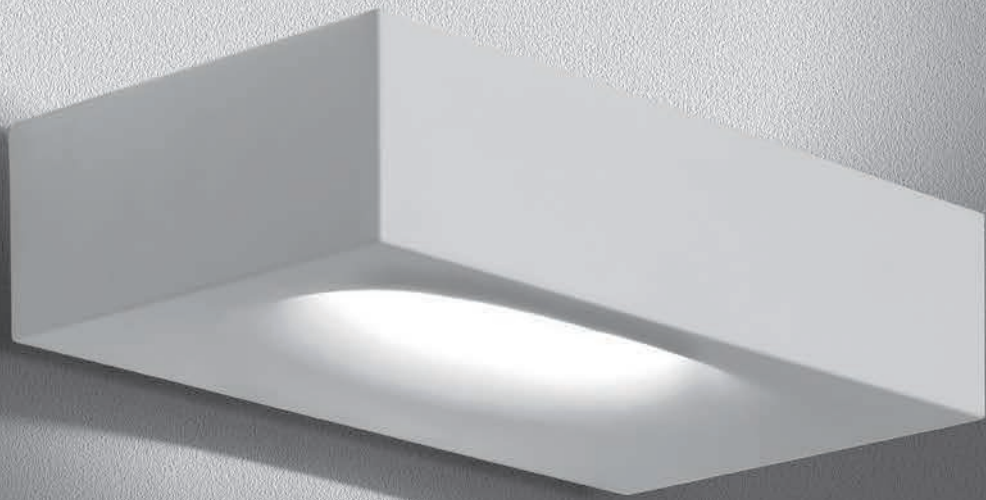

Materiali

Corpo in alluminio verniciato; supporto parete in alluminio pressofuso.

Materials

Painted aluminium body; die-cast aluminium wall support.

Matériaux

Corps en aluminium verni ; support applique en aluminium moulé.

Materialien

Gehäuse aus lackiertem Aluminium; Wandhalterung aus Aluminiumdruckguss.

Materiales

Cuerpo en aluminio pintado; soporte de aplique de aluminio fundido a presión.

Light emission



Colour



White



Materiali

Attacco parete e corpo lampada in alluminio pressofuso verniciato.

Materials

Wall support and body lamp in painted die-cast aluminium.

Matériaux

Support applique et corps en aluminium moulé sous pression peint.

Materialien

Wandhalterung und Leuchtenkörper aus druckgegossenem, lackiertem Aluminium.

Materiales

Soporte a pared y cuerpo de la lámpara en aluminio fundido a presión y pintado.

Light emission**Colours**

White



Materiali

Corpo lampada in materiale termoplastico stampato a iniezione; riflettore in alluminio ottico.

Materials

Body lamp in injection-moulded thermoplastic material; reflector in optic aluminium.

Matériaux

Corps en matériau thermoplastique moulé par injection ; réflecteur en aluminium à haut rendement.

Materialien

Reflektierender Leuchtenkörper aus Spritzguss-Thermoplast; Reflektor in Aluminium-Optik.

Materiales

Cuerpo de la lámpara en material termoplástico estampado a inyección; reflector en aluminio óptico.

Light emission**Colours**

Polished
white



Polished
back/white



LED

150

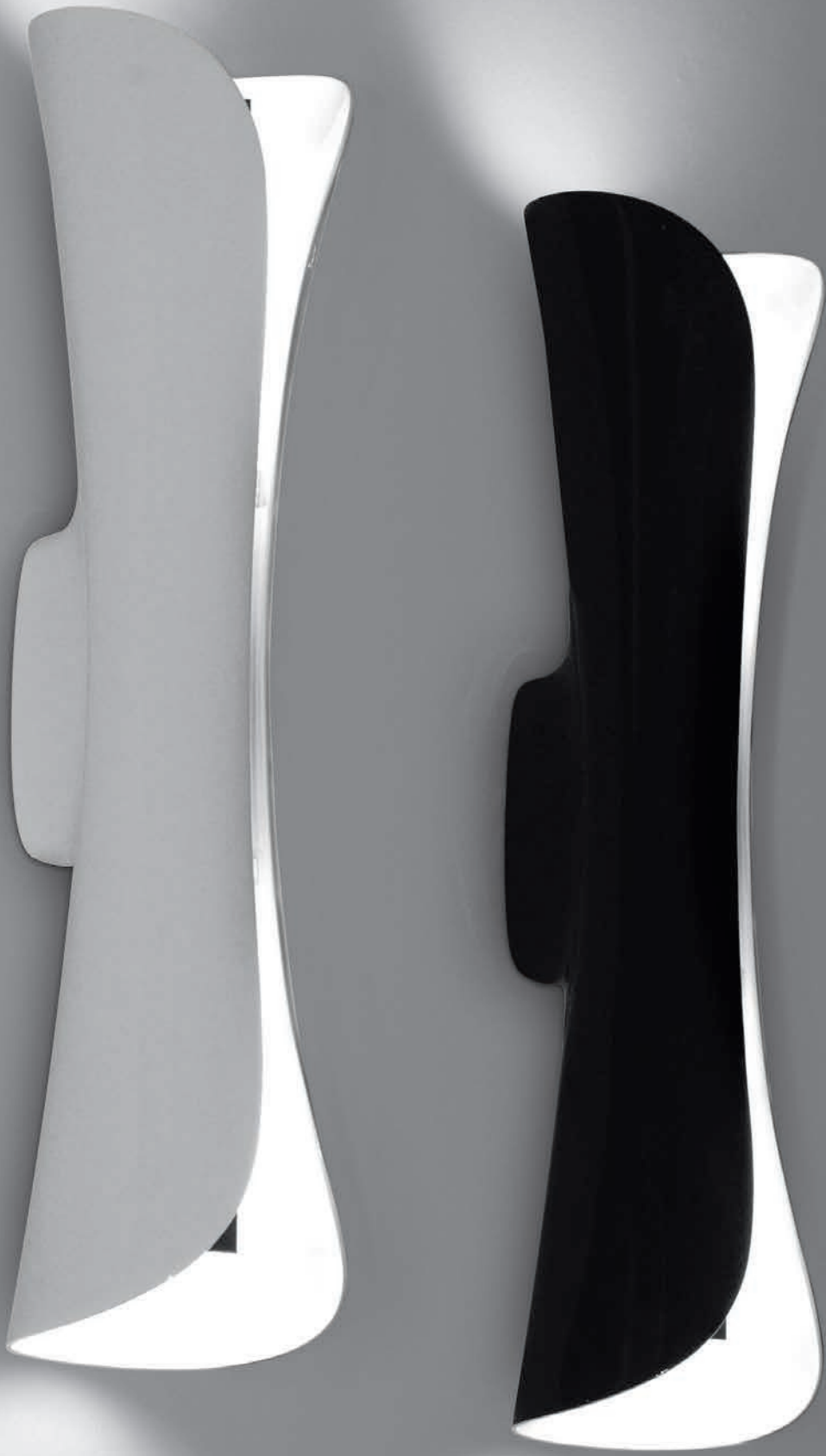

Melampo wall

Adrien Gardère
2003



Materiali

Attacco parete in alluminio verniciato; diffusore in raso di seta, supportato da tecnopolimero.

Specificità

Diffusore orientabile in due diverse posizioni.

Materials

Wall support in painted aluminium; diffuser in silk satin fabric on a technopolymer frame.

Specification

Diffuser adjustable into two different positions.

Matériaux

Support applique en aluminium peint ; diffuseur en technopolymère recouvert de satin de soie.

Spécificité

Diffuseur orientable dans deux positions.

Materialien

Sockel der Wandleuchte aus lackiertem Aluminium; Schirm aus Seidensatin (stabilisiert mit Technopolymer).

Spezifikation

Der Schirm ist in zwei unterschiedliche Positionen verstellbar.

Materiales

Soporte de applique de aluminio pintado; difusor en raso seda reforzado con tecnopolímero.

Especificaciones

Difusor orientable en dos posiciones diferentes.

Light emission



Colours

	Wall support: Grey
	Diffuser: Grey
	Wall support: Bronze
	Diffuser: Natural

Choose wall

Matteo Thun
2006

Materiali

Struttura in metallo verniciato; diffusore in policarbonato trasparente, accoppiato a un foglio di carta pergamena.

Specificità

Particolarmente indicate per le camere da letto.

Materials

Painted metal structure; diffuser in transparent polycarbonate, joined with parchment paper.

Specification

Fitting specifically designed for bedrooms, a diffused light.

Matériaux

Structure en métal verni, diffuseur en polycarbonate couplé à une feuille de papier parchemin.

Spécificité

Particulièrement destinée à la chambre à coucher.

Materialien

Lackierte Metallstruktur; Leuchtschirm aus Polycarbonat mit Pergamentpapier.

Spezifikation

Speziell beim Einsatz in Schlafzimmern schafft.

Materiales

Estructura metálica pintada; difusor de policarbonato, junto con tela de pergamino.

Especificaciones

Especialmente indicadas para dormitorios.

Light emission



Colours



Diffuser:
Transparent+Natural



Diffuser:
Transparent+White



La Petite wall

Andrea Quaglio
Manuela Simonelli
2016

Un archetipo paralume in equilibrio su uno stelo inclinato crea una bilanciata composizione geometrica che stupisce pur nella sua semplicità. Le forme elementari sono combinate a materiali diversi per ragioni tecnologiche.

Materiali

Struttura in alluminio, diffusore in metacrilato.

Specificità

Il paralume è un leggero volume plastico chiuso da due diffusori che producono una piacevole morbida luce diretta e indiretta.

An archetypal lampshade fitted on a tilted stem creates a surprising well-balanced, yet very simple geometric composition. Its basic forms are combined with a variety of materials for technological reasons.

Materials

Aluminium frame, methacrylate diffuser.

Specification

The lampshade is a lightweight plastic body closed by two diffusers that produce a pleasant soft direct and indirect light.

Un archétype d'abat-jour en équilibre sur une tige inclinée crée une position géométrique équilibrée qui surprend par sa simplicité. Ses formes élémentaires sont associées à des matières différentes pour des raisons technologiques.

Matériaux

Structure en aluminium, diffuseur en méthacrylate.

Spécificité

L'abat-jour est un léger volume plastique fermé par deux diffuseurs qui produisent une lumière douce et agréable, directe et indirecte.

Ein Archetyp des Lampenschirms auf einem geneigten Stab erzeugt eine ausgewogene geometrische Komposition, die trotz ihrer Einfachheit überrascht. Die Grundformen werden aus technischen Gründen mit verschiedenen Materialien kombiniert.

Materialien

Aluminiumstruktur, Diffusor aus Metacrylat.

Spezifikation

Der Lampenschirm besteht aus einem leichten Kunststoff-Volumen, geschlossen von zwei Diffusoren, die ein angenehm weiches direktes und indirektes Licht erzeugen.

Una pantalla arquetipo en equilibrio en un pie inclinado crea una composición geométrica equilibrada que sorprende a pesar de su sencillez. Las formas elementales están combinadas con materiales diferentes por razones tecnológicas.

Materiales

Estructura de aluminio, difusor de metacrilato.

Especificaciones

La pantalla es un ligero volumen plástico cerrado por dos difusores que producen una agradable y suave luz directa e indirecta.



Light emission



Colours



Black



White



Logico wall
Logico mini wall
Logico micro wall

Michele De Lucchi
Gerhard Reichert
2001





128



356



526



LED



Materiali

Struttura in metallo verniciato; diffusore in vetro soffiato con finitura seta lucida. Soffiatura a tre strati (cristallo + effetto seta + cristallo) in stampo a fermo con forma capovolta per garantire solidità strutturale del vetro.

Materials

Painted metal structure, blown glass diffuser with a polished-silk finish. Three layers of glass (crystal + silk + crystal) are blown in an upside down mould to ensure structural consistence to glass.

Matériaux

Structure en métal verni ; diffuseur en verre soufflé, finition soie brillante. Verre soufflé en trois couches (cristal + effet soyeux + cristal) dans un moule qui a une forme inversée pour garantir la solidité structurale du verre.

Materialien

Rahmen aus lackiertem Metall; Schirm aus geblasenem Glas in seidig glänzendem Finish. Drei Glasschichten (Kristall + Seide + Kristall) die umgekehrt positioniert sind um die Stabilität des Glases zu gewährleisten.

Materiales

Estructura de metal pintado; difusor de cristal soplado con acabado de seda brillante. Soplado a tres capas (cristal + efecto seda + cristal) en un molde con forma invertida para asegurar la resistencia estructural del cristal.



Grey diffuser



Tobacco diffuser

Light emission



Colours

Structure: Silver Grey

Diffuser: White

Diffuser: Tobacco

Diffuser: Grey

Awards

2002 – Design Innovationen
Design Zentrum Nordrhein Westfalen
Reddot Design Award
Essen (Deutschland)

Materiali

Policarbonato traslucido (versioni colorate) o in resina termoplastica (versione bianca).

Specificità

Possibilità di comporre configurazioni multiple.

Materials

Translucent polycarbonate (coloured version); thermoplastic resin (white version).

Specification

It is possible to create multiple configurations.

Matériaux

Polycarbonate translucide (versions colorées) ou en résine thermoplastique (version blanche).

Spécificité

Possibilité de créer de multiples applications.

Materialien

Farbige Ausführungen aus transluzentem Polycarbonat, weiße Ausführung aus Kunstharz.

Spezifikation

Die Vielzahl an Kombinations-möglichkeiten gestattet die Anwendung individueller Konfigurationen.

Materiales

Policarbonato traslúcido (versiones color) o de resina termoplástica (versión blanca).

Especificaciones

Posibilidad de componer configuraciones múltiple.

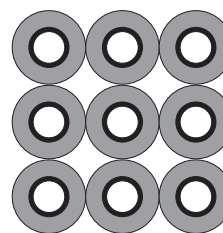
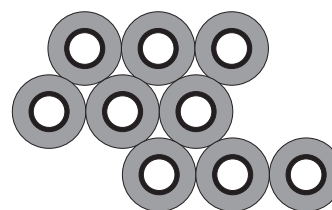
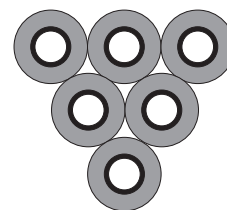

Configuration examples

Light emission**Colours**

Polished White



Transparent



Anthracite Grey



Transparent Orange



Demetra faretto

Naoto Fukasawa
2013

Materiali

Attacco parete e testa in pressofusione di alluminio con finitura verniciata.

Materials

Wall support, head and arms in painted die-cast aluminium.

Matériaux

Fixation murale et tête en aluminium moulé sous pression peint.

Materialien

Wandhalterung und Leuchtenkopf aus lackiertem Aluminium.

Materialies

Soporte pared y cabezal en aluminio comprimido pintado.



Awards

2014 - Design plus
Light+Building Award
Frankfurt (Deutschland)

Light emission



Colours

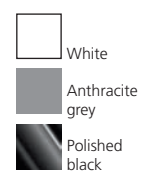



Demetra wall
Demetra micro wall
Demetra professional wall

Naoto Fukasawa
2013

Materiali

Attacco parete e testa in pressofusione di alluminio con finitura verniciata; bracci in estruso di alluminio.

Demetra Professional

In Demetra Professional le dimensioni si mantengono identiche alla versione classica ma il maggiore flusso emesso consente di ottenere illuminamenti elevati sul piano di lavoro. L'emissione è controllata da un riflettore che sporge leggermente dal profilo della testa.

Materials

Wall support, head and arms in painted die-cast aluminium; arms in extruded aluminium

Demetra Professional

While the size of Demetra Professional is the same as the classical version's, its enhanced emission flow provides intense lighting on the worktop. Emission is controlled by a reflector that slightly protrudes from the head's profile.

Matériaux

Fixation murale et tête en aluminium moulé sous pression peint; bras en aluminium extrudé

Demetra Professional

En ce qui concerne Demetra Professional, la taille est toujours identique à la version classique mais le débit de lumière plus fort permet d'obtenir un éclairage élevé sur le plan de travail. L'émission est contrôlée par un réflecteur qui dépasse légèrement du profil de la tête.

Awards

2014 - Design plus
Light+Building Award
Frankfurt (Deutschland)

Light emission



Colours



White



Anthracite grey



Polished black

Materialien

Wandhalterung und Leuchtenkopf aus lackiertem Aluminium; Arme aus fließgepresstem Aluminium.

Demetra Professional

Bei Demetra Professional sind die Maße die gleichen der klassischen Version, aber der größere emittierte Lichtstrom ermöglicht es, auf der Arbeitsfläche eine höhere Beleuchtungsstärke zu erhalten. Die Lichtemission wird von einem Scheinwerfer kontrolliert, der leicht aus dem Profil des Leuchtenkopfes ragt.

Materiales

Soporte pared y cabezal en aluminio comprimido pintado, brazos en aluminio extruido.

Demetra Professional

Demetra Professional tiene en mismo tamaño que la versión clásica pero el mayor flujo emitido permite obtener iluminaciones altas en la superficie de trabajo. La emisión es controlada por un reflector que sale ligeramente del perfil del cabezal.

Dimmer on top



Movement detector



MD Movement detector



12'



2,5 mt



Demetra Professional wall polished black



Demetra wall anthracite grey



Demetra wall white



Demetra micro

Demetra micro presenta in dimensioni più ridotte rispetto a Demetra la massima flessibilità di direzionare la luce nello spazio.

Demetra micro

Demetra micro is smaller than Demetra and ensures maximum flexibility to adjust light in space.

Demetra micro

Demetra micro présente avec une taille plus réduite par rapport à Demetra, la plus grande flexibilité pour diriger la lumière dans l'espace.

Demetra micro

Zeigt in den Tisch- und Wandversionen mit Arm mit einer geringeren Größe als Demetra höchste Flexibilität, das Licht im Raum auszurichten.

Demetra micro

Demetra micro mantiene todos los grados de libertad presentes en la versión tradicional, ofreciendo la máxima flexibilidad para dirigir la luz en el espacio.

Talak professional wall

Neil Poulton
2005

Materiali

Supporto parete in alluminio pressofuso; stelo in acciaio cromato lucido; corpo lampada in estruso di alluminio verniciato.

Specificità

Il corpo lampada ruota sul piano orizzontale ed è regolabile in altezza.

Materials

Wall support in diecast aluminium; polished chromed steel stem; painted aluminium extruded body.

Specification

The body lamp rotates on the horizontal plane and is adjustable in height.

Matériaux

Support applique en aluminium moulé ; tige en acier poli chromé, corps de la lampe en aluminium extrudé.

Spécificité

Le corps de la lampe s'oriente sur le plan horizontal et se règle en hauteur.

Materialien

Wandbefestigung aus Aluminium; Stab aus Stahl, Chrom poliert; Leuchtenkörper aus extrudiertem Aluminium.

Spezifikation

Der Leuchtenkörper kann horizontal gedreht werden und ist höhenverstellbar.

Materiales

Soporte pared en aluminio presofuso; tija en acero cromado brillante; cuerpo lámpara de aluminio extruido.

Especificaciones

El cuerpo de la lámpara gira en sentido horizontal y es regulable en altura.



Awards

2005 – "Observateur du Design" 2005
Etoile 2005 A.P.C.I. – Paris (France)

2006 – Design Innovationen Design Zentrum
Nordrhein Westfalen

2006 - Reddot Design Award – Product Design
"Best of the Best 2006"
Essen (Deutschland)

2008 – Compasso D'oro / A.D.I.
Segnalazione 2008 – Milano (Italia)

Light emission



Colours



Diffuser:
Polished white



Stem:
Mirror



Tolomeo wall
Tolomeo mini wall
Tolomeo micro wall
Tolomeo braccio

Michele De Lucchi
Giancarlo Fassina
1987



Materiali

Struttura a bracci mobili in alluminio lucidato; diffusore in alluminio anodizzato opaco o alluminio brillantato; snodi e supporto parete in alluminio brillantato.

Specificità

Sistema di equilibratura a molle.

Materials

Cantilevered arms in polished aluminium; diffuser in matt anodised or polished aluminium; joints and wall support in polished aluminium.

Specification

System of spring balancing.

Matériaux

Structure à bras articulés en aluminium poli; diffuseur en aluminium anodisé opaque ou aluminium brillant; rotules et support applique en aluminium brillant.

Spécificité

Système d'équilibrage à ressorts.

Materialien

Verstellbare Leuchtenarme aus glänzendem Aluminium; Leuchtenkopf aus matt eloxiertem oder poliertem Aluminium; Gelenke und Arm der Wandleuchte aus poliertem Aluminium.

Spezifikation

Mit Federausgleichsystem.

Materiales

Estructura de brazos móviles, de aluminio pulido; difusor de aluminio anodizado mate o brillante; articulaciones y soporte de pared, de aluminio brillante.

Especificaciones

Sistema de compensación dinámica de resortes.

Tolomeo braccio



Awards
Tolomeo wall
1989 – Compasso d’Oro / ADI
Milano (Italia)

Tolomeo LED
mini LED

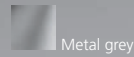

Tolomeo Braccio



Tolomeo micro LED



Tolomeo Halo,
mini Halo

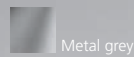

Tolomeo micro Halo

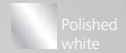
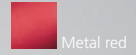
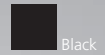
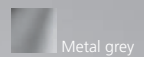

Light emission



Tolomeo wall

Tolomeo mini wall

Tolomeo faretto
Tolomeo micro faretto

Michele De Lucchi
Giancarlo Fassina
1995

Materiali

Supporto parete in alluminio lucidato; diffusore in alluminio anodizzato opaco.

Specificità

Disponibili con o senza interruttore.

Materials

Wall support in polished aluminium; diffuser in matt anodised aluminium.

Specification

Available with or without switch.

Matériaux

Support applique en aluminium poli ; diffuseur en aluminium anodisé opaque.

Spécificité

Disponible avec ou sans interrupteur.

Materialien

Sockel der Wandleuchte aus glänzendem Aluminium; Kopf aus matt eloxiertem Aluminium.

Spezifikation

Erhältlich mit oder ohne Schalter.

Materiales

Soporte de applique, de aluminio pulido; difusor de aluminio o anodizado mate.

Especificaciones

Disponible con interruptor o sin interruptor.

Light emission



Colours



Wall support:
Mirror



Diffusor:
Metal Grey

Patent Pending
n. 11161968.0

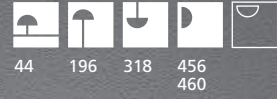

LED

LED



Tolomeo faretto with push button



Tolomeo micro faretto with push button

Tolomeo pinza
Tolomeo micro pinza

Michele De Lucchi
Giancarlo Fassina
1995



Materiali

Supporto in alluminio lucidato; diffusore in alluminio anodizzato opaco; pinza in acciaio.

Materials

Support in polished aluminium, diffuser in matt anodised aluminium; clip in steel.

Matériaux

Support en aluminium poli ; diffuseur en aluminium anodisé mat, pince en acier.

Materialien

Halterung aus poliertem Aluminium; Kopf aus matt eloxiertem Aluminium; Klemme aus Stahl.

Materiales

Soporte de aluminio pulido; difusor de aluminio anodizado mate; pinza de acero.

Awards

1996 – iF Product Design Award
Hannover (Deutschland)

1996 – “D’Excellence Marie-Claire Maison”
Paris (France)

Patent Pending

n. 11161968.0



44

196

318

456

458

LED

LED



Light emission



Tolomeo pinza



Metal grey

Tolomeo micro pinza



Metal grey

Metal orange
(halo version only)

Metal red
(halo version only)

Metal blue
(halo version only)

Tolomeo basculante wall

Michele De Lucchi
Giancarlo Fassina
2004

Materiali

Struttura a bracci mobili in alluminio lucidato; diffusore in carta pergamena o in raso di seta supportato da materiale plastico; supporto parete in alluminio brillantato.

Specificità

Il diffusore, nel normale utilizzo, si dispone verticalmente, indipendentemente dall'angolazione del braccio. Sistema di equilibratura a molle.

Materials

Cantilevered arms in polished aluminium; diffuser in parchment paper or in silk satin fabric on a plastic frame; wall support in polished aluminium.

Specification

The diffuser normally used, remains vertical regardless of the angle of the arm. System of spring balancing.

Matériaux

Structure à bras articulés en aluminium poli; diffuseur en papier parchemin ou en polycarbonate recouvert de satin de soie ; support applique en aluminium brillant.

Spécificité

Le diffuseur dans le cadre d'une utilisation normale, se place verticalement, indépendamment de la position du bras. Système d'équilibrage à ressorts.

Materialien

Ausrichtbare Arme aus glänzendem Aluminium; Schirm aus mit Kunststoff stabilisiertem Pergamentpapier oder Seidensatin; Wandhalterung aus poliertem Aluminium. Federausgleichsystem.

Spezifikation

Der Schirm steht normalerweise in vertikaler Position, unabhängig von der Ausrichtung des Armes. Federausgleichsystem.

Materiales

Base y estructura con brazos móviles de aluminio pulido; difusor en pergamino o en raso seda reforzado con plástico; articulaciones de aluminio pulido. Soporte aplique de aluminio pulido.

Especificaciones

En su uso normal, el difusor se dispone verticalmente, independientemente de la angulación del brazo. Sistema de equilibrado a muelles.

Light emission



Colours



Wall support and arms:
Mirror



Diffuser:
Natural



Diffuser:
Grey



Tolomeo mega wall

Michele De Lucchi
Giancarlo Fassina
2003



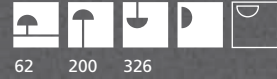

62 200 326

LED

LED

Materiali

Struttura a bracci mobili in alluminio lucidato; diffusore in carta pergamena, in raso di seta o in tessuto nero supportato da materiale plastico; supporto parete in alluminio brillantato.

Specificità

Diffusore disponibile in tre dimensioni, orientabile in tutte le direzioni. Sistema di equilibratura a molle.

Materials

Cantilevered arms in polished aluminium; diffuser in parchment paper, in silk satin or in black fabric on a plastic frame; wall support in polished aluminium.

Specification

Diffuser, available in three sizes, adjustable in all directions. System of spring balancing.

Matériaux

Structure à bras articulés en aluminium poli; diffuseur en papier parchemin, en polycarbonate recouvert de satin de soie gris ou noir ; support applique en aluminium brillant.

Spécificité

Diffuseur disponible en trois tailles, orientable dans toutes les directions. Système d'équilibrage à ressorts.

Materialien

Ausrichtbare Arme aus glänzendem Aluminium; Schirm aus mit Kunststoff stabilisiertem Pergamentpapier, Seidensatin oder schwarzem Gewebe. Wandhalterung aus poliertem Aluminium.

Spezifikation

Der Leuchtenkopf, erhältlich in drei Größen, lässt sich in alle Richtungen verstellen. Federausgleichsystem.

Materiales

Base y estructura con brazos móviles de aluminio pulido; difusor en pergamino, en raso seda o en tejido negro reforzado con plástico; articulaciones de aluminio pulido. Soporte aplique de aluminio pulido.

Especificaciones

Difusor disponible en tres tamaños, orientable en todas direcciones. Sistema de equilibrado a muelles.

Light emission



Colours



Wall support and arms: Mirror



Wall support and arms: Black



Diffuser: Natural



Diffuser: Black



Diffuser: Grey

Tolomeo diffusore 18, 24, 32 wall

Michele De Lucchi
Giancarlo Fassina
2006



Materiali

Braccio in alluminio lucidato; supporto parete in alluminio brillantato; diffusore in carta pergamena o in raso di seta supportato da materiale plastico.

Specificità

Il braccio presenta uno snodo che permette al diffusore di ruotare di circa 30° perpendicolarmente alla parete.

Materials

Arm and wall support in polished aluminium; diffuser in parchment paper or in silk satin fabric on a plastic frame.

Specification

The arm presents an articulation allowing the diffuser to tilt up to 30° perpendicular to the wall.

Matériaux

Bras en aluminium poli; support applique en aluminium brillant ; diffuseur en papier parchemin ou en polycarbonate recouvert de satin de soie.

Spécificité

Le bras est doté d'une articulation permettant au diffuseur de tourner d'environ 30° perpendiculairement au mur.

Materialien

Leuchtenarm aus hochglanzpoliertem Aluminium; Wandhalterung aus glänzendem Aluminium; Schirm aus mit Kunststoff stabilisiertem Pergamentpapier oder Seidensatin.

Spezifikation

Der Leuchtenarm ist mit einem Gelenk ausgestattet, das eine Drehung des Schirms um ca. 30° ermöglicht.



Materiales

Brazo de aluminio pulido; soporte de pared de aluminio brillante; difusor en pergamino o en raso seda reforzado con plástico.



Especificaciones

El brazo posee una articulación, merced a la cual el difusor logra girar a unos 30°, perpendicularmente a la pared.

Light emission



Colours

-  Wall support and arms: Mirror
-  Diffuser: Natural
-  Diffuser: Grey

Tolomeo 24 diffusore wall

Tolomeo 18 diffusore wall

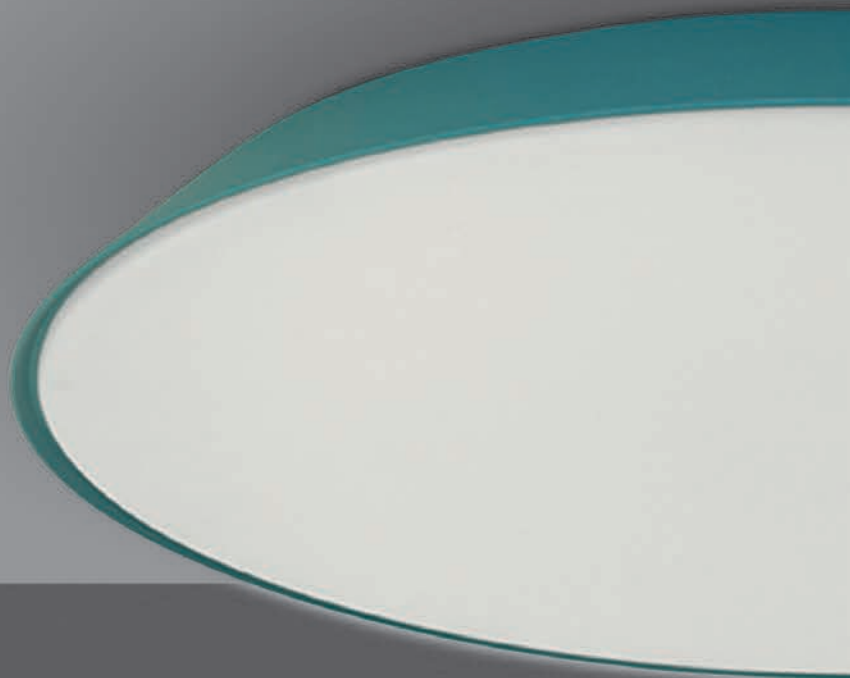

Light emission



Colours



Materiali

Corpo lampada in metacrilato stampato ad iniezione, diffusore in policarbonato stampato ad iniezione.

Specificità

Un uniforme disco di luce sporge dalla superficie del soffitto/parete, la cornice colorata arretra verso l'interno ed è percepibile solo dal fianco.

Materials

Injection moulded methacrylate body; injection moulded polycarbonate diffuser.

Specification

A uniform light disc protrudes from the ceiling/wall surface, the coloured frame moves back towards the inside and is only visible from the side.



LED

**Matériaux**

Corps de la lampe en méthacrylate moulée par injection, diffuseur en polycarbonate moulé par injection.

Spécificité

Un disque de lumière uniforme ressort de la surface du plafond/mur, le cadre coloré recule vers l'intérieur et n'est perceptible que du côté.

Materialien

Leuchtenkörper aus spritzgegossenem Metacrylat, Diffusor aus spritzgegossenem Polycarbonat.

Spezifikation

Eine gleichförmige Leuchtscheibe ragt aus der Decken-/Wandfläche, der farbige Rahmen weicht nach innen und ist nur von der Seite zu erkennen.

Materiales

Cuerpo lámpara de metacrilato moldeado por inyección, difusor de polycarbonato moldeado por inyección.

Especificaciones

Un disco de luz uniforme sobresale de la superficie del techo/pared, el marco colorido retrocede hacia el interior y es perceptible solo desde el costado.

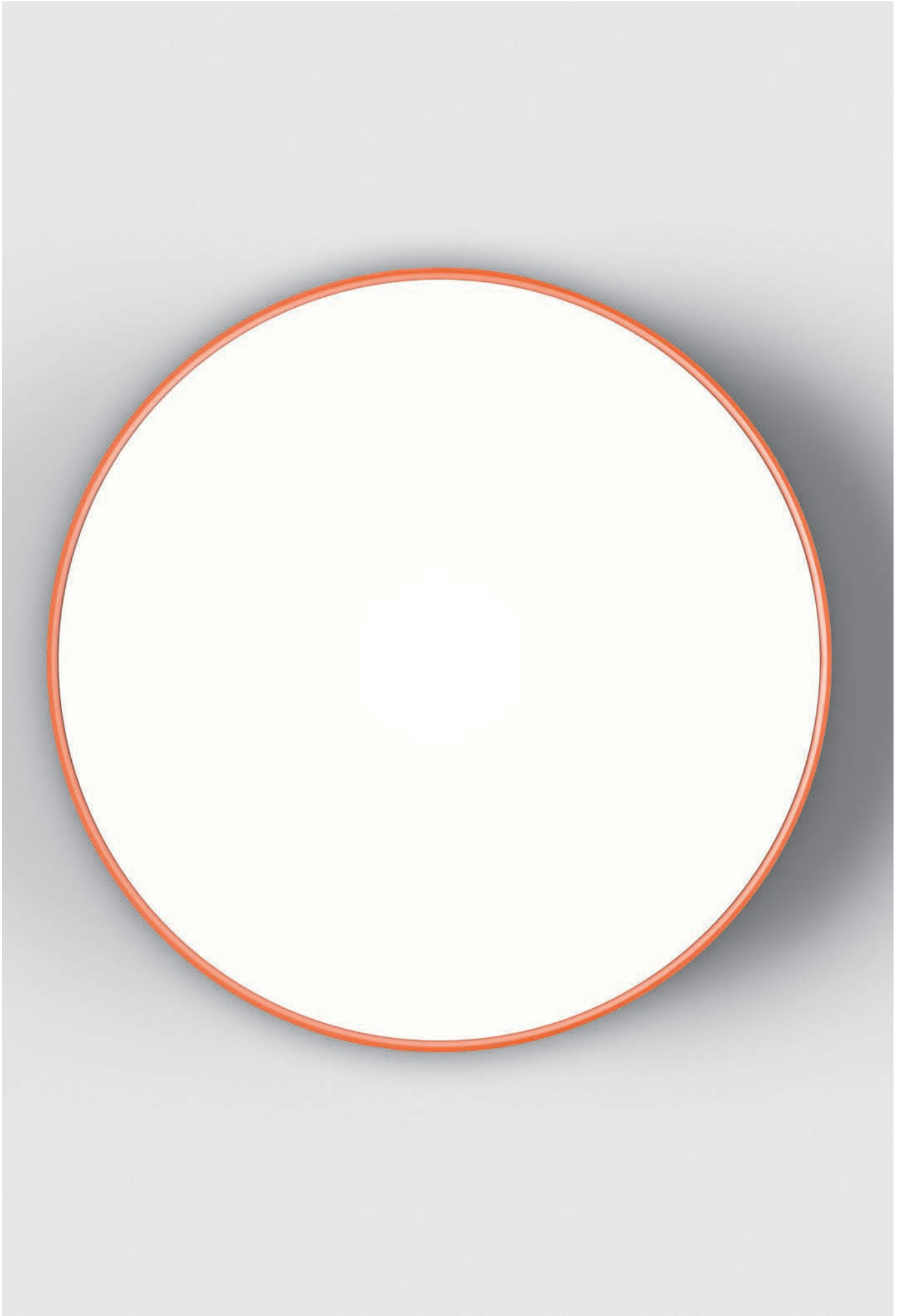

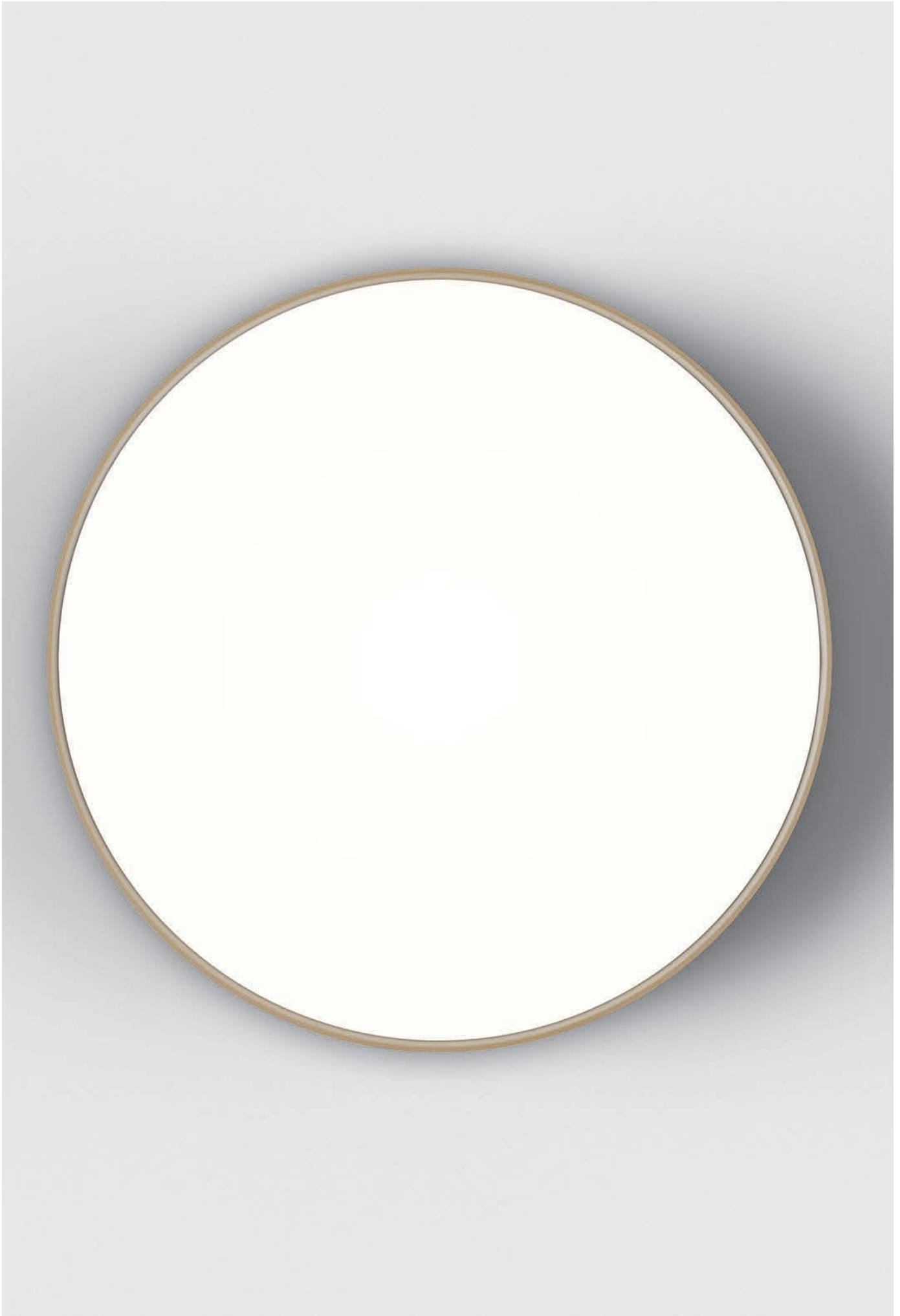





LED

“I vortici generati da uno script parametrico avanzato sono forme che catturano la luce, creando un fenomeno di emissione di luce grazie a un anello di LED disposti lungo la circonferenza. Può essere montato in gruppi singoli o multipli su pareti o soffitti”.

Materiali

Struttura in alluminio verniciato. Diffusore in materiale termoplastico.

“Light trapping vortices created through advanced parametric scripting are able to also radiate light thanks to a halo of LEDs fitted in the inner perimeter. It can be installed in single or multiple configurations, wall- or ceiling-mounted”.

Materials

Structure in painted aluminium; diffuser in othermoplastic material.

« Les tourbillons générés par un script paramétrique avancé sont des formes qui saisissent la lumière, en créant un phénomène d'émission de lumière grâce à un anneau de LED disposés sur la circonférence. Peut être monté en groupes simples ou multiples au mur ou au plafond ».

Matériaux

Structure en aluminium verni, diffuseur en matériau thermoplastique.

„Die aus Parametersätzen generierten Wirbel fangen das Licht ein, das von dem LED Ring am Rand der Leuchte abgegeben wird und erzeugen eine außergewöhnliche Lichtatmosphäre. Die Leuchte kann einzeln oder in Gruppen an der Wand oder Decke installiert werden“.

Materialien

Struktur aus lackiertem Aluminium. Diffusor aus thermoplastischem Material.

“Una leyenda paramétrica puntera genera vórtices que se convierten en formas destinadas a atrapar la luz. Así, se crea un fenómeno de emisión de luz, gracias a un anillo de LEDs que están ubicados a lo largo de la circunferencia. Se pueden montar en un solo grupo o en grupos múltiples, tanto en la pared como en el techo”.

Materiales

Estructura de aluminio pintado; difusor de material termoplástico.

Light emission



Colour



Structure:
Polished white



Diffuser:
White

Droplet mini

Ross Lovegrove
2015

Materiali

Corpo luminoso in alluminio pressofuso; riflettore in alluminio stampato e verniciato.

Materials

Die-cast aluminium lighting unit; painted die-cast aluminium reflector.

Matériaux

Corps lumineux en aluminium moulé sous pression.
Réflecteur en aluminium moulé et verni.

Materialien

Leuchtenkörper aus druckgegossenem Aluminium;
Reflektor aus formgestanztem Aluminium.

Materialies

Cuerpos luminosos en aluminio fundido a presión; reflector en aluminio moldeado y pintado.



Light emission



Colours







Materiali

Corpo della lampada in alluminio estruso, modellato meccanicamente; diffusore in policarbonato trasparente stampato ad iniezione; attacco alla parete in tecnopolimero verniciato.

Materials

Lamp body in extruded aluminum, mechanically moulded; transparent injection-moulded polycarbonate diffuser; wall support in technopolymer.

Matériaux

Corps en aluminium extrudé usiné; diffuseur en polycarbonate transparent moulé par injection; fixation murale en technopolymère

Materialien

Leuchtenkörper besteht aus fließgepresstem Aluminium; Der transparente Schirm aus Polycarbonat ist spritzgegossen; Wandhalterung und Leuchtenkopf aus Technopolymer.

Materiales

Cuerpo de la lámpara en aluminio extruido, modelado mecánicamente para obtener el efecto de textura que recuerda las formas de una llama; el difusor en policarbonato transparente moldeado por inyección.



Light emission



Colours

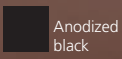

Awards

2014 - Design plus
Light+Building Award
Frankfurt (Deutschland)



Light emission



Colour



White



Red



Black



Gold
aluminium

Attraverso il minimo della presenza fisica determina un effetto sorprendente grazie ai giochi di luce ed ombra che crea.

Materiali

Alluminio verniciato e policarbonato.

Specificità

Il diffusore ruota a 358°.

With a minimal physical presence, it produces a surprising effect through the light and shadow contrasts it creates.

Materials

Painted aluminum and polycarbonate.

Specification

The diffuser spins 358°.



Par le minimum de sa présence physique, elle produit un effet surprenant grâce aux jeux de lumières et d'ombres qu'elle crée.

Matériaux

Aluminium peint et polycarbonate

Spécificité

Le diffuseur pivote à 358°.

Durch das Minimum an physischer Präsenz löst sie aufgrund der Spiele mit Licht und erzeugenden Schatten eine erstaunliche Wirkung aus.

Materialien

Lackiertem Aluminium und Polycarbonat.

Spezifikation

Der Kreis dreht sich zu 358°.

A través de una presencia física mínima, determina un efecto sorprendente gracias a los juegos de luces y sombras que crea.

Materiales

Aluminio pintado y policarbonato.

Especificaciones

El círculo gira en 358°.



Materiali

Attacco parete e testa in alluminio pressofuso con finitura verniciata.

Specificità

La sorgente LED è posta su un disco che si distanzia dalla parete per diffondere al meglio l'emissione indiretta che si differenzia nella versione a parete o soffitto. Il disco ruota sullo stelo che lo sostiene.

Materials

Die-cast aluminium wall joint with painted finish.

Specification

The LED source is fitted on a disc at a distance from the wall to ensure better indirect emission, which is different for the wall and the ceiling version. The disc rotates on the supporting stem.



LED

Matériaux

Attache au mur et tête en aluminium moulé sous pression avec finition vernie.

Spécificité

La source LED est placée sur un disque qui s'éloigne du mur pour diffuser au mieux l'émission indirecte qui se différencie dans la version au mur ou au plafond.

Le disque pivote sur la tige qui le soutient.

Materialien

Wandhalterung und Leuchtenkopf aus Aluminiumguss mit lackiertem Finish.

Spezifikation

Die LED-Lichtquelle befindet sich auf einer Scheibe, die sich im Abstand zur Wand befindet, um die indirekte Emission am besten zu verteilen, was sich von der Wand- oder Deckenversion unterscheidet. Die Scheibe dreht sich auf dem Stab, der sie trägt.

Materiales

Unión de pared y cabezal de aluminio fundido a presión con acabado pintado.

Especificaciones

La fuente LED está situada en un disco que se distancia de la pared para difundir de la mejor manera la emisión indirecta que se diferencia en la versión de pared o techo. El disco gira en el pie de soporte.



Light emission



Colours



White

Empatia 16, 26, 36 wall/ceiling

Carlotta de Bevilacqua
Paola di Arianello
2013

Materiali

Corpo della lampada in alluminio pressofuso con finitura verniciata; diffusore in vetro soffiato trasparente con finitura seta lucida; guida luce in metacrilato a basso coefficiente di assorbimento.

Materials

Painted die-cast aluminium body lamp; diffuser in blown glass with a polished-silk finish; light pipe made of low absorption coefficient methacrylate.

Matériaux

Corps en aluminium moulé sous pression peint ; diffuseur en verre soufflé transparent avec finition soie brillante ; guide lumière en méthacrylate à bas coefficient d'absorption.

Materialien

Leuchtenkörper aus druckgegossenem, lackiertem Aluminium; Schirm aus transparentem, mundgeblasenem Glas in seidig glänzendem Finish; Lichtstab aus Methacrylat mit niedrigem Absorptionskoeffizienten.

Materialies

Cuerpo de la lámpara en aluminio fundido a presión y pintado; difusor en cristal soplado transparente con acabado seda lúcido; guía de luz en metacrilato de bajo coeficiente de absorción.

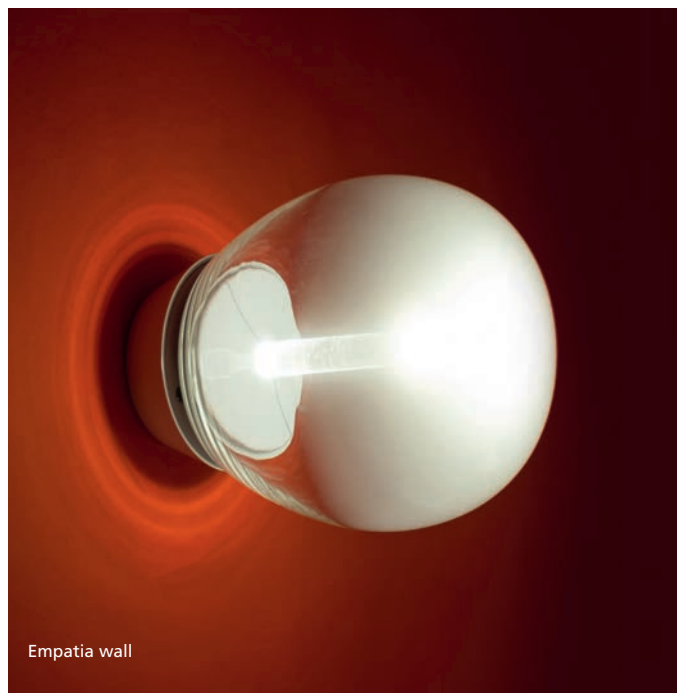

Light emission



Colours



White

Awards

2014 – Wallpaper Design Awards
2014 – iF Product Design Award



114 184 338

LED



Photo by Pierpaolo Ferrari, 2016



Empatia 26

Meteorite 15, 35 wall/ceiling
Meteorite 48 ceiling

Pio & Tito Toso
2014

Materiali

Diffusore in vetro soffiato; corpo della lampada in tecnopolimero.
Il corpo della Meteorite 15 è in alluminio.

Materials

Blown glass diffuser; lamp body in technopolymer.
Meteorite 15 features an aluminium body.

Matériaux

Diffuseur en verre soufflé ; corps en techno-polymère.
Le corps de la Météorite 15 est en aluminium.

Materialien

Schirm aus mundgeblasenem Glas; Leuchtenkörper aus
Technopolymer. Der Leuchtenkörper von der Meteorite 15
ist aus Aluminium.

Materiales

Difusor en cristal soplado, cuerpo de la lámpara en
tecnopolímero. El cuerpo de la Meteorite 15 es de aluminio.



Light emission



Colours



White

Meteorite 15



120
122

186

340

LED

LED

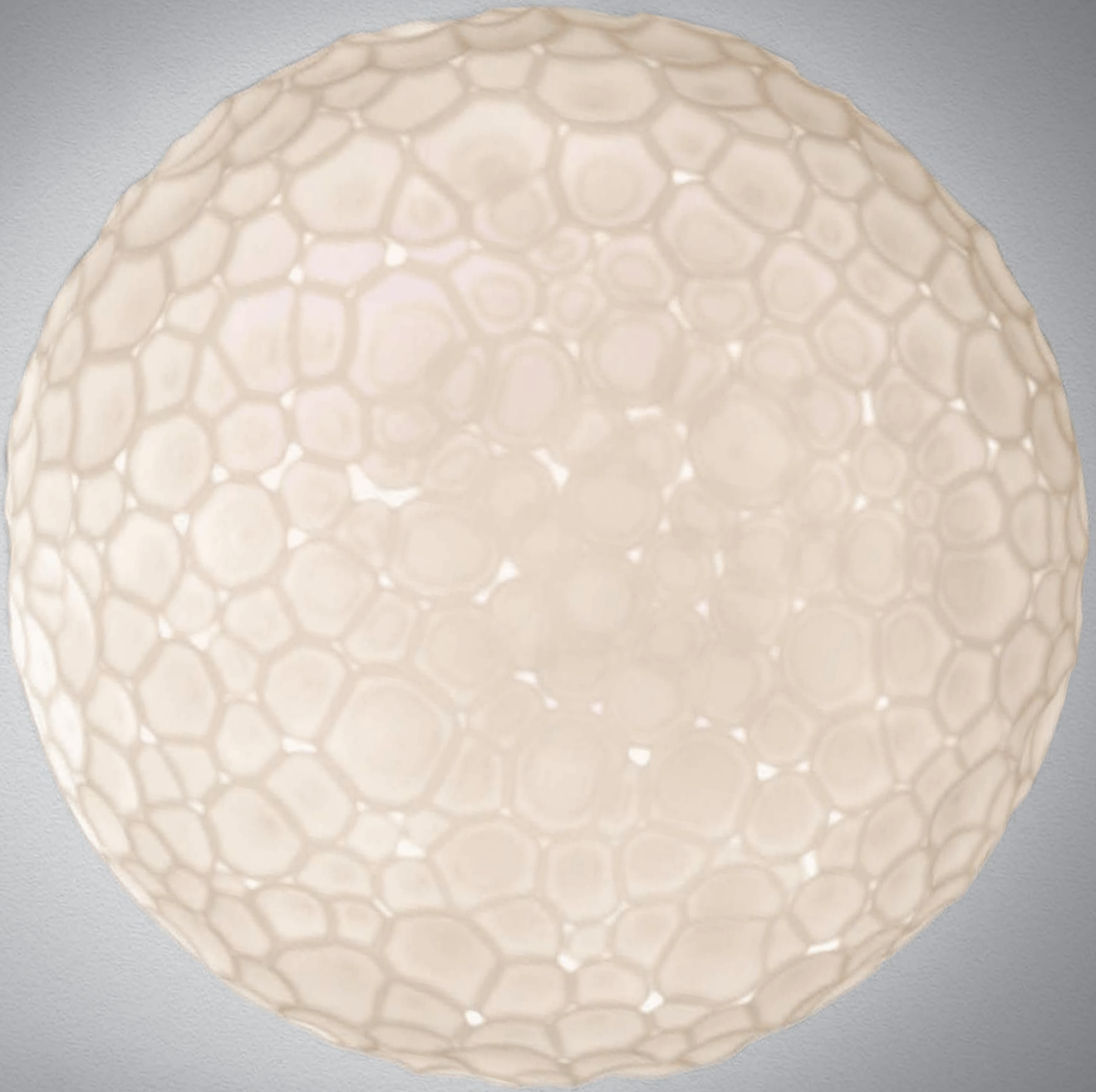



Meteorite 35



Meteorite 15



Meteorite 48

Dioscuri 14, 25, 35, 42 wall/ceiling

Michele De Lucchi
1999

Materiali

Supporto parete/soffitto in resina termoplastica; diffusore in vetro soffiato acidato.

Specificità

Il grado di protezione IP65 le rende idonee all'utilizzo anche in esterno.

Materials

Thermoplastic resin ceiling support; acid-etched blown glass diffuser.

Specification

IP65 rating makes it suitable also for outdoor use.

Matériaux

Support en matériau thermoplastique ; diffuseur en verre soufflé traité à l'acide.

Spécificité

L'indice de protection IP 65 permet l'installation de l'appareil en extérieur.

Materialien

Deckenbefestigung aus thermoplastischem Harz; Kugel aus mundgeblasenem, geätztem Glas.

Spezifikation

Auch in Außenbereichen einsetzbar (Schutzart IP65).

Materiales

Soporte de resina termoplástica; difusor de cristal soplado al ácido.

Especificaciones

El grado de protección IP65 la hace idónea para exteriores.

Light emission



Colours



White

Awards

2000 – Design Innovationen
Design Zentrum Nordrhein Westfalen
Reddot Design Award
Essen (Deutschland)
2000 – Design Plus Light + Building
Frankfurt am Main (Deutschland)



126

LED



Dioscuri 25

Dioscuri 35

Dioscuri 14

Dioscuri 42

Miconos wall Miconos ceiling

Ernesto Gismondi
1999

Materiali

Struttura in metallo cromato lucido; diffusore in vetro soffiato trasparente.

Materials

Structure in polished chromed metal, diffuser in transparent blown glass.

Matériaux

Structure en métal chromé brillant, diffuseur en verre soufflé transparent.

Materialien

Struktur aus poliertem und verchromtem Metall, Schirm aus klarem, mundgeblasenem Glas.

Materiales

Estructura, de metal cromado brillante; difusor en cristal soplado transparente.



Light emission



Colours



Structure:
Mirror



Diffuser:
Transparent



Materiali

Struttura in alluminio; corpo e schermo diffusore in tecnopolimero stampato a iniezione.

Specificità

Attorno all'ampia superficie diffondente disegna una cornice trapezoidale che sporge nello spazio. Cornice e supporto retrostante sono realizzati in toni giustapposti o contrapposti per definire con semplicità un carattere nettamente distinto, più neutro o decisamente d'impatto.

Materials

Aluminium frame; injection-moulded engineering-plastics body and screen diffuser.

Specification

Designs a trapezoid frame around the broad diffusing surface, protruding into space; both the frame and the rear support feature juxtaposed or opposite hues to simply define a dual character, either neutral or definitely high-impact.

Matériaux

Structure en aluminium ; corps et écran diffuseur en technopolymère moulé par injection.

Spécificité

Autour de la grande surface diffusante, elle trace un cadre trapézoïdal qui ressort dans l'espace. Le cadre et le support arrière sont réalisés en tonalités juxtaposées ou opposées afin de définir simplement un caractère nettement distinct, plus neutre ou décidément d'un fort impact.

Materialien

Leuchtenstruktur aus Aluminium; Leuchtenkörper und Abschirmungs-Diffusor sind aus Spritzguss-Tecnopolymer.

Spezifikation

Sie zeichnet um die große diffundierende Fläche einen trapezförmigen Rahmen, der in den Raum ragt. Der hintere Rahmen und die Halterung sind aus einfachen oder entgegengesetzten Farbtönen hergestellt, um einfach einen im Wesentlichen eigenen, neutraleren oder wirkungsvollen Charakter zu definieren.

Materiales

Estructura de aluminio; cuerpo y pantalla difusora de tecnopolímero moldeado por inyección.

Especificaciones

Alrededor del amplia superficie difusora dibuja un marco trapezoidal que sobresale en el espacio. El marco y el soporte trasero se han realizado en colores yuxtapuestos o contrapuestos para definir con sencillez un carácter netamente distinto, más neutro o marcadamente de impacto.

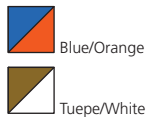
Light emission**Colours**



Altrove LED

Carlotta de Bevilacqua
2008

Materiali

Struttura perimetrale in alluminio a specchio; diffusori laterali in Prismoptic satinato; diffusore frontale in metacrilato trasparente inciso.

Materials

Perimeter structure made of mirrored aluminium; side diffusers made of satin Prismoptic; front diffuser in engraved transparent methacrylate.

Matériaux

Périmètre de la structure en aluminium ; diffuseurs latéraux en Prismoptic opalin ; diffuseur frontal en méthacrylate transparent strié.

Materialien

Rahmen aus verspiegeltem Aluminium; seitliche Reflektoren mit opaliner Prismoptic; Frontscheibe aus transparentem, graviertem Metacrylat.

Materialies

Estructura perimetral de aluminio, difusores laterales de Prismoptic opalino, difusor frontal de metacrilato transparente.

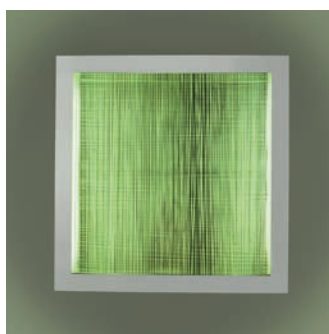
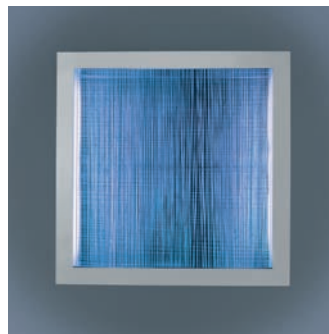
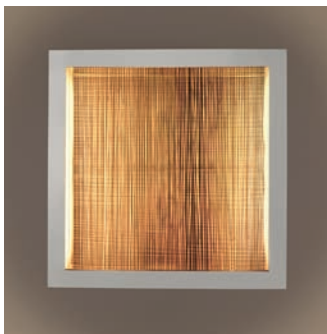

Light emission



Colour



Radiofrequency
remote control
(included)



LED

278

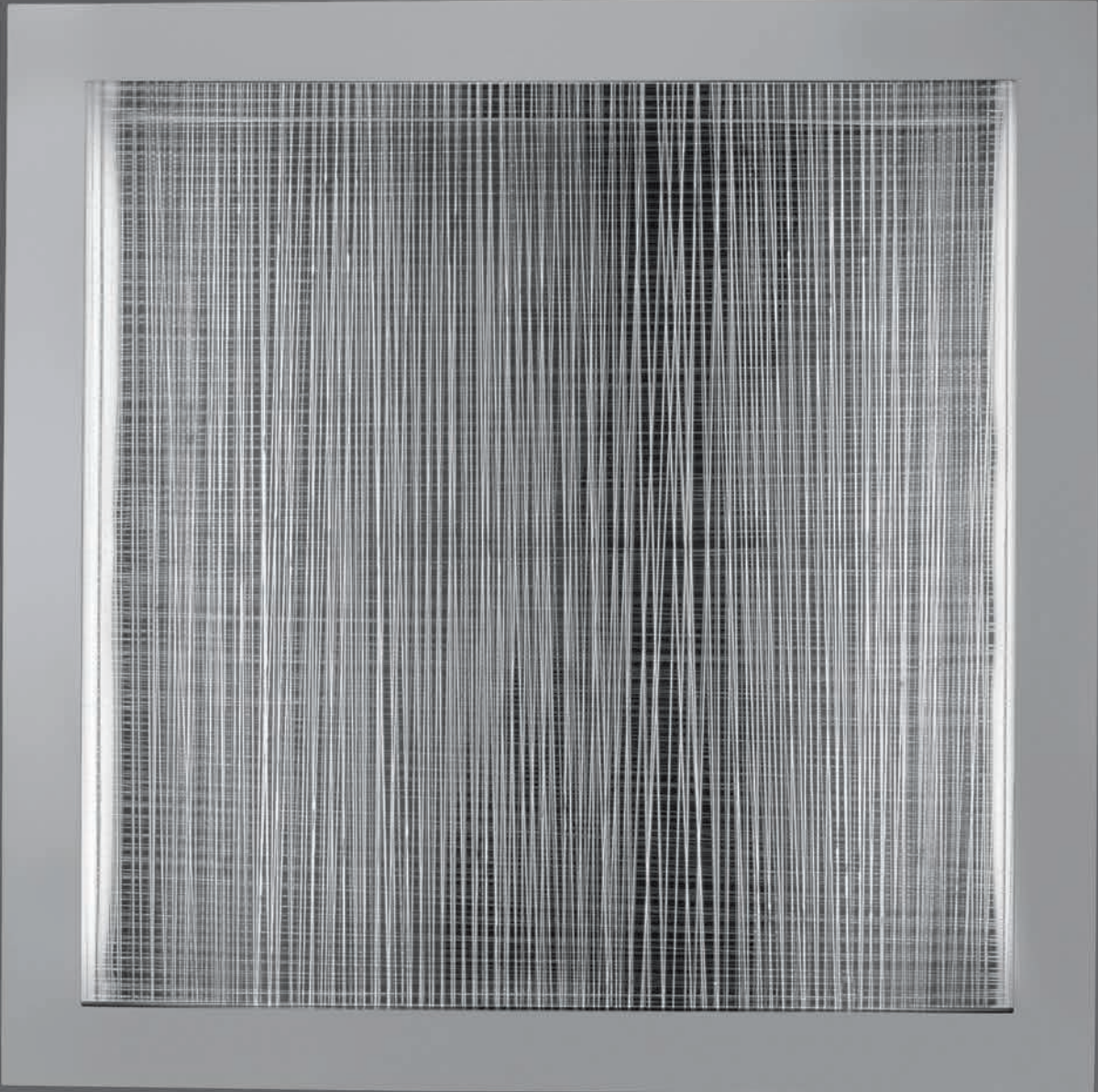

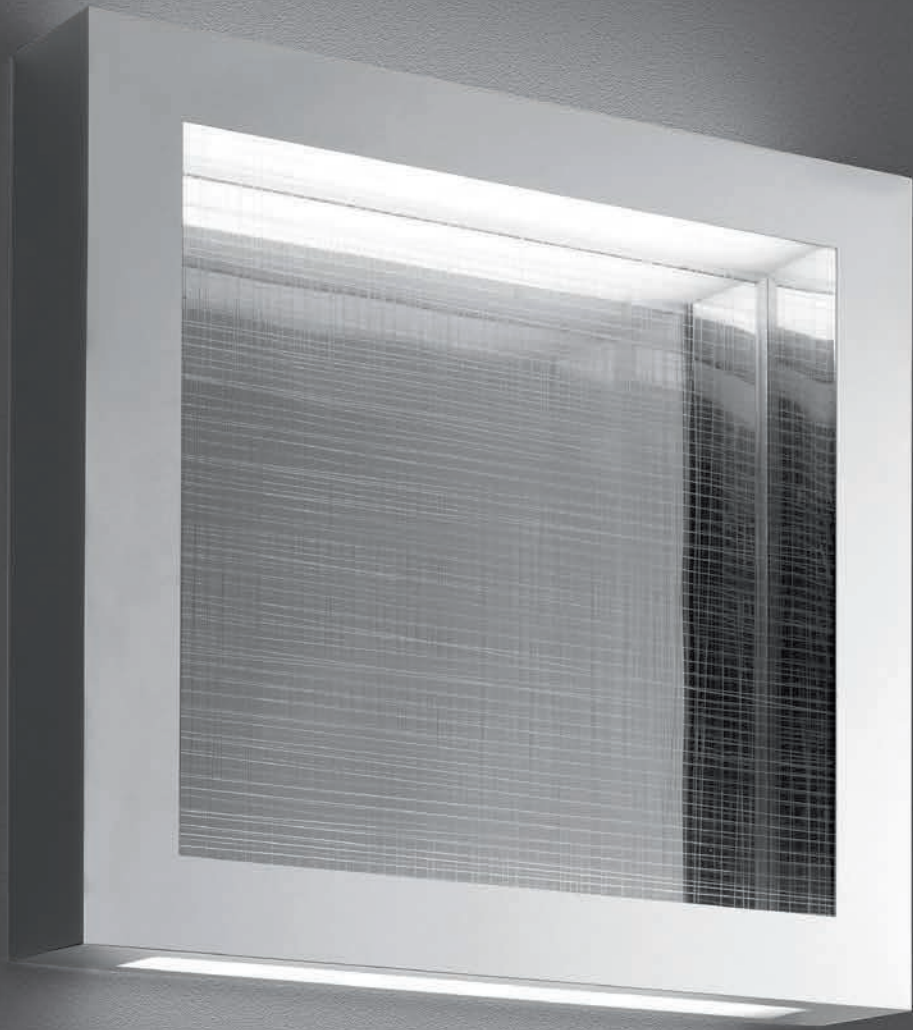

Materiali

Struttura perimetrale in acciaio inox a specchio; diffusori laterali in Prismoptic satinato; riflettore in alluminio lucido a specchio; diffusore frontale in metacrilato trasparente inciso.

Specificità

Due aperture lungo due lati opposti della struttura perimetrale permettono di ottenere anche un'emissione wall washer sulla parete.

Materials

Perimeter structure made of mirrored aluminium; side diffusers made of satin Prismoptic; front diffuser in engraved transparent methacrylate.

Specification

Two gaps along opposite sides of the perimeter structure create a wall washer emission on the wall.

Matériaux

Structure périmétrale en acier inoxydable miroitant, diffuseurs latéraux Prismoptic satiné ; réflecteur en aluminium poli et miroitant ; diffuseur frontal en méthacrylate transparent gravé.

Spécificité

Sur les deux côtés opposés de la structure périmétrale, deux ouvertures permettent également d'obtenir une émission wall washer sur le mur.

Materialien

Rahmen aus verspiegeltem Edelstahl; seitliche Reflektoren mit opaliner Prismoptic; Frontscheibe aus transparentem, gravierten Metacrylat.

Spezifikation

Auf den beiden entgegengesetzten Seiten des Rahmens schaffen zwei Öffnungen einen auf die Wand gerichteten Wall Washer-Effekt.

Materiales

Estructura perimétrica de acero inoxidable con acabado espejo. Difusores laterales de Prismoptic satinado. Reflector de aluminio brillante con acabado espejo. Difusor frontal de metacrilato transparente grabado.

Especificaciones

Dos aberturas, a lo largo de dos lados opuestos de la estructura perimétrica, permiten obtener asimismo un efecto baño de luz contra los paramentos.

Light emission



Colour



Mirror

Edge 21, 30 wall/ceiling

Alessandro Mendini

2004

Materiali

Supporto parete in policarbonato e acciaio; diffusore in materiale termoplastico.

Specificità

Il grado di protezione IP65 la rende idonea all'utilizzo anche in esterno.

Materials

Wall support in polycarbonate and steel ; rotationally moulded technopolymer diffuser.

Specification

IP65 rating makes it suitable also for outdoor use.

Matériaux

Support applique in polycarbonate et acier; diffuseur en technopolymère roto-moulé.

Spécificité

L'indice de protection IP65 permet l'installation de l'appareil en extérieur.

Materialien

Wandhalterung aus Polycarbonat mit Stahlballast; Leuchtenkopfs aus Technopolymer hergestellt im Rotations-spritzgussverfahren.

Spezifikation

Durch Schutzart IP65 auch im Außenbereich einsetzbar.

Materiales

Soporte aplique en polycarbonato y acero; difusor de polímero trabajado mediante moldeo rotacional.

Especificaciones

El grado de protección IP65 la hace idónea para exteriores.

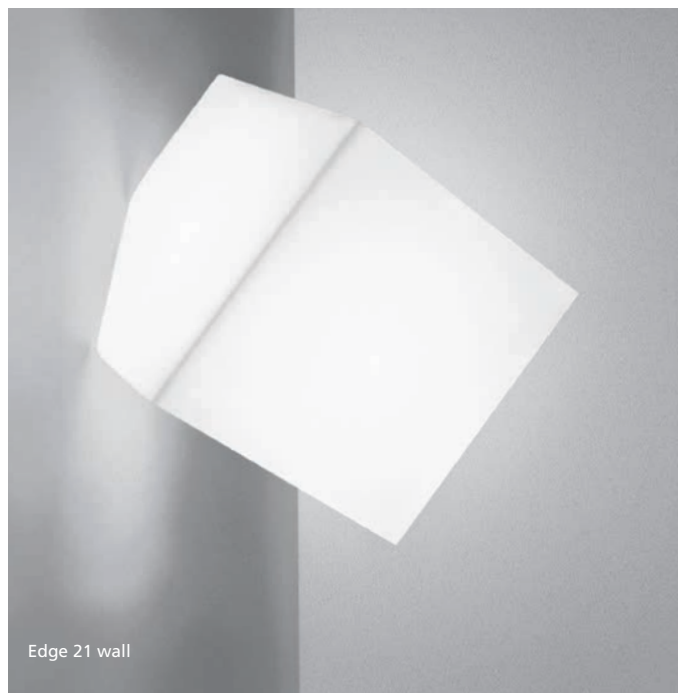

Light emission



Colours





370

LED



Edge 30 ceiling

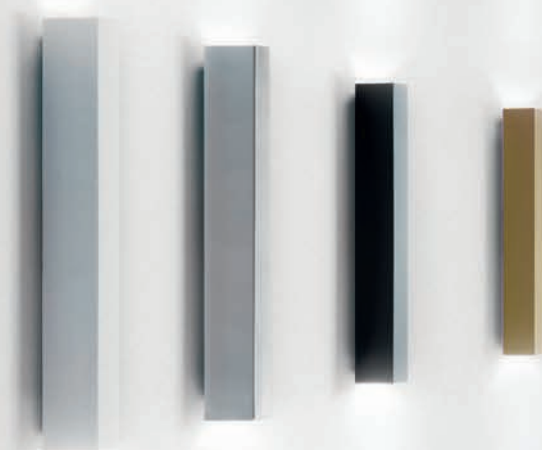

Light emission



Colours



White



Aluminium



Black



Brass



Red



Orange

Miyako è un sistema completo e diversificato per tipologie, performance di luce e varietà di colori disponibili, capace di creare scenografiche composizioni o di inserirsi con discrezione in qualsiasi ambiente garantendo ottime prestazioni luminose. Miyako si declina nella versione a plafone con emissione solo diretta e a parete con doppia emissione.

Materiali

Alluminio spazzolato, alluminio verniciato, metacrilato.

Miyako is a complete system with different solutions according to light performance and type, and to the various colours available: it can create spectacular effects or integrate gently in any environment, guaranteeing excellent light performance. Miyako is available in ceiling mounted version with a direct emission and wall version featuring either direct and indirect emission.

Materials

Brushed aluminum, painted aluminium, methacrylate.



LED

308



Miyako est un système complet et diversifié par typologies, performances de lumière et variétés de couleurs disponibles, en mesure de créer des compositions scénographiques ou de s'insérer avec discrétion dans n'importe quel milieu en garantissant de très bonnes performances de lumière. Miyako se décline en plafond avec émission directe seulement et paroi à double émission.

Matériaux

Aluminium brossé, aluminium peint, methacrilate.

Miyako ist ein vollständiges System, dessen Ausführung sich durch Aufbau, Lichtleistung und verfügbare Farbvielfalt unterscheidet. Es schafft bühnenhafte Kompositionen oder fügt sich diskret in jede Umgebung ein, wobei es ausgezeichnete beleuchtungstechnische Leistungen gewährleistet. Jeder dieser Körper ist als Wandausführung mit doppelter Emission erhältlich.

Materialien

Gebürstetem Aluminium, lackiertes Aluminium, Metacrylat.

Miyako es un sistema completo con diferentes soluciones según el rendimiento y el tipo de luz, y a los diversos colores disponibles: capaz de crear efectos espectaculares o integrarse sutilmente en cualquier ambiente, garantizando óptimos rendimientos lumínicos. Miyako está disponible en la versión de de plafón con emisión directa y en la versión aplique con doble emisión.

Materiales

Aluminio cepillado, aluminio pintado, metacrilato.



Gioca sulla destrutturazione del profilo di base, la luce proiettata attraverso gli anelli in equilibrio disegna sottili ombre nella definizione di una perfetta qualità di luce nello spazio.

Materiali

Alluminio anodizzato.

Featuring a deconstructed base profile, the light projected through the balanced rings designs subtle shadows while defining a perfect quality of light in space.

Materials

Anodized aluminum.

Elle joue sur la déstructuration du profil de base ; la lumière projetée à travers les anneaux en équilibre dessine de fines ombres pour la définition d'une qualité parfaite de la lumière dans l'espace.

Materiaux

Aluminium anodisé.

Sie spielt mit der Destrukturierung vom Basisprofil. Das durch die ausgeglichenen Ringe projizierte Licht zeichnet dünne Schatten in der Definition einer perfekten Lichtqualität in den Raum.

Materialien

Aluminium eloxiert.

Juega con la desestructuración del perfil de base, la luz proyectada a través de los anillos en equilibrio diseña sombras finas en la definición de una calidad perfecta de la luz en el espacio.

Materiales

Aluminio anodizado.

Light emission



Colour







Materiali

Corpo della lampada in alluminio estruso modellato meccanicamente.

Specificità

Le due differenti dimensioni del corpo cilindrico corrispondono a diverse performance di luce.

Materials

Milled aluminium extruded body.

Specification

The two different sizes of the cylinder-shaped body correspond to different lighting performances

Matériaux

Corps de la lampe en aluminium extrudé fraisé.

Spécificité

Les deux différentes dimensions du corps cylindrique correspondent à différentes performances de lumière

Materialien

Leuchtenkörper aus gefrästem, extrudiertem Aluminium.

Spezifikation

Die zwei verschiedenen Größen vom zylindrischen Körper entsprechen verschiedenen Lichtleistungen

Materiales

Cuerpo lámpara de aluminio extruido fresado.

Especificaciones

Los dos diferentes tamaños del cuerpo cilíndrico corresponden a rendimientos de luz distintos.



166 274



Light emission



Colours

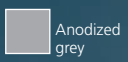
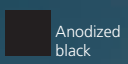

Lampada dedicata alla luce puntuale per gli ambienti, oltre a essere un elemento grafico nello spazio.

Materiali

Alluminio verniciato.

Specificità

Un cilindro leggerissimo fissato al soffitto, racchiude all'estremità inferiore una sorgente LED regolata da apposite lenti che controllano il fascio di emissione garantendo una luce puntuale e allo stesso tempo morbida.

losif is an indoor light fitting producing accent lighting, as well as being a graphic element in space.

Materials

Painted aluminium.

Specification

A ceiling-mounted, ultra-light painted aluminium cylinder with an LED source at its lower end, which is controlled by special lenses adjusting the light emission and ensuring a focused, soft beam.

losif est une lampe dédiée à la lumière ponctuelle, en plus d'être un élément graphique dans l'espace.

Matériaux

Aluminium verni.

Spécificités

C'est un cylindre très léger fixé au plafond qui contient à l'extrémité inférieure une source LED réglée par le biais de lentilles spéciales gérant le faisceau d'émission et garantissant ainsi une lumière ponctuelle et douce.

Eine Leuchte, die als fokussierter Punktstrahler und grafisches Element im Raum gleichermaßen fungiert.

Materialien

Lackiertes Aluminium

Spezifikation

Ein ultraleichter Zylinder zur Montage an der Decke umschließt am unteren Ende eine LED-Lichtquelle. Die speziellen Linsen gewährleisten fokussiertes und dennoch weiches Licht.

Lámpara de luz puntual para los distintos ambientes, así como un elemento gráfico en el espacio.

Materiales

Aluminio pintado.

Especificaciones

Un cilindro de aluminio pintado ultraligero sujeto al techo encierra una fuente LED en su extremo inferior, controlado por lentes especiales que actúan sobre la emisión, asegurando una luz concentrada pero suave al mismo tiempo.

Light emission



Colours



Red



LED



La parabola, con la sua innovazione ottica brevettata, costituisce il punto centrale del progetto e permette di gestire la luce nello spazio.

Materiali

Metacrilato, acciaio, alluminio.

Specificità

Si compone di un corpo ottico posto all'interno di un riflettore a parabola con una distanza minima tra i due elementi calcolata per evitare punti d'ombra. Lo snodo consente di direzionare il corpo ottico verso il riflettore o direttamente nell'ambiente.

Featuring an innovative patented optical unit, the parabola is the core of the project and allows to manage light in space.

Materials

Methacrylate, steel, aluminum.

Specification

It consists of an optical unit fitted inside a parabolic reflector with a minimum distance between both elements calculated in order to prevent any dark spots. The joint allows to direct the optical unit towards the reflector or straight into the environment.

La parabole, par son innovation optique brevetée, constitue le point central du projet et permet de gérer la lumière dans l'espace.

Matériaux

Méthacrylate, acier, aluminium.

Spécificité

Composée d'un corps optique placé à l'intérieur d'un réflecteur à parabole avec une distance minimale entre les deux éléments, calculée pour éviter des points d'ombre. L'articulation permet de diriger le corps optique vers le réflecteur ou directement dans l'espace.

Der Parabolspiegel mit seiner patentierten Lichtinnovation bildet den zentralen Punkt des Projekts und ermöglicht, das Licht im Raum zu steuern.

Materialien

Methacrylate, Stahl, Aluminium.

Spezifikation

Sie besteht aus einem Leuchtkörper innerhalb eines Parabolspiegels mit einem Mindestabstand zwischen den beiden berechneten Elementen, um Schattenbereiche zu vermeiden. Das Gelenk ermöglicht es, die optische Einheit zum Reflektor oder direkt in die Umgebung zu richten.

El reflector parabólico, con su innovación óptica patentada, constituye el punto central del proyecto y permite gestionar la luz en el espacio.

Materiales

Metacrilato, acero, aluminio.

Especificaciones

Está compuesto por un cuerpo óptico situado en el interior de un reflector parabólico con una distancia mínima entre los dos elementos calculada para evitar puntos de sombra. L'articulación permite de dirigir el cuerpo óptico hacia el reflector mismo o directamente en el ambiente.

Light emission



Colours



Diffuser:
Transparent



Lampada a soffitto disponibile come elemento singolo o in più unità componibili.

Materiali

Corpo lampada in alluminio con finitura verniciata; attacco a soffitto in acciaio; schermo diffusore in metacrilato diffondente.

Specificità

Un unico punto luce permette di alimentare, tramite una connessione elettrica, più elementi, garantendo un'ampia libertà di installazione.

Ceiling lamp available as a stand-alone element or as a configuration of multiple modular units.

Materials

Painted aluminium body; steel ceiling plate; methacrylate diffusing screen.

Specifications

A single power source is able to feed multiple elements via a mains connection, allowing a wide variety of installation options.

Plafonnier disponible en tant qu'élément unitaire ou en éléments pouvant être regroupés.

Matériaux

Corps en aluminium verni ; support mural en acier ; écran diffuseur en méthacrylate diffusant.

Spécificités

Un seul point de lumière qui permet d'alimenter par le biais d'une connexion électrique plusieurs éléments, garantissant ainsi une grande liberté d'installation.

Deckenleuchte erhältlich als einzelnes Element oder in mehreren modularen Einheiten.

Materialien

Körper aus lackiertem Aluminium; Deckenmontage aus Stahl; Schirm aus streuendem Methacrylat.

Spezifikation

Eine einzige Lichtquelle versorgt mehrere Elemente über eine elektrische Verbindung und bietet somit reichlich gestalterische Flexibilität.

Lámpara de techo disponible como un elemento independiente o en múltiples unidades modulares.

Materiales

El cuerpo compuesto de aluminio pintado; conexión de techo de acero; pantalla difusor de metacrilato.

Especificaciones

Un único punto de luz permite alimentar, gracias a una conexión eléctrica, más elementos, garantizado una amplia libertad de instalación.

Light emission



Colours



White



Orange

01

20-20

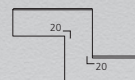

02

20-32

20-45



03

32-32

32-45

45-45





LED

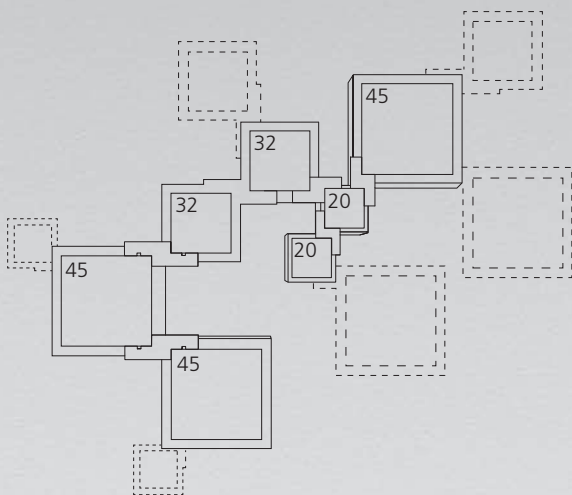

Float circolare ceiling

James Irvine
2000

Materiali

Struttura in alluminio verniciato; diffusore inferiore in metacrilato opalino; diffusore superiore in policarbonato trasparente.

Specificità

È possibile applicare un filtro blu o topazio all'emissione indiretta.

Materials

Structure in painted aluminium, lower diffuser in opaline methacrylate, upper diffuser in transparent polycarbonate.

Specification

A coloured filter, blue or topaz, may be fixed to the indirect light emission.

Matériaux

Structure en aluminium verni ; diffuseur inférieur en méthacrylate opalin ; diffuseur supérieur en polycarbonate transparent.

Spécificité

Un filtre coloré (bleu ou topaze) peut être ajouté, à l'émission indirecte.

Materialien

Struktur aus lackiertem Aluminium; unterer Schirm aus opalem Methacrylat; oberer Schirm aus transparentem Polycarbonat.

Spezifikation

Für die Versione Float circolare ist der Einsatz eines blauen oder goldgelben Farbfilters möglich.

Materiales

Estructura de aluminio pintado. Difusor inferior de metacrilato opalino, difusor superior en policarbonato transparente.

Especificaciones

Es posible aplicar un filtro azul o topacio para la emisión de luz indirecta.

Light emission



Colours



White





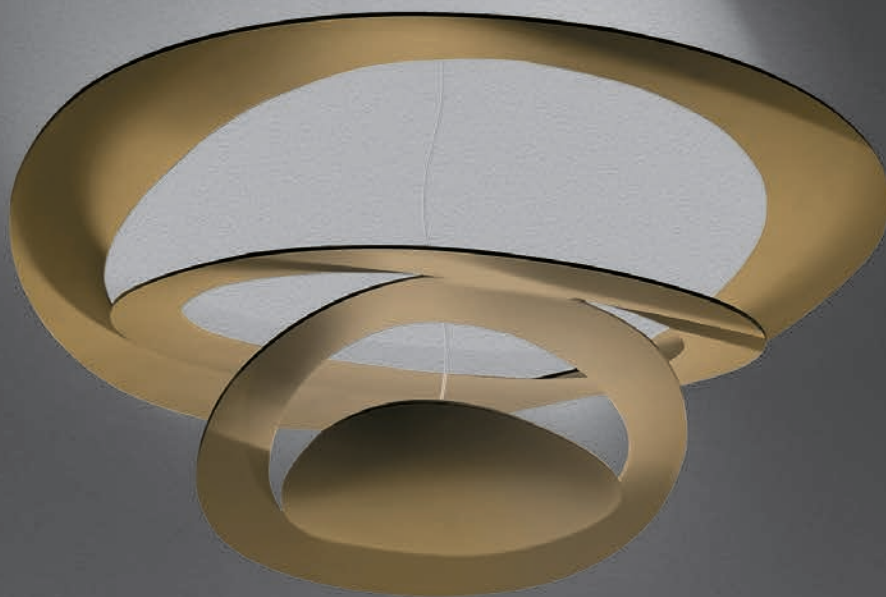

Materiali

Alluminio verniciato. Da un disco sottile si aprono volute fluttuanti, che ricadono morbidamente verso il basso, creando magici effetti di forma e luce.

Materials

Painted aluminium. From a thin ceiling plate, gently descending waving spirals create enchanting effects of form and light.

Matériaux

Aluminium verni. Un disque mince donne naissance à des volutes flottantes qui retombent doucement vers le bas en créant des effets magiques de formes et de lumière.

Materialien

Lackiertes Aluminium. Eine feine Scheibe geht in sanft geschwungene Spiralen über, die sich nach unten neigen und magische Lichteffekte erzeugen.

Materiales

Aluminio pintado. De un disco fino parten espirales fluctuantes que caen suavemente hacia abajo, creando mágicos efectos de forma y luz.



250 420

LED

LED

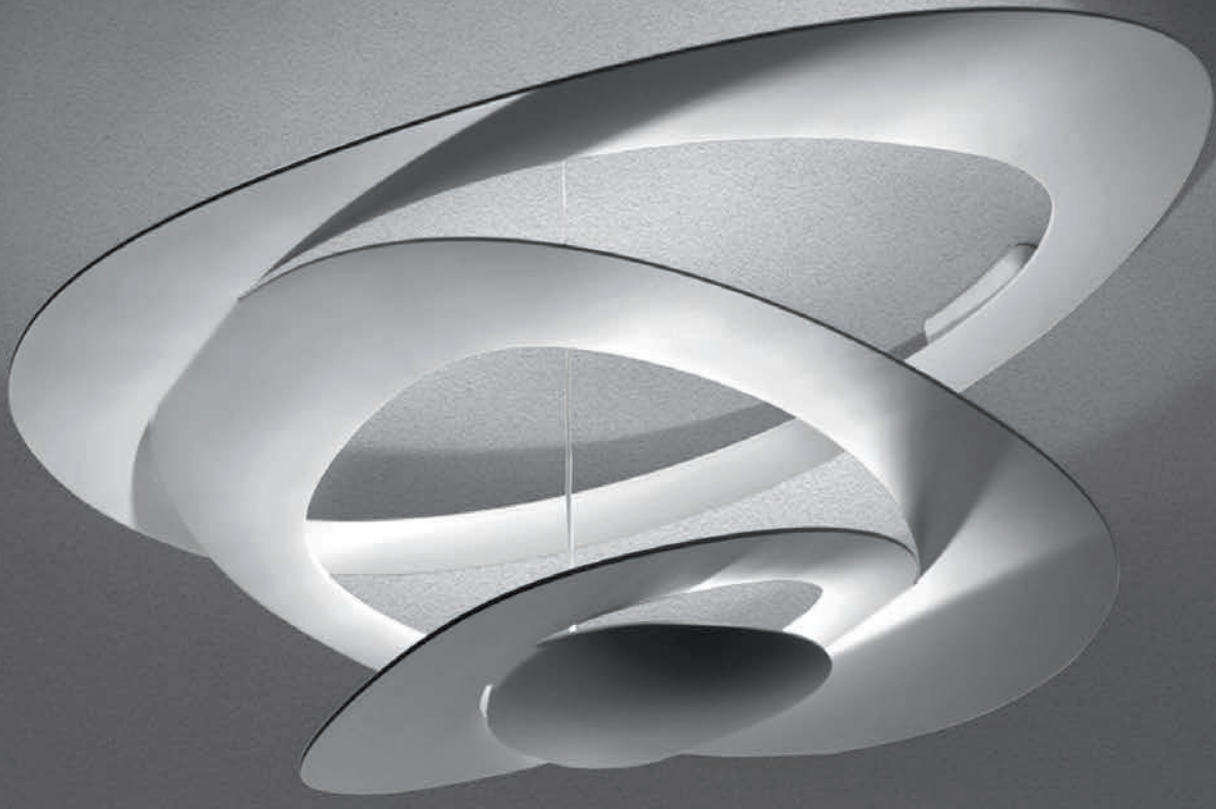

Light emission



Colours

- Polished white
- Gold (only LED)

Pirce ceiling white

Led Net line 66, 125

Michele De Lucchi
Alberto Nason
2011

Materiali

Struttura in alluminio verniciato. Ogni LED è dotato di lente in metacrilato trasparente e di porta-lente in metacrilato satinato.

Specificità

Grazie al ridotto cono di emissione (70°), Led Net line è anche adatto per uffici, dove è richiesto il controllo dell'abbagliamento.

Materials

Painted aluminium structure. Each LED is fitted with a transparent methacrylate lens and a satin finish methacrylate lens-holder.

Specification

Thanks to its reduced angular emission cone (70°), Led Net line is also suitable for offices, where glare control is needed.

Matériaux

Structure en aluminium peint. Chaque LED est munie d'une lentille en méthacrylate transparent et d'un porte-lentille en méthacrylate satiné.

Spécificité

Grâce au réduit cône d'émission (70°), Led Net line est également adapté pour les bureaux, où le contrôle d'éblouissement est nécessaire.

Materialien

Struktur aus lackiertem Aluminium. Alle LEDs mit Linse aus transparentem Methacrylat und Linsenträger aus mattem Methacrylat.

Spezifikation

Dank des kleinen Abstrahlwinkels (70°), ist Led Net line auch für Büros geeignet, in denen ein Blendschutz erforderlich ist.

Materiales

Estructura de aluminio pintado. Cada LED consta de lente de metacrilato transparente y de porta-lente de metacrilato satinado.

Especificaciones

Gracias al cono de emisión reducida (70°), Led Net line es también apto para oficinas, donde se requiere el control del deslumbramiento.



Light emission



Colours

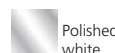



Led Net circle

Michele De Lucchi
Alberto Nason
2011

Materiali

Struttura in alluminio verniciato. Ogni LED è dotato di lente in metacrilato trasparente e di porta-lente in metacrilato satinato.

Specificità

Grazie al ridotto cono di emissione (70°), Led Net circle è anche adatto per uffici, dove è richiesto il controllo dell'abbagliamento.

Materials

Painted aluminium structure. Each LED is fitted with a transparent methacrylate lens and a satin finish methacrylate lens-holder.

Specification

Thanks to its reduced angular emission cone (70°), Led Net circle is also suitable for offices, where glare control is needed.

Matériaux

Structure en aluminium peint. Chaque LED est munie d'une lentille en méthacrylate transparent et d'un porte-lentille en méthacrylate satiné.

Spécificité

Grâce au réduit cône d'émission (70°), Led Net circle est également adapté pour les bureaux, où le contrôle d'éblouissement est nécessaire.

Materialien

Struktur aus lackiertem Aluminium. Alle LED mit Linse aus transparentem Metacrylat und Linsenträger aus mattem Metacrylat.

Spezifikation

Dank des kleinen Abstrahlwinkels (70°), ist Led Net circle auch für Büros geeignet, in denen ein Blendschutz erforderlich ist.

Materiales

Estructura de aluminio pintado. Cada LED consta de lente de metacrilato transparente y de porta-lente de metacrilato satinado.

Especificaciones

Gracias al cono de emisión reducida (70°), Led Net circle es también apto para oficinas, donde se requiere el control del deslumbramiento.

Light emission



Colours



Polished
white



Led Net circle

Invero ceiling Invero 214 ceiling

Carlotta de Bevilacqua
2015

Materiali

Struttura in alluminio, diffusore di vetro soffiato con tecnica "Zanfirico".

Specificità

Il diffusore in vetro soffiato è realizzato con la tecnica dello Zanfirico, variante della filigrana con fili intrecciati sviluppatasi nel Rinascimento.

Materials

Aluminium frame, glass diffuser blown with the "Zanfirico" technique.

Specification

The blown-glass diffuser is obtained with the Zanfirico technique, a variation of filigree, with intertwined threads, developed during the Renaissance age.

Materiaux

structure en aluminium, diffuseur en verre soufflé par la technique "Zanfirico".

Spécificité

Le diffuseur en verre soufflé est réalisé selon la technique Zanfirico, variante de la filigrane, avec des fils tressés, qui s'était répandue à la Renaissance.

Materialien

Aluminiumstruktur, Diffusor aus geblasenem Glas mit "Zanfirico"-Technik.

Spezifikation

Der Diffusor aus geblasenem Glas wird durch die "Zanfirico"-Technik hergestellt, eine Variante der Filigranarbeit mit verdrehten Fäden, die in der Renaissance entwickelt wurde.

Materiales

Estructura de aluminio, difusor de vidrio soplado con técnica "Zanfirico".

Especificaciones

El difusor de vidrio soplado está hecho con la técnica del Zanfirico, variante de la filigrana con hilos entrelazados desarrollada durante el Renacimiento.

Light emission



Colours



Structure:
Mirror



Structure:
White



Diffuser:
White Zanfirico



Diffuser:
Blue Zanfirico





LED

336



Incalmo ceiling Incalmo 214 ceiling

Carlotta de Bevilacqua
2015

Materiali

Struttura in alluminio, diffusore in vetro soffiato con tecnica a Incalmo.

Specificità

Incalmo cita una tecnica ideata a Murano nel XVI secolo grazie alla quale è possibile ottenere vetri soffiati caratterizzati da due o più zone di colore diverso. L'alternanza di bande orizzontali trasparenti e di colore bianco o grigio ne trasforma il corpo decorativo in un elemento di controllo e diffusione dell'emissione luminosa. Disponibile in due grandezze.

Materials

Aluminium frame, blown-glass diffuser based on the "incalmo" technique.

Specification

Incalmo refers to a technique introduced in the 16th century in Murano, which allows to obtain blown glass with two or more parts of different colours. The alternating clear and white or grey horizontal bands transform the ornamental body into a control unit for lighting emission. Available in two sizes.

Matériaux

Structure en aluminium, diffuseur en verre soufflé, technique 'Incalmo'.

Spécificité

Incalmo cite une technique conçue à Murano au XVI^e siècle grâce à laquelle on peut obtenir des verres soufflés caractérisés par deux ou plusieurs zones d'une couleur différente. L'alternance de bandes horizontales transparentes et de couleur blanche ou grise transforme le corps décoratif en un élément de contrôle et diffusion de l'émission lumineuse. Disponible en deux dimensions.

Materialien

Aluminiumstruktur, Diffusor aus geblasenem Glas mit Incalmo-Technik.

Spezifikation

Incalmo zitiert eine Technik, die im sechzehnten Jahrhundert in Murano entwickelt wurde, um geblasenes Glas in zwei oder mehr Farben zu erhalten. Der Wechsel von transparenten Querstreifen und der Farbe Weiß oder Grau verwandelt den dekorativen Leuchtenkörper in ein Steuerelement zur Verteilung des Lichts. In zwei Größen erhältlich.

Materiales

Estructura de aluminio, difusor de vidrio soplado con técnica de Incalmo.

Especificaciones

Incalmo menciona una técnica ideada en Murano en el siglo XVI con la que es posible obtener vidrios soplados caracterizados por dos o más zonas de color diferente. La alternancia de franjas horizontales transparentes y de color blanco o gris convierte el cuerpo decorativo en un elemento de control y difusión de la emisión luminosa. Disponible en dos tamaños.

Light emission



Colours



Structure:
Mirror



Structure:
White



Diffuser:
White Incalmo



Diffuser:
Grey Incalmo



LED

332



Logico ceiling
Logico mini ceiling
Logico micro ceiling

Michele De Lucchi
Gerhard Reichert
2001



Materiali

Struttura in metallo verniciato; diffusore in vetro soffiato con finitura seta lucida. Soffiatura a tre strati (cristallo + effetto seta + cristallo) in stampo a fermo con forma capovolta per garantire solidità strutturale del vetro.

Specificità

La forma modulare si presta alla componibilità e alla realizzazione di combinazioni personalizzate, fornite come progetto speciale.

Materials

Painted metal structure, blown glass diffuser with a polished-silk finish. Three layers of glass (crystal + silk + crystal) are blown in an upside down mould to ensure structural consistence to glass.

Specification

Its modular shape lends itself to the creation and realisation of customized compositions, supplied as custom project.

Matériaux

Structure en métal verni ; diffuseur en verre soufflé, finition soie brillante. Verre soufflé en trois couches (cristal + effet soyeux + cristal) dans un moule qui a une forme inversée pour garantir la solidité structurale du verre.

Spécificité

Sa forme modulaire permet de personnaliser les compositions; produit spécial à définir pour tout projet.

Materialien

Rahmen aus lackiertem Metall; Schirm aus geblasenem Glas in seidig glänzendem Finish. Drei Glasschichten (Kristall + Seide + Kristall) die umgekehrt positioniert sind um die Stabilität des Glases zu gewährleisten.

Spezifikation

Die Leuchtenmodule erlauben eine individuell gestaltete Anordnung, die als kundenspezifische Lichtlösung erhältlich sind.



Materiales

Estructura de metal pintado; difusor de cristal soplado con acabado de seda brillante. Soplado a tres capas (cristal + efecto seda + cristal) en un molde con forma invertida para asegurar la resistencia estructural del cristal.

Especificaciones

Su forma modular, se presta para realizar combinaciones personalizadas, suministrado como proyecto especial.

Awards

2002 – Design Innovationen
 Design Zentrum Nordrhein Westfalen
 2002 - Reddot Design Award
 Essen (Deutschland)

Only for custom projects – which feasibility must be approved by Artemide technical design department – it's possible to create different combinations by joining the elements Logico.

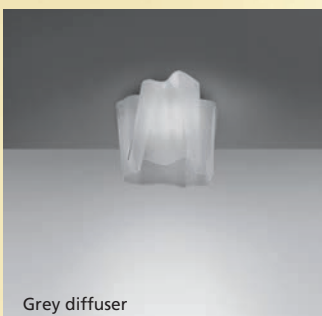

Grey diffuser

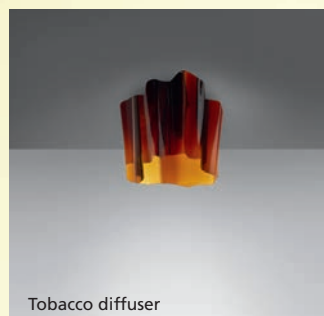

Tobacco diffuser

Light emission



Colours

-  Structure Silver Grey
-  Diffuser White
-  Diffuser: Tobacco
-  Diffuser: Grey

Logico ceiling 3x120°



Materiali

Corpo lampada in alluminio; diffusore in policarbonato.

Specificità

All'emissione diretta si aggiunge un'emissione indiretta che produce un alone di luce decorativo sul soffitto.

Materials

Aluminium body lamp; polycarbonate diffuser.

Specification

In addition to the direct emission, an indirect emission creates a halo of decorative light on the ceiling.

Matériaux

Corps en aluminium ; diffuseur en polycarbonate.

Spécificité

L'émission directe s'enrichit d'une émission indirecte qui produit un halo lumineux décoratif au plafond.

Materialien

Leuchtenkörper aus Aluminium; Schirm aus Polycarbonat.

Spezifikation

Der direkte Lichtaustritt wird durch indirektes Licht ergänzt, das an der Zimmerdecke einen dekorativen Lichtkranz entstehen lässt.

Materiales

Cuerpo de la lámpara en aluminio; difusor en policarbonato.

Especificaciones

A la emisión de luz directa se suma la indirecta, para dar vida a un halo de luz decorativo sobre el techo.



288

LED

LED



Light emission



Colours



Anodized



Anthracite grey

Nur mini ceiling anthracite grey



Materiali

Corpo lampada in alluminio verniciato; diffusore in policarbonato.

Specificità

Una finitura perfettamente liscia e lucida conferisce eleganza al classico modello Nur. All'emissione diretta si aggiunge un'emissione indiretta che produce un alone di luce decorativo sul soffitto.

Materials

Painted aluminium body lamp; polycarbonate diffuser.

Specification

A perfectly smooth and polished finish adding that extra touch of elegance to the classic Nur model. In addition to the direct emission, an indirect emission creates a halo of decorative light on the ceiling.

Matériaux

Corps en aluminium verni; diffuseur en polycarbonate.

Spécificité

Une finition parfaitement lisse et brillante donne plus d'élégance au modèle Nur classique. L'émission directe s'enrichit d'une émission indirecte qui produit un halo lumineux décoratif au plafond.

Materialien

Körper aus lackiertem Aluminium; Schirm aus Polycarbonat.

Spezifikation

Die Hochglanzpolitur verleiht dem Klassiker Nur eine besondere Eleganz. Der direkte Lichtaustritt wird durch indirektes Licht ergänzt, das an der Zimmerdecke einen dekorativen Lichtkranz entstehen lässt.



294

LED

LED



Materiales

Cuerpo de aluminio pintado; difusor en policarbonato.

Especificaciones

Un acabado perfectamente liso y brillante confiere elegancia al clásico modelo Nur. A la emisión de luz directa se suma la indirecta, para dar vida a un halo de luz decorativo sobre el techo.

Light emission



Colours



Polished black



Polished white

Materiali

Corpi riflettenti in ABS stampato ad iniezione; corpo illuminante in pressofusione di alluminio; struttura portante in acciaio verniciato.

Specificità

Skydro è disponibile con o senza corpo illuminante integrato e nelle versioni con sorgente alogena e LED. Grazie alla componibilità del sistema, aggregando più unità di uno stesso modulo si possono ottenere un numero elevatissimo di configurazioni. Per il montaggio di configurazioni multiple, è necessario, oltre al modulo base (con o senza sorgente luminosa), un kit di montaggio (dima) ed i kit cavi per il collegamento elettrico.

Materials

ABS injection-moulded reflective units; lighting unit in die cast aluminium; painted steel load-bearing structure.

Specification

Skydro is available with or without integrated lighting unit; in halogen or LED. Thanks to the modularity of the system, several configurations can be created simply adding additional units. To assemble additional units, in addition to the basic modules (with or without light source) an assembly kit (template) and cable kits for the electrical connection are required.

Matériaux

Unités réfléchissantes en ABS moulé, unité d'éclairage en fonte d'aluminium, structure porteuse en acier peint.

Spécificité

Skydro est disponible avec ou sans source lumineuse, en version halogènes ou LED. Compte tenu de la modularité du système, il est possible d'obtenir de nombreuses configurations, en ajoutant simplement des éléments. Pour l'installation d'unités multiples, un kit d'assemblage est nécessaire (gabarit), des kits de câblage pour la connexion électrique, ainsi que des unités de base (avec ou sans source lumineuse).

Materialien

Reflektierende Körper aus Spritzgussthermoplast; Reflektor aus formgestanztem Aluminium; Struktur aus lackiertem Stahl.

Spezifikation

Skydro ist mit integriertem oder externem Strahler erhältlich. Wahlweise mit Halogen-oder LED. Die modulare Struktur ermöglicht die Kombination mehrerer Skydro-Elemente. Hierdurch entstehen beliebig große Konfigurationen. Zur Verkabelung mehrerer Einheiten ist ein elektronischer Verbinder sowie ein Montage-Kit erforderlich.

Materialies

Cuerpo reflexivo en ABS estampado a inyección, cuerpo luminoso en presofusión de aluminio, estructura portante en acero pintado.

Especificaciones

Skydro está disponible en dos versiones: con o sin cuerpo luminoso integrado. Gracias a la composición del sistema, agregando los módulos se pueden obtener numerosas configuraciones. Para el montaje de configuraciones múltiples son necesarios- más allá de los módulos base (con o sin fuente de luz- un kit de montaje - dima - y un kit de cables para la conexión eléctrica).



Light emission



Colours



Mirror

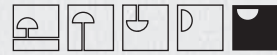

LED

LED

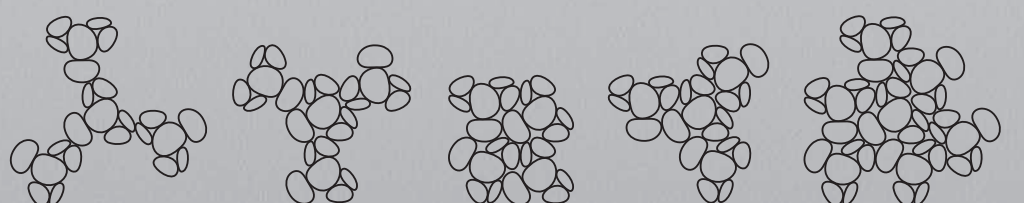
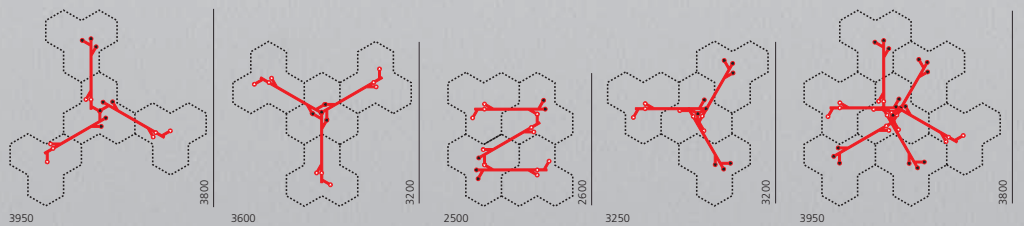



Materiali

Corpi luminosi in alluminio pressofuso; riflettore in alluminio stampato e verniciato.

Materials

Die-cast aluminium lighting units; painted die-cast aluminium reflector.

Matériaux

Corps lumineux en aluminium moulé sous pression. Réflecteur en aluminium moulé et verni.

Materialien

Leuchtenkörper aus druckgegossenem Aluminium; Reflektor aus formgestanztem Aluminium.

Materiales

Cuerpos luminosos en aluminio fundido a presión; reflector en aluminio moldeado y pintado.



474

LED

LED

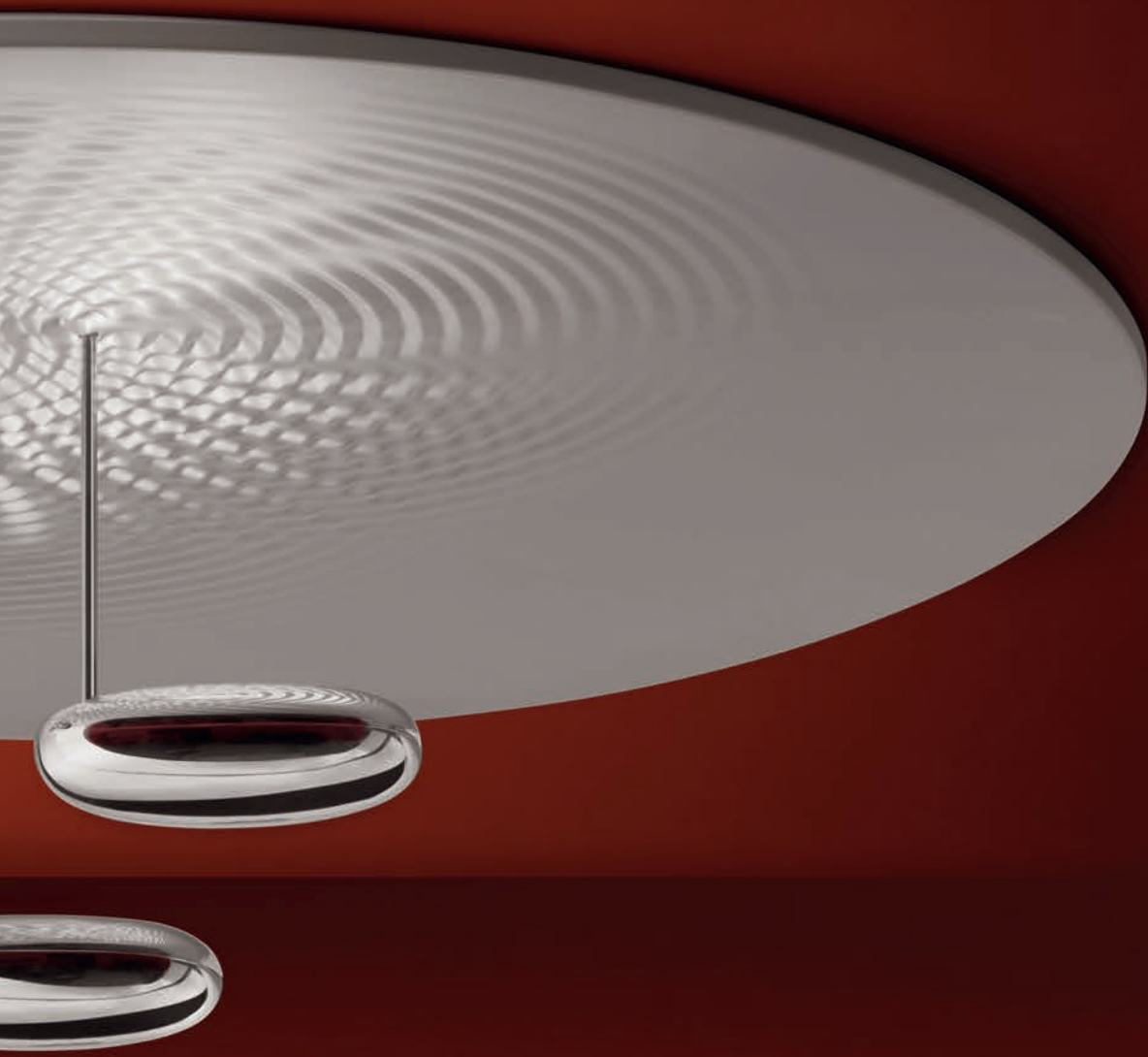

Light emission



Colours

Reflector:
Aluminium grey

Units:
Mirror

Materiali

Corpo lampada-riflettore in materiale termoplastico;
diffusore posteriore in metacrilato opalino.

Materials

Body lamp-reflector made of thermoplastic material;
back diffuser in opal methacrylate.

Matériaux

Corps réflecteur en matériau thermoplastique; diffuseur
arrière en méthacrylate opalin.

Materialien

Leuchtenkopf aus thermoplastischem Material; hinterer
Schirm aus opalem Methacrylat.

Materialies

Cuerpo lámpara-reflector en material termoplástico.
Difusor posterior en metacrilato opal.

Light emission



Colour



Mirror

Awards

2010 – Design Innovationen Design Zentrum
Nordrhein Westfalen
Reddot Design Award – Product Design
Essen (Deutschland)

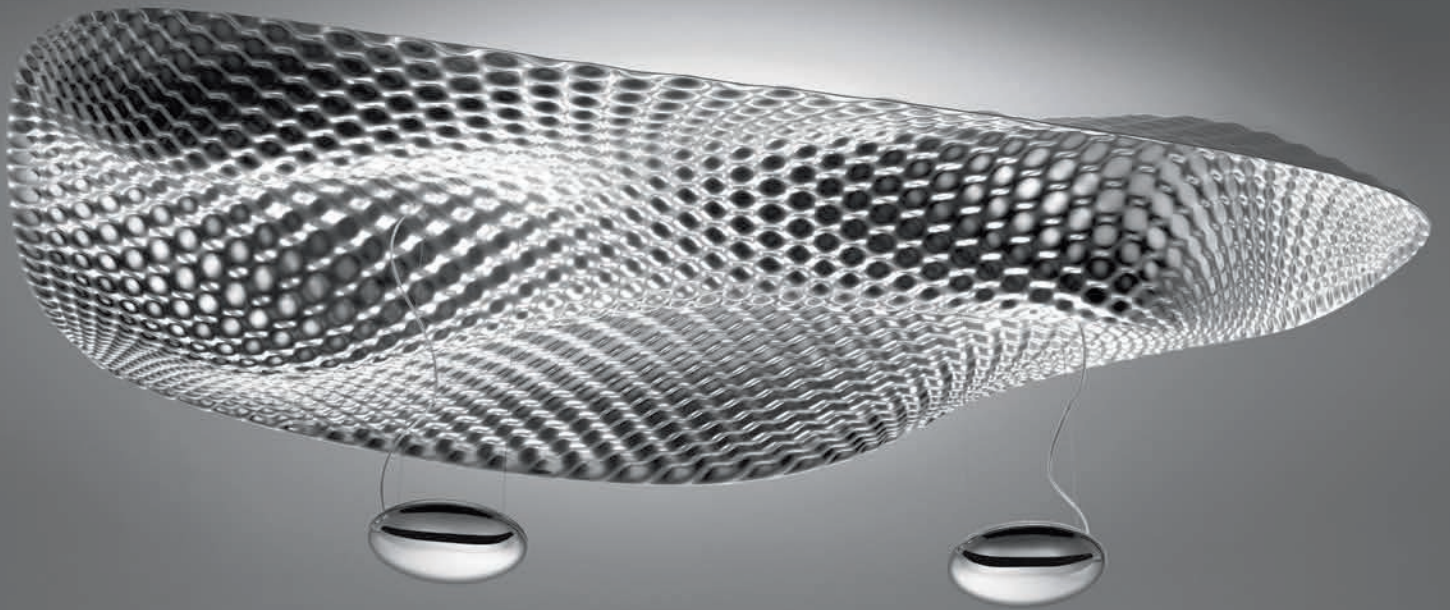

Mercury ceiling Mercury mini ceiling

Ross Lovegrove
2007

Materiali

Corpi luminosi in alluminio pressofuso; corpi riflettenti in materiale termoplastico stampato ad iniezione con finitura metallizzata; riflettore in acciaio inox.

Materials

Die-cast aluminium lighting units; reflective units made of injection-moulded thermoplastic material with metallic finish; stainless steel reflector.

Matériaux

Corps en aluminium moulé sous pression; galets réfléchissants en matériau thermoplastique finition métallisée ; réflecteur en acier inoxydable.

Materialien

Leuchtenkörper aus druckgegossenem Aluminium; reflektierende Körper aus Spritzguss-Thermoplast mit Metallic-Oberfläche, Reflektor aus Edelstahl.

Materiales

Cuerpos luminosos en aluminio fundido a presión; cuerpos reflectantes en material termoplástico moldeado por inyección, con acabado metalizado; reflector en acero inoxidable.

Light emission



Colours



Awards

Mercury ceiling
2008 – Good Design Award
The Chicago Atheneum, Chicago (US)



296

LED

LED



Mercury mini ceiling



“Botanic rain usa un sofisticato polimero cristallino per rifrangere e riflettere la luce attraverso un modulo a forma di foglia ispirato alla botanica che è lasciato sospeso, in modo da creare un sistema polimerico a facciata continua”.

Materiali

Profilo illuminante in alluminio. Elementi a cascata in materiale termoplastico stampato a iniezione. Il profilo è disponibile a incasso o a soffitto e in diverse lunghezze.

“Botanic rain is made of an advanced crystal polymer able to refract and reflect light. Its suspended leaf modules, inspired by botanic shapes, create a polymer curtain wall system”.

Materials

Aluminium lighting profile. Suspended elements made of injection-moulded thermoplastic material. The profile is available recessed or ceiling-mounted and with different lengths.

« Botanic rain utilise un polymère cristallin sophistiqué pour réfracter et réfléchir la lumière à travers un module en forme de feuille, emprunté à la botanique et restant suspendu, de manière à créer un système polymérique à facettes continues ».

Matériaux

Profilé éclairant en aluminium. Eléments à cascade en matériau thermoplastique moulée par injection. Le profilé est disponible en version encastrable et en différentes longueurs.

„ Abgependelte Module, deren blattförmiges Design von der Botanik inspiriert wurde, bilden einen attraktiven Vorhang aus Kristallpolymeren, die das Licht brechen und reflektieren..“

Materialien

Leuchtprofil aus Aluminium. Kaskadenelemente aus spritzgegossem thermoplastischem Material. Das Profil ist als Einbau- oder Deckenversion in verschiedenen Längen lieferbar.

“Botanic rain emplea un polímero cristallino para refractar y reflejar la luz a través de un módulo con forma de hoja, de inspiración vegetal. Al colgarlo, se crea un sistema polimérico que da vida a una fachada cortina”.

Materiales

Perfil luminoso de aluminio; elementos en cascada de material termoplástico moldeado por inyección. El perfil está disponible para empotrar o como plafón y viene en varios largos diferentes.

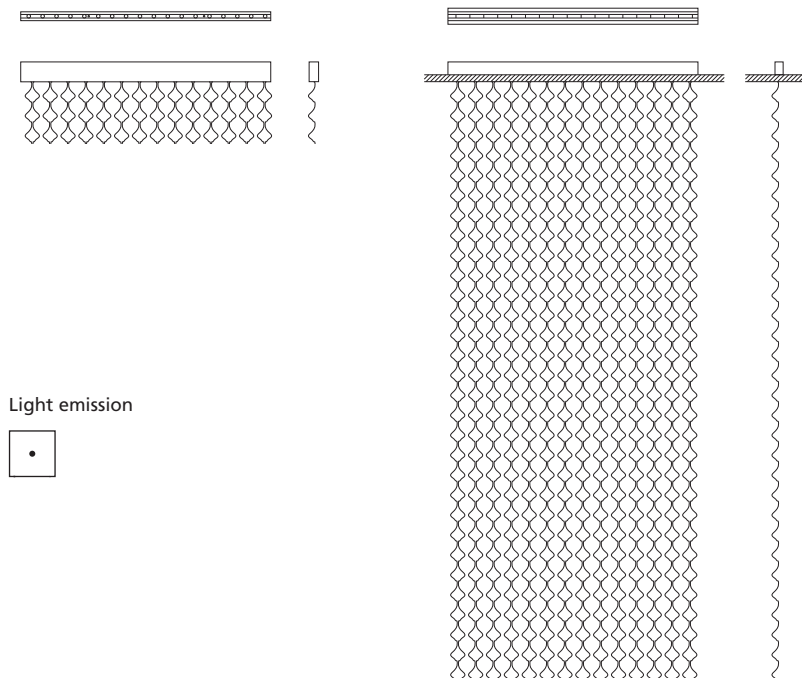

Only for custom projects which feasibility must be approved by Artemide technical design department

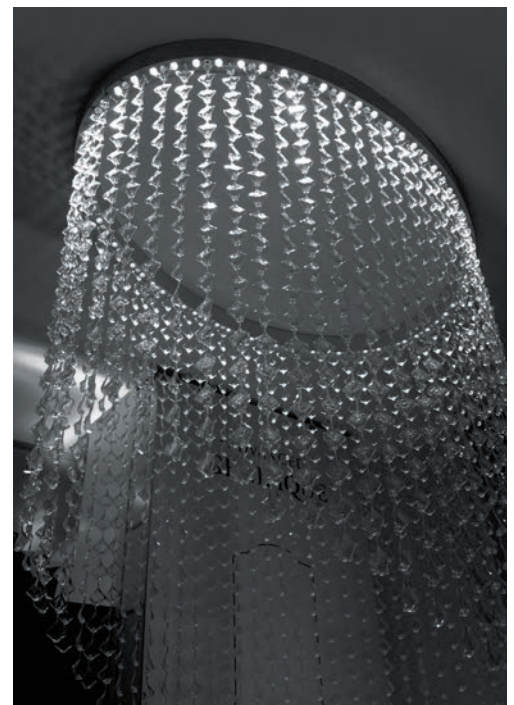

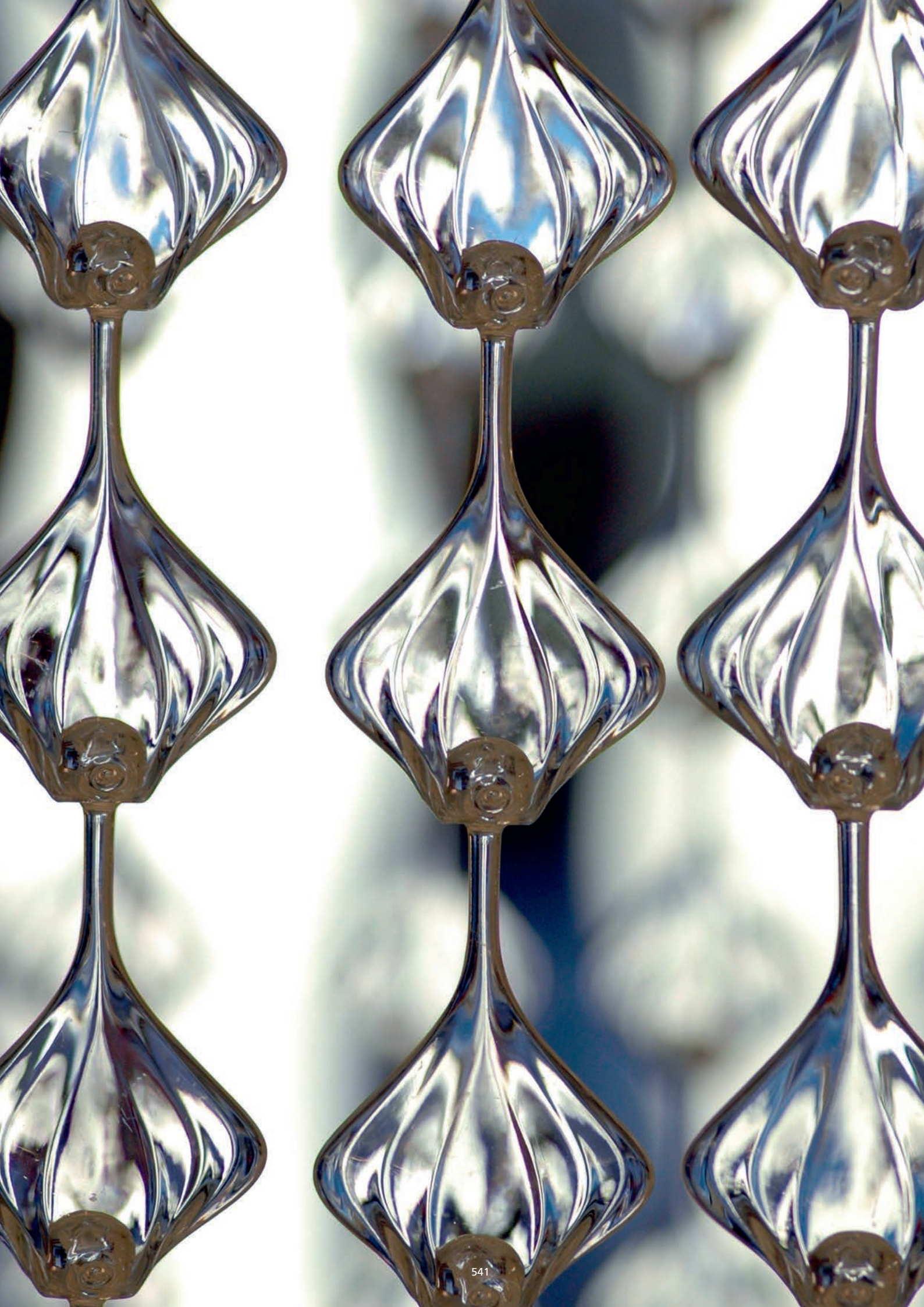

Masters' Pieces



544
Alfa



546
Eclisse



548
Lesbo



550
Nesso
Nessino



566
Dulcinea



568
Montjuic



570
Pipe LED



574
Aggregato
Aggregato
saliscendi



552
Fato



554
Patrolo



556
Boalum



558
Callimaco LED



560
Pausania



562
Shogun



564
Chimera



564
Mezzachimera



576
Noto



578
Pantalica
Pantalica wall



580
Hsiang



582
Prometeo LED



584
Yang



588
Metacolor LED

Materiali

Struttura in acciaio nichelato opaco; diffusore in cristallo;
base in marmo. Parti metalliche tornite a mano.

Materials

Steel structure in opaque nickel-plate; diffuser in crystal glass;
base in marble. The metal parts are hand turned.

Matériaux

Structure en acier nickelé mat ; diffuseur en verre ;
base en marbre. Les parties métalliques sont tournées
à la main.

Materialien

Rahmen aus matt vernickeltem Stahl; Leuchtschirm aus
Kristall. Sockel aus Marmor. Die Metallteile sind handgedreht.

Materialies

Estructura de acero niquelado mate; difusor de cristal;
base de mármol. Las piezas metálicas están torneadas
a mano.

Light emission**Colours**

Base:
Black



Structure:
Mirror



Diffuser:
White



LED



Eclisse

Vico Magistretti
1967

Materiali

Acciaio verniciato.

Specificità

Installabile anche a parete.

Materials

Painted steel.

Specificity

Can also be wall-mounted.

Matériaux

Acier verni.

Spécificité

Fixation possible en applique.

Materialien

Lackiertes Stahl.

Spezifikation

Wandmontage möglich.

Materiales

Acero pintado.

Especificaciones

Posibilidad de instalación a pared.

Awards

1967 – Compasso d'Oro/ADI
XIV Triennale di Milano
Milano (Italia)

Museums

Twentieth Century Design Collection
of the Metropolitan Museum of Art
New York (US)
Design Collection of the Museum
of Modern Art – New York (US)
Itinerario Storico Permanente
Museo Nazionale della Scienza
e della Tecnica L. da Vinci
Milano (Italia)
Sezione Design
Civica Galleria d'Arte Moderna
Gallarate (Italia)
The Denver Art Museum
Denver (Colorado, US)
The Israel Museum – Jerusalem (Israel)
Musée des Arts Décoratifs
de Montréal – Montréal (Canada)
Museo Permanente del Design Italiano
1945/1990 – Triennale di Milano
Milano (Italia)
Galleria Nazionale d'Arte Moderna
Roma (Italia)



Light emission



Colours



Polished white



Polished orange



Polished red



LED



Lesbo

Angelo Mangiarotti
1967

Materiali

Corpo e diffusore in vetro Murano soffiato-sfumato,
base in alluminio lucidato.

Materials

Body and diffuser in blown frosted Murano glass;
base in polished aluminium.

Matériaux

Corps et diffuseur en verre de Murano soufflé ;
base en aluminium poli.

Materialien

Körper und Leuchtschirm aus opalweißem,
mundgeblasenem Muranoglas; Sockel aus poliertem Aluminium.

Materiales

Cuerpo y difusor de cristal de Murano ahumado-soplado,
base de aluminio pulido.



Light emission



Colours





LED



Nesso Nessino

Giancarlo Mattioli
Gruppo architetti urbanisti città nuova
1967

Materiali

Nesso: base e diffusore in resina ABS stampata ad iniezione.
Nessino: base e diffusore in policarbonato stampato a iniezione.

Materials

Nesso: base and diffuser in ABS resin injected.
Nessino: Injection-moulded polycarbonate base and diffuser.

Matériaux

Nesso : base et diffuseur en injection de résine ABS.
Nessino : corp et diffuseur en polycarbonate moulé.

Materialien

Nesso: Sockel und Leuchtschirm ABS-Kunstharz,
das im Spritzgussverfahren.
Nessino: Körper und Schirm aus Polycarbonat ist spritzgegossen.

Materialies

Nesso: base y difusor de resina ABS, moldeados
por inyección.
Nessino: cuerpo y difusor en policarbonato estampado
a inyección.

Awards

1965 – 1° Premio Concorso
Studio Artemide/Domus
Milano (Italia)

Museums

Twentieth Century Design Collection
of the Metropolitan Museum of Art
New York (US)
Design Collection of the Museum
of Modern Art – New York (US)
The Denver Art Museum
Denver (Colorado, US)
The Israel Museum – Jerusalem (Israel)
Musée des Arts Décoratifs de Montréal
Montréal (Canada)
Museo Permanente del Design Italiano
1945-1990 – Triennale di Milano
Milano (Italia)



Light emission



Colour

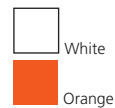



LED



Fato

Gio Ponti

1969

Materiali

Struttura in lamiera piegata, saldata e smaltata.

Specificità

Questa lampada, con i suoi schermi metallici geometrici, le sue campiture di luce ed ombra, di vuoti e pieni, racchiusi in una cornice quadrata, si presenta come un oggetto luminoso dalla duplice funzione: lampada e insieme vetrina.

Una scultura luminosa con una forte connotazione stilistica tipica degli anni 60.

Materials

Structure in enamelled, folded and welded plate.

Specificity

A table or wall lamp, with geometrical metal screens creating light and dark, screen and void, all enclosed in a square frame: it is both a light and a display piece. A lighting sculpture with a strong '60s design influence.

Matériaux

Structure en tôle émaillée, pliée et soudée.

Spécificité

Avec ses écrans métalliques géométriques, ses peintures de fond de lumière et d'ombre, de pleins et de vides, renfermés dans un cadre carré, cette lampe de table ou applique se présente tel un objet lumineux multifonctions : lampe et vitrine évoquant une sculpture lumineuse dans les style typique des années 60.

Materialien

Rahmen aus gekrümmtem, geschweißtem und lackiertem Metall.

Spezifikation

Die geometrischen Flächen in dem quadratischen Metallrahmen erzeugen ein attraktives Licht- und Schattenspiel. Fato ist Leuchte und Objekt zugleich. Ob Vitrine oder Tisch- oder Wandleuchte, Fato ist eine Lichtskulptur im typischen Stil der 60er Jahre.

Eine Lichtskulptur mit einer starken stilistischen, Konnotation der 60er Jahre.

Materiales

Estructura de chapa esmaltada doblada y soldada.

Especificaciones

Esta lámpara de sobremesa o de pared con sus pantallas metálicas geométricas, sus juegos de luz y sombras, vacío y llenos, encerrado en un marco cuadrado, se presenta como un objeto luminoso multiuso: lámpara y vitrina. Una escultura luminosa con una fuerte connotación estilística típica de los años 60.



Light emission



Colours

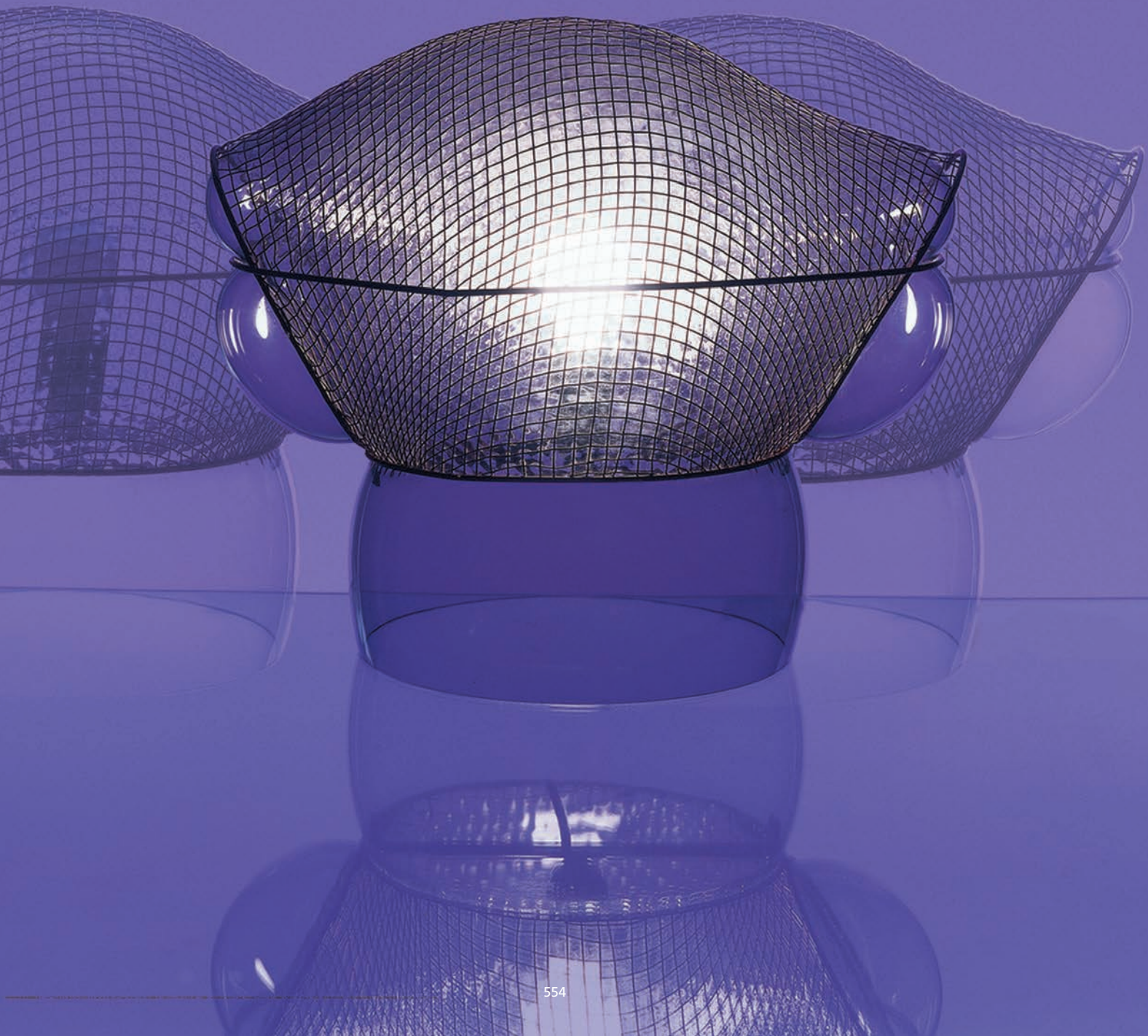

Photo by Aldo Ballo, 1969



LED







LED

Materiali

Corpo in vetro soffiato trasparente con parte del diffusore rivestita da un'armatura metallica romboidale irregolare. L'armatura è ottenuta con la saldatura di fili d'acciaio resistenti al calore del vetro che viene soffiato a mano nella gabbia.

Specificità

Il vetro così sfaccettato produce una texture luminosa sulle pareti.

Materials

Body in transparent blown glass with the diffuser partially covered by an irregular rhomboid metal frame. The frame is made by welding steel wire, resistant to the heat of the glass which is hand-blown inside the cage.

Specificity

The faceted glass creates light patterns on the wall.

Matériaux

Corps en verre soufflé transparent avec un diffuseur revêtu d'une armature métallique rhomboïdale irrégulière. L'armature est réalisée grâce au soudage de fils d'acier résistant à la chaleur du verre qui est soufflé dans la cage.

Spécificité

Ainsi taillé en facettes, le verre éclaire la pièce avec des effets tachetés.

Materialien

Gehäuse aus transparentem, geblasenem Glas, das mit einem unregelmäßigen, rhomboiden Metallnetz verkleidet ist.

Spezifikation

Das Glas wird durch das Netz mundgeblasen und verschmilzt.

Materiales

Cuerpo de cristal soplado transparente con la parte de difusor forrada de un armazón metálico en forma de rombo irregular. El armazón se consigue soldando hilos de acero resistentes al calor del cristal, que se sopla en la caja.

Especificaciones

El cristal tallado de esta manera ilumina la habitación con signos diferentes.

Light emission



Colours



Transparent

Museums

Twentieth Century Design Collection
of the Metropolitan Museum of Art
New York (US)

The Denver Art Museum
Denver (Colorado, US)

Boalum

Livio Castiglioni
Gianfranco Frattini
1970





Materiali

Struttura in plastica bianca flessibile rinforzata e terminali in resina.

Specificità

Le piccole lampadine a siluro sono collegate in serie l'una all'altra e distanziate da una sfera isolante. I diversi elementi sono collegabili in serie fino ad un massimo di 4 pezzi per uno sviluppo di 8 metri circa e arrotolabili a piacere.

Materials

Structure in reinforced flexible white plastic with ends in resin.

Specificity

The small torpedo lamps are connected to each other in series and separated by an insulating sphere. Up to 4 individual sections may be connected to each other in series to make a length of 8 metres which may be wound into any shape.

Matériaux

Structure en plastique blanc flexible renforcée et extrémités en résine.

Spécificité

Les petites ampoules à silure sont raccordées en série les unes aux autres et séparées par une boule isolante. Les différents éléments flexibles sur toute leur longueur peuvent se raccorder pour composer un ensemble de 4 pièces d'environ 8 mètres. Emission lumineuse diffuse.

Materialien

Rahmen aus weißem, flexiblem Kunststoff und Endstücke aus Kunstharz.

Spezifikation

Die hinter einander liegenden kleinen Torpedolampen sind mit einander verbunden, zwischen ihnen liegt je eine isolierende Kugel. Maximal 4 Leuchten mit einer Gesamtlänge von 8m lassen sich zusammenstecken. Boalum kann beliebig zusammengerollt werden. Diffuse Lichtverteilung.

Materiales

Estructura de plástico blanco flexible reforzado y terminales de resina.

Especificaciones

Las pequeñas bombillas en forma de siluro están unidas en serie la una con la otra y distanciadas por una esfera aislante. Los elementos se pueden unir en serie hasta un máximo de 4 piezas, con un desarrollo de unos 8 metros, pudiéndolos enrollar a su gusto.

Light emission



Colours



White

Awards

1975 – BIO 5 – Honour Nomination
Ljubljana (Slovenia)

Museums

Musée des Arts Décoratifs de Montréal
Montréal (Canada)
1945-1990 – Museo Permanente
del Design Italiano
Triennale di Milano Milano (Italia)

Callimaco LED

Ettore Sottsass
1982

Materiali

Base e diffusore in acciaio verniciato; stelo in alluminio verniciato; maniglia in metallo cromato lucido.

Materials

Base and diffuser in painted steel; stem in painted aluminium; handle in polished chrome metal plate.

Matériaux

Base et diffuseur en acier verni ; tige en aluminium verni ; poignée en métal chromé.

Materialien

Sockel und Schirm aus lackiertem Stahl; Säule aus lackiertem Aluminium; Griff aus poliertem, verchromtem Metall.

Materiales

Pie y difusor de acero pintado; vástago de aluminio pintado y empuñadura, de metal cromado lúcido.

Awards

Twentieth Century Design Collection
of the Metropolitan Museum of Art
New York (US)

The Israel Museum
Jerusalem (Israel)



Light emission



Colours



Base:
Polished grey



Stem:
Polished yellow



Diffuser:
Polished red



LED



Pausania LED

Ettore Sottsass

1983

Riedizione della celebre lampada ministeriale di Ettore Sottsass, aggiornata in versione LED TW a luce bianca variabile.

Materiali

Corpo in resina nera, diffusore in metacrilato verde.

Re-edition of the famous lamp designed by Ettore Sottsass, updated in version LED TW at variable white light.

Materials

Body in black resin, diffuser in green synthetic material.

Il s'agit d'une réédition de la célèbre lampe ministérielle d'Ettore Sottsass, adaptée en version LED TW.

Matériaux

Corps en résine noire, diffuseur en méthacrylate vert.

Neuaufgabe der bekannten Leuchte von Ettore Sottsass als LED TW-Version, die Weißlicht in verschiedenen Lichtstärken und Farbtemperaturen abgibt.

Materialien

Körper aus schwarzem Kunstharz, Schirm aus grünem Methacrylat.

Reedición de la célebre lámpara de Ettore Sottsass, actualizada en versión LED TW con luz blanca variable.

Materiales

Cuerpo en resina negra, difusor en metacrilato verde.



Ph. Aldo Ballo, 1983

Light emission



Colours



Green/Aluminium

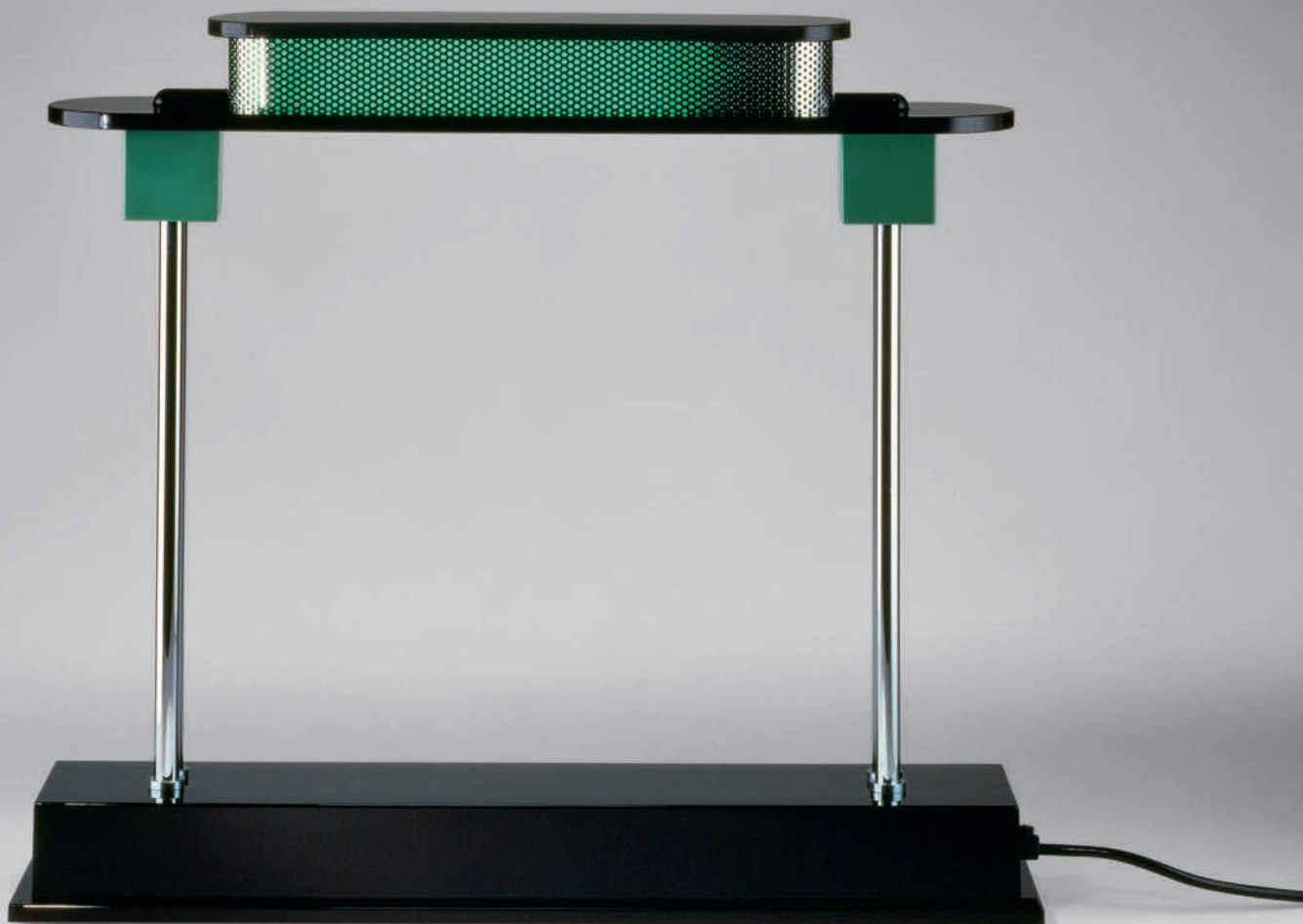

Shogun

Mario Botta
1986

Materiali

Stelo in metallo verniciato; diffusori orientabili in lamiera d'acciaio forata verniciata.

Materials

Painted metal stem; white adjustable diffusers in painted perforated plate steel.

Matériaux

Structure en métal verni ; diffuseurs orientables en tôle d'acier perforé verni.

Materialien

Säule aus lackiertem Metall, verstellbare Schirme aus gelochtem Stahlblech.

Materiales

Vástago de metal pintado; difusores pintados orientables, de chapa de acero perforada.

Awards

Twentieth Century Design Collection of the Metropolitan Museum of Art New York (USA)



Light emission



Colours



Black/White



LED

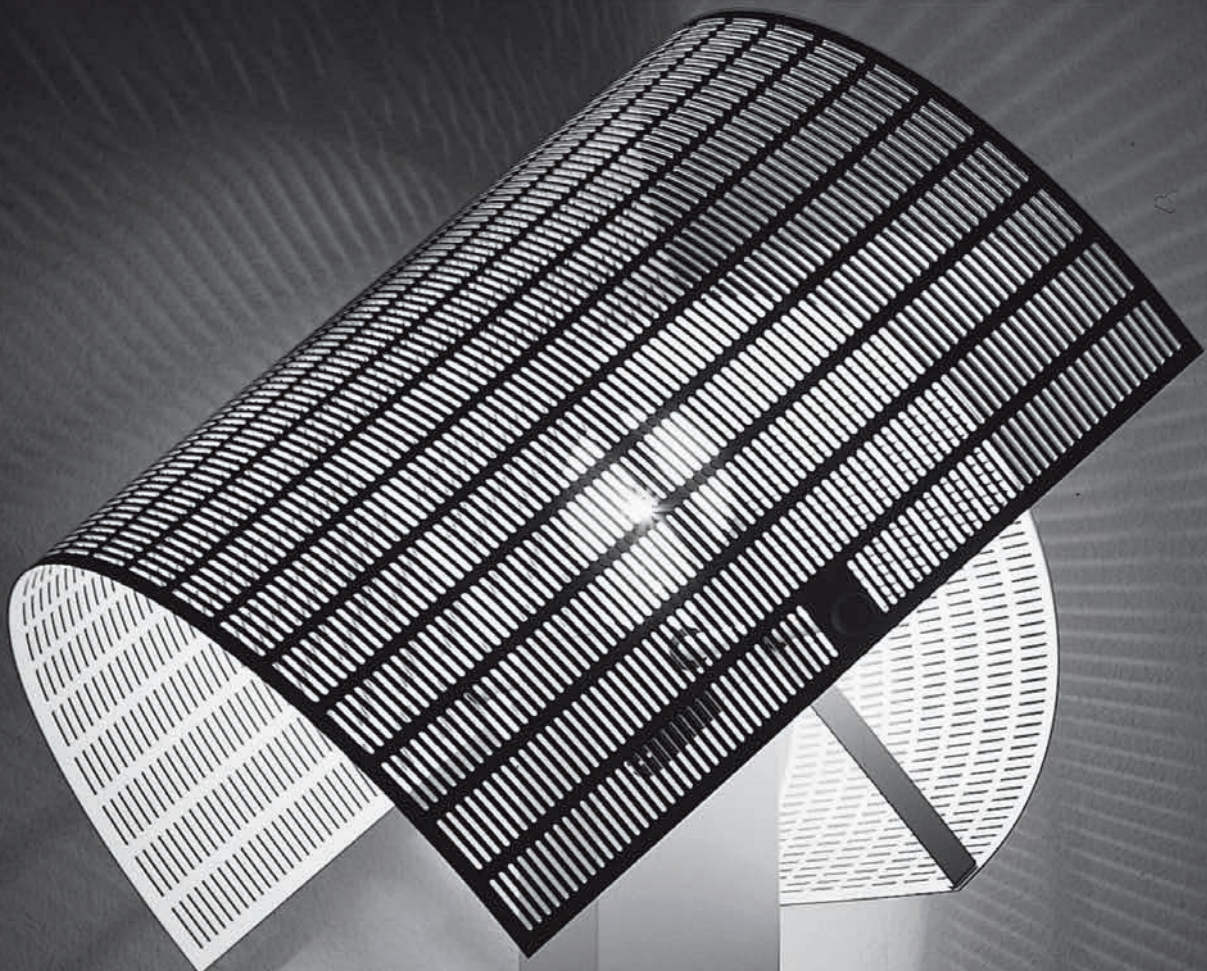

Photo by Aldo Ballo, 1986

Chimera Mezzachimera

Vico Magistretti
1969

Materiali

Base in metallo verniciato; struttura/diffusore in metacrilato opalino curvato a caldo.

Materials

Base in painted metal; structure/diffuser in heat-curved opal methacrylate.

Matériaux

Base en métal verni ; structure/diffuseur en méthacrylate opalin courbés à chaud.

Materialien

Sockel aus lackiertem Metall; Rahmen/Leuchtschirm aus opalem Methacrylat, heiß gebogen.

Materiales

Base de metal pintado; estructura/difusor de metacrilato opalino curvado en caliente.



Light emission



Colours



White



LED







"Un lavoro di luce per la luce: nasce un po' alla volta e poi prende forma: un pieno che sembra anche vuoto e si riempie di luce." Mimmo Paladino

E' una lampada scultura dalla doppia essenza che nasce dal lavoro di Mimmo Paladino per "Quijote": fortemente presente ma anche incorporea, diventa sogno e suggestione grazie alla luce.

Materiali

ABS, alluminio

Specificità

Le ottiche nascoste nel corpo della scultura definiscono un'emissione wall washer.

"A work of light for light: it comes to life gradually, then takes shape: a full that looks empty and is filled with light."

Mimmo Paladino

This sculptural lamp with a dual essence originates from the work of Mimmo Paladino for "Quijote": a strong, yet ethereal presence, it turns into dream and suggestion through light.

Materials

ABS, aluminum

Specificity

The optical units concealed within the body of the sculpture produce a wall washer emission.

"Un travail de la lumière pour la lumière : elle naît petit à petit puis elle prend forme : un plein qui semble aussi vide et se remplit de la lumière." Mimmo Paladino

C'est une lampe-sculpture à la double nature qui naît du travail de Mimmo Paladino pour "Quijote" : fortement présente mais aussi incorporelle, elle devient un rêve et une suggestion grâce à la lumière.

Matériaux

ABS, aluminium

Spécificité

Les parties optiques cachées dans le corps de la structure définissent une émission wall washer.

"Eine Lichtarbeit für das Licht: Es entsteht Stück für Stück und nimmt dann Gestalt an: ein Ganzes scheint zugleich Leere und füllt sich mit Licht." Mimmo Paladino

Es handelt sich um eine Leuchtenskulptur mit doppeltem Wesen, welches aus der Arbeit von Mimmo Paladino für "Quijote" entstanden ist: eine starke Präsenz aber zugleich körperlos. Aufgrund des Lichts wird sie zum Traum und zur Suggestion.

Materialien

ABS, Aluminium

Spezifikation

Die im Körper der Struktur versteckten Leuchten definieren eine Wall Washer-Lichtemission.

"Un trabajo de luz para la luz: nace un poco a la vez y luego toma forma: algo lleno que también parece vacío y se llena de luz."

Mimmo Paladino

Es una lámpara escultura con una doble esencia que nace del trabajo de Mimmo Paladino para "Quijote": fuertemente presente pero también incorpórea, se convierte en sueño y sugestión gracias a la luz.

Materiales

ABS, aluminio

Especificaciones

Las ópticas ocultas en el cuerpo de la escultura definen una emisión wall washer.

Light emission



Colours



White

Montjuic

Santiago Calatrava
1990

Materiali

Struttura in resina poliuretanica espansa verniciata;
diffusore in metacrilato opalino bianco.

Materials

Structure in painted foamed polyurethane; white opaline
methacrylate diffuser.

Matériaux

Structure en résine polyuréthane expansé vernie ;
diffuseur en méthacrylate opalin blanc.

Materialien

Struktur aus lackiertem Polyurethanharz; Schirm aus opal
weißem Methacrylat.

Materiales

Estructura de resina de poliuretano rígido; difusor
en metacrilato opalino blanco.

Light emission



Colours

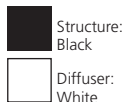



Photo by Aldo Ballo, 1990

Materiali

Base in acciaio verniciato effetto "soft touch"; stelo rivestito da una guaina di silicone platinico naturale (anti ingiallimento); diffusore in policarbonato trasparente verniciato effetto gomma; lente trasparente; riflettore interno in alluminio speculare con microforature irregolari.

Specificità

Costituita da un unico tubo d'acciaio, formato da una parte rigida inferiore e da una flessibile superiore. Dimmer posto lungo lo stelo.

Materials

Painted steel base with "soft touch" effect; stem covered by a natural platinic silicone sheath (antiyellowing); diffuser in transparent polycarbonate with rubber effect coating; transparent lens; internal reflector made of specular aluminium with random perforations.

Specification

The body lamp is a single tubular steel structure, composed of a rigid lower part and an flexible upper part. Touch dimmer on the stem.

Matériaux

Base en acier verni peint effet 'soft touch'; tige revêtue d'une gaine en silicone naturelle transparente (anti jaunissement); diffuseur en polycarbonate verni transparent; réflecteur interne en aluminium spéculaire comprenant de petites perforations.

Spécificité

Constitué d'un tube en acier rigide dans sa partie inférieure et flexible dans sa partie supérieure. Variateur sensitif placé sur la tige.

Materialien

Sockel aus lackiertem Stahl mit Soft Touch-Effekt; Stab mit transparentem, platinisiertem und gegen Vergilben geschütztem Silikon überzogen; Leuchtenkopf aus gummiartig anmutendem, transparentem Polycarbonat; transparente Linse; Innenreflektor aus verspiegeltem Aluminium.

Spezifikation

Der röhrenförmige Leuchtenkörper besitzt eine Struktur aus Stahl, deren unterer Teil unbeweglich während der obere flexibel und ausricht-bar ist. Lichtaustritt durch unterschiedliche Positionen zu verändern.

Materialies

Base en acero pintado efecto "soft touch"; tija revestida por una funda de silicona natural (antioxidante); difusor en policarbonato transparente pintado efecto goma; lente transparente; reflector interno en aluminio "Speculare" con micro agujeros irregulares.

Especificaciones

Está constituida por un único tubo de acero, formado por una pared rígida inferior y de una flexible superior. Encendido mediante la modalidad touch para la regulación de la intensidad luminosa colocado a lo largo del asta.

Awards**Pipe**

2006 – Reddot Award Product Design
"Best of the best"
Essen (Deutschland)

2008 – Designpreis der Bundesrepublik Deutschland
Frankfurt (Deutschland)

Pipe suspension

2004 – Compasso d'Oro / A.D.I.
Milano (Italia)

Intel Design 2003

Categoria Design "Augusto Morello"
Selezione alla III edizione 2003
Milano (Italia)

2004 – Design Plus, Light + Building
Frankfurt am Main (Deutschland)

Museums

Design Collection of the Museum
of Modern Art – New York (USA)

Pipe LED floor**Light emission****Colours**

Body:
Transparent satin



Base:
Black

Pipe LED wall/ceiling**Light emission****Colour**

Transparent satin

Pipe LED suspension**Light emission****Colour**

Transparent satin



Pipe LED floor



Pipe LED wall



Pipe LED suspension

Aggregato

Aggregato saliscendi

Enzo Mari
Giancarlo Fassina
1976

Materiali

Rosone in resina termoplastica e metallo verniciati; contrappeso in resina termoplastica trasparente; diffusori conici in metacrilato o metallo; diffusori sferici in metacrilato.

Specificità

Lampada con diffusori intercambiabili. Disponibile con cavo fisso o saliscendi con contrappeso.

Materials

Ceiling rose in thermoplastic resin and metal, painted; counterweight in thermoplastic transparent resin; cone-shaped diffuser in methacrylate or in metal; sphere-shaped diffuser in methacrylate.

Specification

Lamp with interchangeable diffusers. Available with fixed cable or rise and fall counterweight.

Matériaux

Rosace en résine thermoplastique et métal verni ; contrepoids en résine thermoplastique transparente; diffuseurs coniques en méthacrylate ou en métal ; diffuseurs sphériques en méthacrylate.

Spécificité

Suspension avec diffuseurs interchangeableables. Disponible avec câble fixe ou monte et baisse avec contrepoids.

Materialien

Baldachin aus Kunstharz und Metall, lackiert; Gegengewicht aus transparentem Kunstharz; kegelförmiger Schirm aus Methacrylat oder aus Metall; kugelförmiger Schirm aus Methacrylat.

Spezifikation

Die Schirme der Pendelleuchte sind austauschbar. Auf Wunsch mit höhenverstellbarem Kabel erhältlich.

Materialies

Rosetón, de resina termoplástica y metal pintados; contrapeso de resina termoplástica transparente; difusores cónicos de metacrilato o metal; difusores esféricos de metacrilato.

Especificaciones

Lámpara con difusores intercambiables. Está disponible con cable fijo o de sube y baja, con contrapeso.

Light emission



Colours



Polished white



Anthracite grey
(cone only)



White
(sphere only)



Aggregato



LED



Awards

BIO 7 – Honourable Mention
1977 – Ljubljana (Slovenia)

Museums

Museo Permanente del Design Italiano
1945/1990 – Triennale di Milano
Milano (Italia)

Aggregato saliscendi

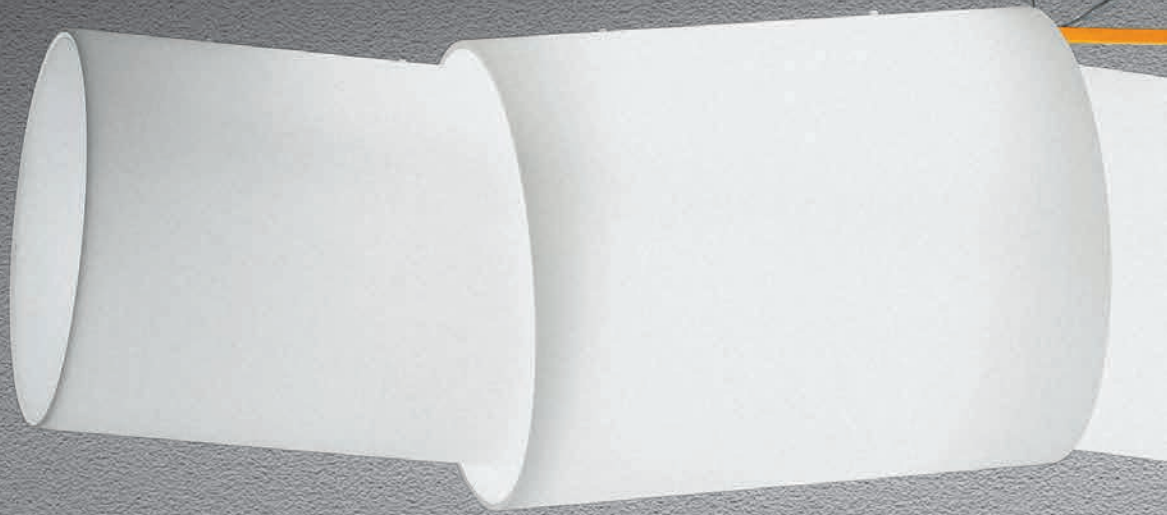

Light emission



Colours



White

**Materiali**

Struttura in acciaio; diffusore in vetro soffiato opalino.

Specificità

E' possibile applicare un filtro rosso all'elemento più piccolo del diffusore.

Materials

Steel structure; opal blown glass diffuser.

Specification

A red filter can be applied to the smallest diffuser module.

Matériaux

Structure en acier; diffuseur en verre soufflé opalin.

Spécificité

Possibilité d'appliquer un filtre rouge sur le plus petit diffuseur.

Materialien

Struktur aus Stahl, Lichtverteiler aus mundgeblasenem Opalglas.

Spezifikation

Wahlweise Anbringung eines roten Filters am kleinsten Schirmelement möglich.

Materiales

Estructura en acero; difusor en cristal soplado opalino.

Especificaciones

Posibilidad de aplicar un filtro rojo al elemento más pequeño del difusor.

Pantalica

Pantalica 2 wall, 3 wall

Örni Halloween
1995

Materiali

Bracci e coppette in vetro soffiato; tige in acciaio cromato lucido.

Specificità

Nella versione sospensione, tige regolabile in altezza.

Materials

Arms and bowls in blown glass; polished chrome-plated steel rod.

Specificity

Pantalica suspension: rigid rod adjustable for different ceiling heights.

Matériaux

Bras et coupelles en verre soufflé ; tige en acier chromé.

Spécificité

Pantalica suspension : tige rigide, adaptable aux différentes hauteurs de plafond.

Materialien

Arme und Schalen aus transparentem mundgeblasenen Glas; Pendelstab aus poliertem Chromstahl.

Spezifikation

Pantalica suspension: Höhenverstellbarer Stab.

Materiales

Metal y cristal soplado; brazos y copas de cristal soplado; tija de acero cromado.

Especificaciones

La versión de suspensión tiene una tija regulable en altura.



Light emission



Colours



Rod:
Mirror



Body and diffusers:
Black



Body and diffusers:
White



LED



Hsiang

Mimmo Paladino
2016

"Il mio nome è Hsiang. Sono il custode dei libri, che sono forse gli ultimi giacché nulla sappiamo dell'Impero e del Figlio del Cielo." Jorge Luis Borges - Il guardiano dei libri

Materiali

Alluminio, acciaio, policarbonato

Specificità

Quattro colori LED illuminano i nomi dei più grandi autori internazionali.

"My name is Hsiang. I am the keeper of the books, these books which are perhaps the last, for we know nothing of the Son of Heaven or of the Empire's fate." Jorge Luis Borges - The Keeper Of The Books

Materials

Aluminum, steel, polycarbonate

Specification

Four LED colors light up the names of the largest international authors.

"Mon nom est Hsiang. Je suis celui qui garde les livres, ces livres qui sont peut-être les derniers, parce que nous ne savons rien de l'Empire ni du Fils du Ciel." Jorge Luis Borges - Le gardien des livres

Matériaux

Aluminium, acier et polycarbonate

Spécificité

Quatre couleurs de LED illuminent les noms des plus grands auteurs internationaux.

"Mein Name ist Hsiang. Ich bin der Hüter der Bücher, Diese Bücher, die vielleicht die letzten sind, denn wir wissen nichts von dem Sohn des Himmels oder vom Schicksal des Imperiums." Jorge Luis Borges - Der Hüter der Bücher

Materialien

Aluminium, Stahl, Polycarbonat

Spezifikation

Vier LED-Farben leuchten die Namen der größten internationalen Autoren auf.

MARXOMEROE

Light emission



Colours





LED

ARLOSTOBORGESCALVINO
LIOTBUZZATI BOCCACCIOPROUSTKA
JOYCELEOPARDIDANTEPOE

Prometeo LED

Aldo Rossi

1996

Materiali

Acciaio verniciato; schermi diffusori in metacrilato opalino.

Specificità

Tre proiettori con i filtri dicroici rosso, verde e blu consentono di ottenere infinite atmosfere di luce colorata e un quarto proiettore produce luce bianca. Attraverso un telecomando è possibile selezionare 12 atmosfere standard, crearne e memorizzarne ulteriori 86 e agire sull'intensità luminosa.

Materials

Matt laquered steel; diffuser screens in opaline methacrylate.

Specification

Three projectors with red, green and blue dichroic filters allow the creation of a wide range of coloured light atmospheres while a fourth projector emits white light. Using a remote control the user can select 12 standard atmospheres, create and save other 86 and adjust the light intensity.

Matériaux

Acier verni mat ; écrans diffuseurs en métacrylate opalin.

Spécificité

Trois projecteurs avec filtres dichroïques rouge, vert et bleu permettent d'obtenir de nombreuses atmosphères colorées ; un quatrième projecteur produit la lumière blanche.

A l'aide de la télécommande, il est possible de sélectionner 12 atmosphères standard, d'en créer et d'en mémoriser 86 autres et d'agir sur l'intensité lumineuse.

Materialien

Mattlackierter Stahl; Lichtfenster aus opalem Methacrylat.

Spezifikation

Drei Strahler mit dichroitischem Filter in den Grundfarben Rot, Blau und Grün, erschaffen unzählige farbige Lichtstimmungen. Über ein viertes Element wird Weißlicht erzeugt.

Diese Lichtstimmungen sind über eine Fernbedienung abrufbar (12 Standardlichtstimmungen, 86 Einstellungen bzgl. der Lichtintensität).

Materiales

Acero pintado opaco; pantallas difusor en de metacrilato opalino.

Especificaciones

Tres proyectores con filtros dicroicos, rojo, verde y azul permiten obtener infinitas atmósferas de luz coloradas y el cuarto proyector produce luz blanca. Mediante un mando a distancia es posible manejar 12 atmósferas estándar, crear y memorizar otras 86 y actuar en la intensidad luminosa.

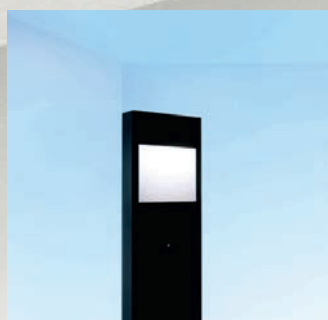
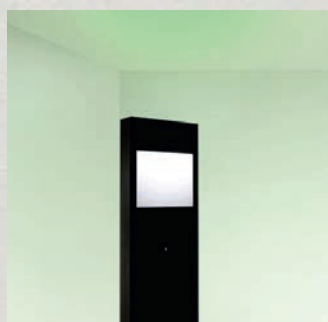

Light emission



Colours



Infrared remote control
(included)

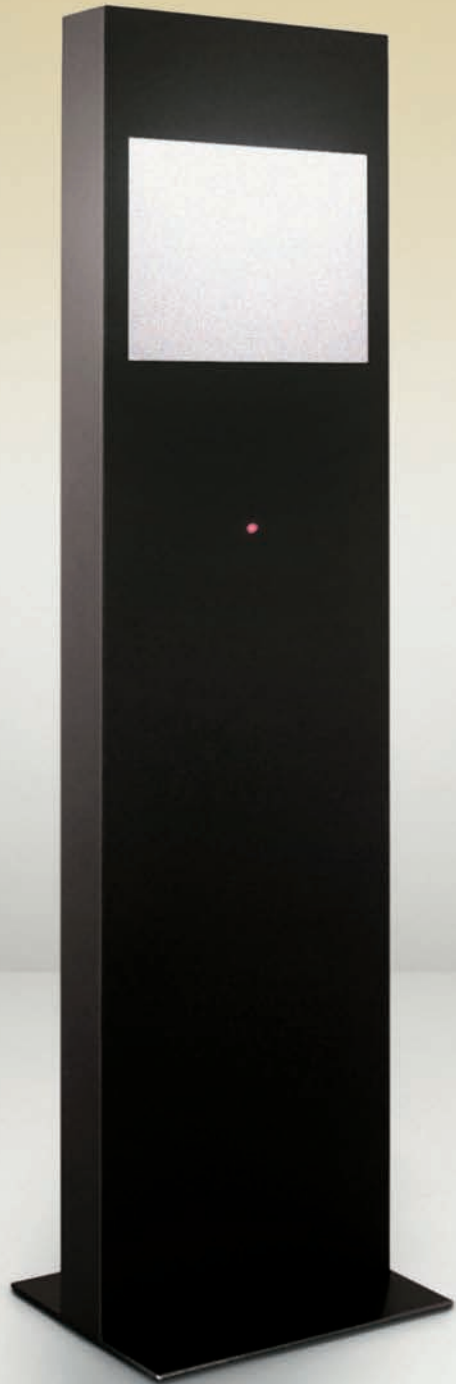

Yang
Yang LED

Carlotta de Bevilacqua
2000



**Materiali**

Acciaio verniciato; schermi diffusori in metacrilato opalino.

Specificità

Sei piedini permettono di regolare il posizionamento con diverse inclinazioni. Tre proiettori con i filtri dicroici rosso, verde e blu consentono di ottenere infinite atmosfere di luce colorata. Attraverso un telecomando è possibile gestire 10 atmosfere standard, crearne e memorizzarne ulteriori 10 e agire sull'intensità luminosa. Un display nella lampada visualizza l'atmosfera selezionata.

Materials

Methacrylate structure and transparent polycarbonate case.

Specification

Six small feet allow the lamp to be placed at different inclinations. Three projectors with dichroic filters red, green and blue allow to create a wide range of light coloured atmospheres. It is possible, using a remote control, to manage 10 standard atmospheres, to create and memorise, other 10 and to adjust the light intensity. A display on the lamp shows the selected atmosphere.

Matériaux

Structure en méthacrylate et polycarbonate transparent.

Spécificité

Six pieds permettent de placer la lampe dans différentes positions. Trois projecteurs avec filtres dichroïques rouge, vert et bleu permettent d'obtenir nombreuses atmosphères de lumière colorées. A l'aide de la télécommande, il est possible de gérer 10 atmosphères standard, d'en créer et d'en mémoriser 10 autres et d'agir sur l'intensité lumineuse.

Materialien

Struktur aus Methacrylat und transparentem Polycarbonat.

Spezifikation

Die sechs Füße ermöglichen eine unterschiedliche Positionierung der Leuchte. Drei Strahler mit dichroitischen Filter, in den Grundfarben Rot, Blau und Grün erzeugen unzählige farbige Lichtstimmungen. Über eine Fernbedienung lassen sich 10 Standard-Lichtstimmungen abrufen sowie weitere 10 zur Einstellung der Lichtintensität. Ein Display visualisiert die ausgewählte Lichtstimmung.

Materiales

Estructura en metacrilato y policarbonato transparente.

Especificaciones

Seis piecitos permiten regular la posición con distintas inclinaciones. Tres proyectores con los filtros dicroicos rojo, verde y azul permiten obtener infinitas atmósferas de luz colorada. Mediante un mando a distancia es posible gestionar 10 atmósferas standard, crear y memorizar 10 más y gestionar la intensidad luminosa. Un display en la lámpara visualiza la atmósfera seleccionada.

Light emission**Colours**

Infrared
remote control
(included)





Materiali

Acrilico opalino.

Specificità

Utilizza sorgenti RGB che consentono di ottenere infinite atmosfere di luce colorata. Attraverso un telecomando è possibile gestire 10 atmosfere standard, crearne e memorizzarne ulteriori 10 e agire sull'intensità luminosa. Un display posto sulla base visualizza l'atmosfera selezionata. In prossimità della base è posta una luce blu di presenza.

Materials

Opal acrylic.

Specification

The fitting uses RGB sources allowing the creation of a wide range of coloured light atmospheres. Using a remote control the user can manage 10 standard atmospheres, create and save 10 more and adjust the light intensity. The selected atmosphere can be visualized on a display located on the base of the fitting. A blue light near the base marks the presence of the lamp.

Matériaux

Acrylique opalin.

Spécificité

Il utilise des sources RGB, qui permettent d'obtenir de nombreuses atmosphères colorées. A l'aide de la télécommande, il est possible de gérer 10 atmosphères standard, d'en créer et d'en mémoriser 10 autres et d'agir sur l'intensité lumineuse. Un écran sur la base, visualise l'atmosphère sélectionnée. Une lumière bleue près de la base signale la présence de la lampe.

Materialien

Opales Acryl.

Spezifikation

Durch den Einsatz von RGB-Lampen lassen sich verschiedenste farbige Lichtstimmung kreieren, die über eine Fernbedienung abrufbar sind (10 Standard-Lichtstimmungen, 10 individuell einstellbare Lichtstimmungen sowie Wahl der Lichtintensität). Ein Display am Sockel visualisiert die ausgewählte Lichtstimmung. Die im unteren Bereich installierte blaue Leuchte signalisiert die Präsenz.

Materiales

Acrílico opalino.

Especificaciones

Incorpora fuentes de luz RGB, que permiten obtener infinitas atmósferas de luz coloradas. Mediante un mando a distancia es posible manejar 10 atmósferas estándar, crear y memorizar otras 10 y actuar en la intensidad luminosa. Un display contenido en el pie de la lámpara expone la atmósfera seleccionada. Una luz azul marino cerca del pie indica la presencia de la bombilla.

Light emission



Colour



Infrared
remote control
(included)



IN-EI

ISSEY MIYAKE



596
MENDORI



596
MENDORI
mini



598
MOGURA
mini



600
YADOKARI



601
FUKUROU



602
MINOMUSHI
floor



603
MINOMUSHI
suspension



604
TATSUNO-
OTOSHIGO



605
WUNI

Awards

2014 – Compasso d'Oro / A.D.I.
Milano (Italia)

2013 – Reddot Design Award
Essen (Deutschland)

2013 – iF Product Design Award Gold
Deutschland

IN-EI ISSEY MIYAKE realizzata da Artemide è una collezione di lampade a sospensione, da tavolo e da terra; le ombre create dalle lampade sono percorse da sottili e bellissime sfumature luminose. Le pieghe inimitabili che determinano le forme plastiche e la solidità delle lampade sono realizzate con una tecnologia originale creata da Issey Miyake. Grazie al materiale riciclato, dalla trasparenza luminosa superiore a quella della carta, le lampade mantengono perfettamente la loro forma senza richiedere strutture interne: il processo di piegatura, infatti, crea volumi sufficientemente solidi, che possono essere rimodellati senza problemi. Quando non sono utilizzate le lampade possono essere conservate piegate. "Sono particolarmente orgoglioso di questa collaborazione", afferma Ernesto Gismondi; "Issey Miyake dedica il proprio eccezionale impegno artistico a una ricerca attenta alle esigenze dell'uomo e della sua vita: lo stesso impegno si riconosce in The Human Light, la filosofia che guida la missione Artemide. Con Miyake si è trattato quindi innanzitutto di una sintonia di valori e di visione". IN-EI" in giapponese significa "ombra, ombreggiatura, sfumatura" e la ricerca è iniziata nel 2010 al Miyake Design Studio quando un nuovo processo fu sviluppato da Jun Mitani usando un programma matematico con formule geometriche tridimensionali.

"132 5. ISSEY MIYAKE" è un metodo geniale per creare abiti e costituisce un esempio di ciò cui può giungere la ricerca sui materiali tessili e sulle tecnologie. Infatti il progetto si avvale di un tessuto speciale capace di assumere e mantenere forme in 3D partendo da un singolo pezzo di tessuto. IN-EI ISSEY MIYAKE è nato dall'incontro tra la competenza Artemide nel mondo della luce e l'approccio innovativo del Reality Lab. verso i materiali e il design.

Artemide's IN-EI ISSEY MIYAKE is a collection of suspended, table and floor lamps; the shadows cast by the lamps are combined with subtle, beautiful nuances of light.

The unique folds creating the shapes and the durability of the shades are the result of an innovative technology developed by Issey Miyake. Thanks to a recycled material featuring a higher transparency to light than paper, the plasticity of the lampshades is perfectly achieved without need for internal structures: the process of folding actually creates volumes which are solid enough to be easily remodelled. When not in use, the lamps can be folded and stored. "I'm particularly proud of this collaboration," says Ernesto Gismondi. "Issey Miyake devotes his exceptional artistic talents to a research focused on the needs and lives of the individuals: the same commitment can be seen in The Human Light, Artemide's leading philosophy. So our values and vision were in tune with Issey Miyake from the very beginning." IN-EI it means "shadow, shading, nuance" in Japanese; the project started in 2010 at the Miyake Design Studio when Jun Mitani created a new process using a computer software based on 3D geometric formulae.

"132 5. ISSEY MIYAKE" is a clever method of creating clothing and represents an successful example of what can be achieved through thorough research into textiles and technology. The IN-EI project uses a special fabric that can be folded to create and retain three-dimensional shapes. IN-EI ISSEY MIYAKE was created through the partnership between Artemide lighting know-how and Reality Lab innovative approach to materials and design.

陰翳
 IN-EI
 ISSEY MIYAKE



Issey Miyake
 photo by Brigitte Lacombe

Issey Miyake

After studying graphic design at the Tama Art University in Tokyo (1964), Issey Miyake (born in Hiroshima in 1938) moved to Paris (1966-68), where he worked as an apprentice with G. Laroche and H. de Givenchy. In 1971 he set up his own fashion house and presented the first collection under his name in New York. Since the early seventies, Miyake has been carrying out research into materials and design techniques at his Tokyo studio. Out of this came his rigid plastic bustiers, gowns made of oilcloth and later, in the early nineties, his celebrated pleated garments. In Paris the Fondation Cartier staged a retrospective of his work entitled Issey Miyake Making Things (1999). In his creations traditional Oriental elements are fused with technologies and high-tech materials typical of the West.



Issey Miyake Exhibition: The Work of Miyake Issey Installation view at the National Art Center, Tokyo
Photo by Masaya Yoshimura

Uno spazio vuoto.
An empty space.

1

Il pezzo unico di tessuto
da cui nasce ogni creazione.

The one-piece fabric
used for each product.

3

La tridimensionalità.

Refers to 3D.

2

Inizialmente il tessuto è piegato
in forma bidimensionale.

Comes from the 2D initial folding
process.

4

5

La metamorfosi delle forme piegate
quando divengono abito o oggetto.

The metamorphosis turning folded shapes
into clothing or objects.

IN-EI ISSEY MIYAKE réalisée par Artemide est une collection de suspensions, lampes de table et lampadaire ; les ombres créées par les lampes sont parcourues par des subtiles et très belles nuances lumineuses. Les plis inimitables qui déterminent les formes plastiques et la solidité des lampes sont réalisés avec une technologie originale créée par Issey Miyake. Grâce au matériel recyclé, d'une transparence lumineuse supérieure à celle du papier, les lampes gardent une forme parfaite sans avoir besoin d'une structure interne : le processus de pliage, en effet, crée des volumes suffisamment solides qui peuvent être modelés sans aucun problème. Quand elles ne sont pas utilisées les lampes peuvent être repliées et ainsi conservées. « Je suis particulièrement fier de cette collaboration », affirme Ernesto Gismondi, « Issey Miyake consacre son exceptionnel engagement artistique à une recherche attentive aux exigences de l'Homme et de sa vie : le même engagement est reconnaissable dans The Human Light, la philosophie qui guide la mission d'Artemide. Avec Miyake il a été question donc tout d'abord d'un partage de valeurs et de vision ». IN-EI en japonais signifie « ombre, obscurité, nuance » et la recherche a débuté en 2010 au Miyake Design Studio pendant qu'un nouveau processus a été développé par Jun Mitani en utilisant un programme mathématique avec des formules géométriques tridimensionnelles. « 132 5. ISSEY MIYAKE » est une méthode révolutionnaire pour créer des vêtements et constitue un exemple de ce que l'on arrive à réaliser à travers la recherche sur les textiles et les technologies. Le projet en effet se base sur un tissu spécial capable de structurer et garder des formes en 3D tout en partant d'un seul morceau de tissu. IN-EI ISSEY MIYAKE est né de la rencontre entre les compétences d'Artemide dans le secteur de l'éclairage et l'approche innovatrice du Reality Lab concernant les matériaux et le design.

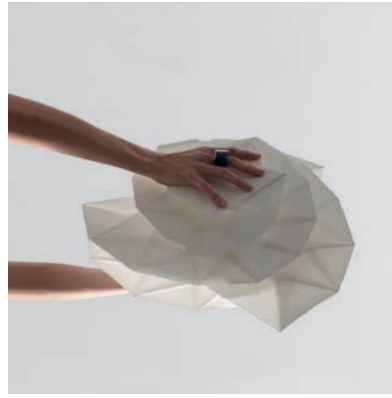

Die Artemide-Kollektion IN-EI ISSEY MIYAKE besteht aus Pendel-, Tisch- und Stehleuchten. Die von den Leuchten erzeugten Schatten, werden von zarten, wunderschönen Lichtnuancen durchzogen. Die unnachahmlichen Falten, die die plastische Form und Stabilität der Leuchten bestimmen, werden mit einer eigens von Issey Miyake entwickelten Technik hergestellt. Durch das recycelte PET-Material, das eine höhere Lichtdurchlässigkeit als Papier aufweist, behalten die Leuchten auch ohne Innenrahmen exakt ihre Form. Das Falten des Materials führt nämlich zu stabilen Konstruktionen, die problemlos wieder neu geformt werden können. Wenn die Leuchten nicht eingesetzt werden, können sie flach zusammengefaltet aufbewahrt werden. „Ich bin auf diese Zusammenarbeit besonders stolz“, bestätigt Ernesto Gismondi. „Issey Miyake stellt sein außerordentliches künstlerisches Engagement in den Dienst der sorgfältigen Erforschung der Bedürfnisse des Menschen und seines Lebens. Dasselbe Engagement liegt auch der Philosophie The Human Light zugrunde, zu der Artemide sich verpflichtet hat. Mit Miyake gab es vor allem in den Werten und der Sichtweise eine große Übereinstimmung.“ Das japanische „IN-EI“ heißt so viel wie „Schatten, Schattenreichtum, Schattierung“; das Forschungsprojekt begann 2010 im Miyake Design Studio, als Jun Mitani auf der Grundlage eines Mathematikprogramms mit dreidimensionalen geometrischen Formeln ein neues Verfahren entwarf.

„132 5. ISSEY MIYAKE“ beschreibt eine geniale Methode zur Herstellung von Kleidungsstücken und ist ein Beispiel dafür, was Forschung bei Textilmaterialien und in der Technologie leisten kann. Und in der Tat bedient sich dieses Projekt einer speziellen Faser, die - ausgehend von einem einzigen Stück Stoff - in der Lage ist, dreidimensionale Formen zu bewahren. IN-EI ISSEY MIYAKE ist aus dem Zusammenspiel der Lichtkompetenz von Artemide und dem innovativen Ansatz von Reality Lab gegenüber Materialien und Design entstanden.

IN-EI ISSEY MIYAKE realizada por Artemide es una colección de lámparas de suspensión, sobremesa y de pie; las sombras creadas por las lámparas se manifiestan a través de manchas sutiles y bellas de la luz. Gracias al material reciclado, desde la transparencia luminosa superior a la del tejido, las lámparas mantiene perfectamente su forma sin necesitar estructuras internas: el proceso de plegado, de hecho, crea volúmenes suficientemente sólidos, que pueden ser remodelados sin problemas. Cuando las lámparas no se utilizan se pueden conservar plegadas. „Estoy particularmente orgulloso de esta colaboración“ afirma Ernesto Gismondi; „Issey Miyake dedica su propio tiempo de creación a una búsqueda que se fija en las exigencias del hombre y de su vida; el mismo empeño se reconoce en The Human Light, al filosofía que guía la misión Artemide. Con Miyake se ha tratado sobre todo de una sintonía de valores y visión“. IN-EI en japonés significa “sombra, sombreado, matices” y la búsqueda empieza en el 2010 en el Estudio Miyake Design cuando un nuevo proceso se desarrolla por Jun Mitani usando un programa matemático con fórmulas geometrías tridimensionales.

“132 4. ISSEY MIYAKE“ es un método genial para cera ropa y constituye un ejemplo de y constituye un ejemplo de lo que puede lograrse a través de la investigación de los textiles y las tecnologías. De hecho, el proyecto IN -EI hace uso de un tejido especial que se puede plegar para asumir y mantener las formas tridimensionales. IN -EI ISSEY MIYAKE nació del encuentro entre la experiencia de Artemide en el ámbito de la iluminación y el enfoque innovador adoptado por el Laboratorio de Realidad hacia los materiales y el diseño.

MENDORI
MENDORI mini

Issey Miyake + Reality Lab.
2012, 2014

Awards

MENDORI
2013 – Delta Award for Industrial design
Deutschland, Nominierung





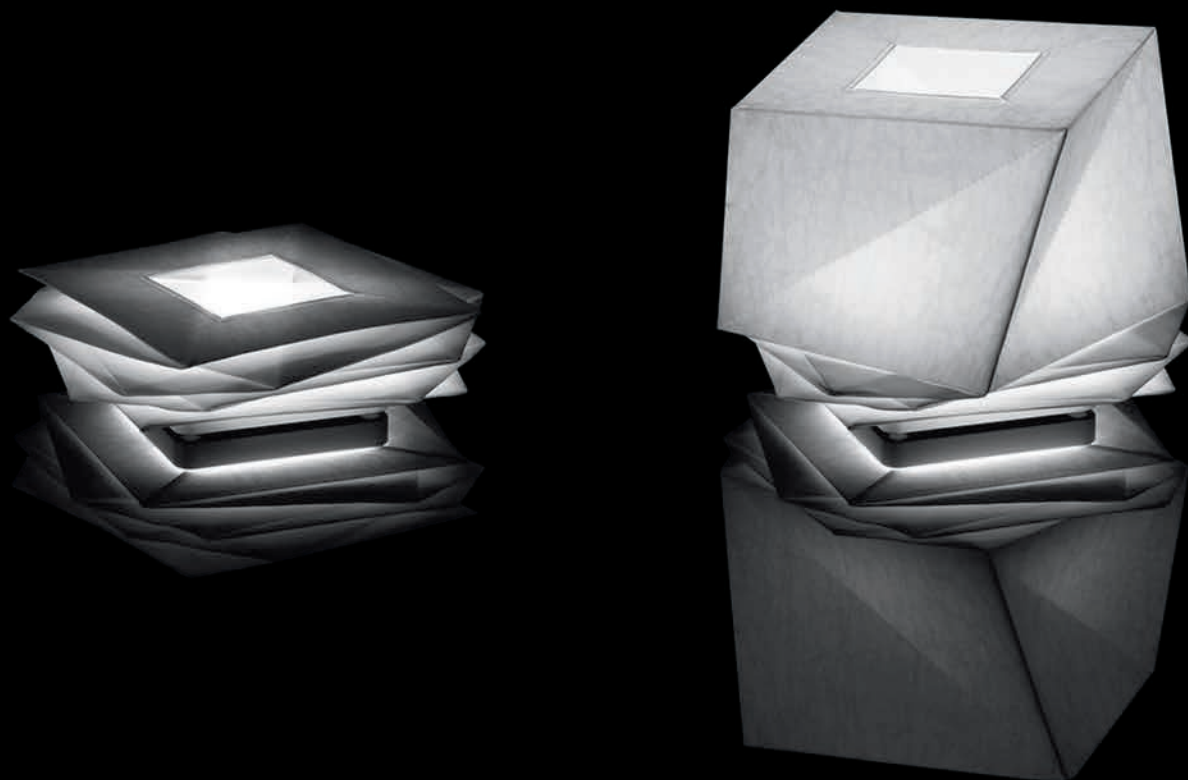



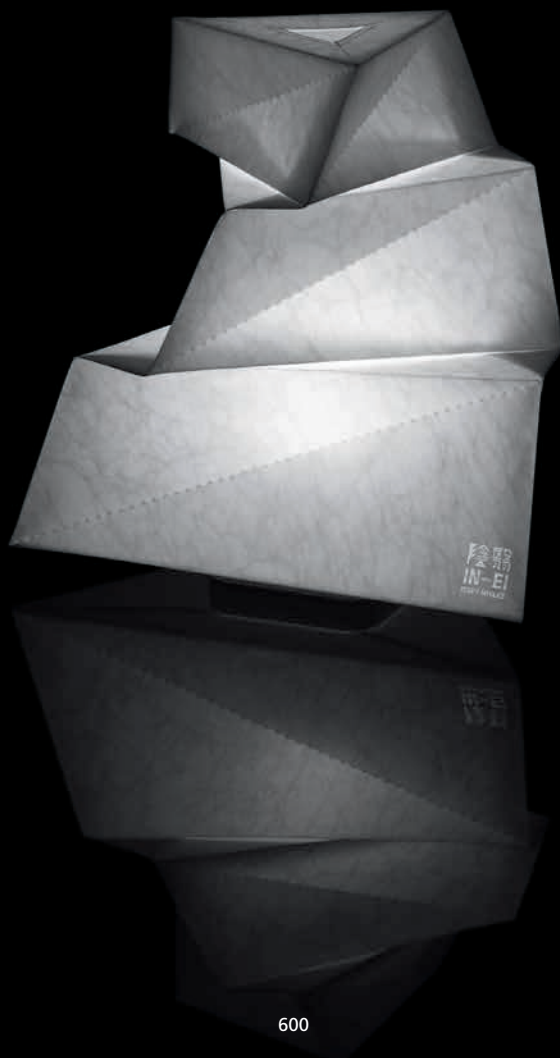

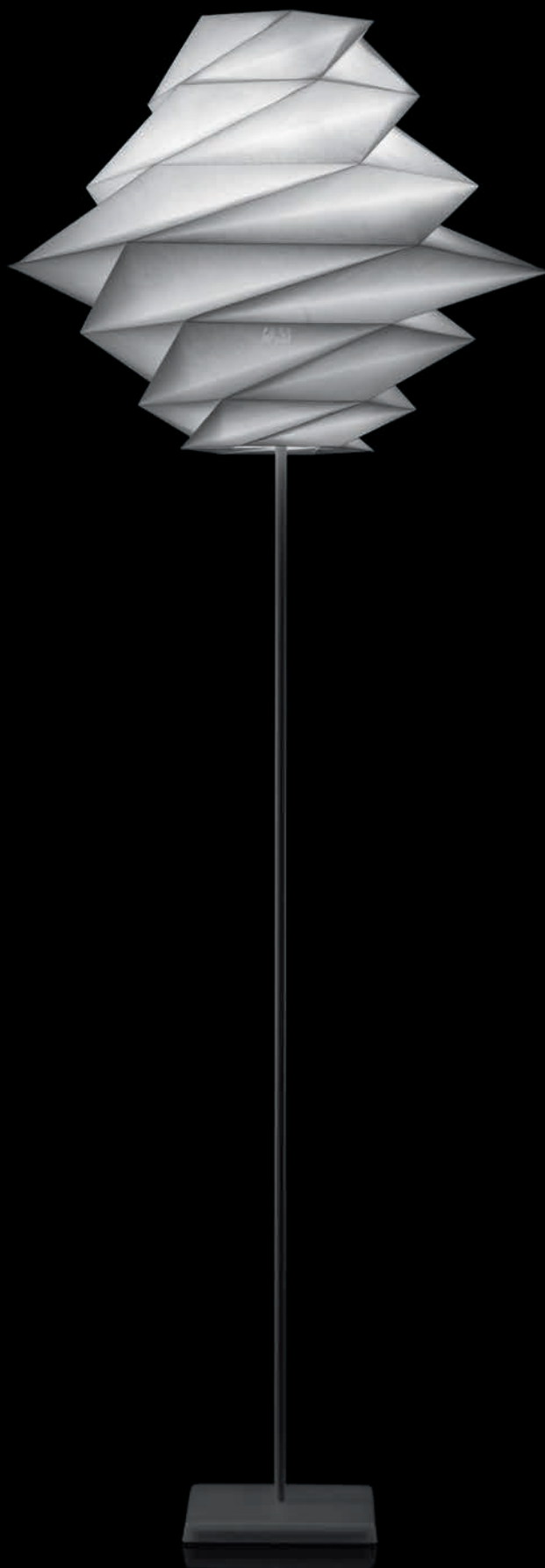



MINOMUSHI suspension

Issey Miyake + Reality Lab.
2012

陰翳
IN-EI
ISSEY MIYAKE





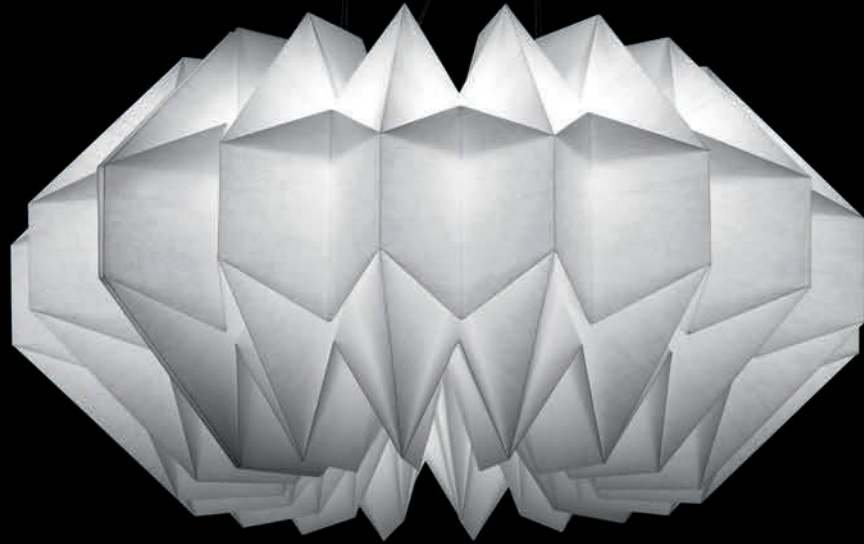



Fondation Cartier, "Mémoires vives", Paris 2014
Photo by Hervé Tarrieu



Schede tecniche

Technical Sheets
Fiche technique
Technische Spezifikation
Fichas técnicas



LED integrato non sostituibile
Not replaceable integrated LED source
LED intégrée non remplaçable
LED Leuchtmittel integriert
und nicht austauschbar
LED integrado no sustituible



Sorgente inclusa
Included source
Source incluse
Inkl. Leuchtmittel
Bombilla incluida



Sorgente esclusa
Excluded source
Source non incluse
Exkl. Leuchtmittel
Bombilla no incluida



Apparecchio dimmerabile tramite pulsante presente sulla lampada o sul cavo (infrarot, microswitch, push button, slider control, touch).

Dimmable fixture by means of a switch situated on the lamp structure or on cable (infrared, microswitch, push button, slider control, touch).

Appareil graduable au travers d'un bouton poussoir présent sur le corps de la lampe ou sur le câble (infrarouge, microswitch, bouton poussoir, curseur de contrôle, sensitif).

Mit integriertem Dimmer am Leuchtenkörper oder Dimmer am Kabel (Infrarot, Microswitch-Dimmer, Push-Dimmer, Schiebedimmer, Touch-Dimmer).

Luminaria regulable por medio de un pulsador presente en el cuerpo o en el cable de la lámpara (infrarrojo, microswitch, push button, slider control, touch).



Apparecchio dimmerabile tramite pulsante remoto adatto a gestire sorgenti dimmerabili (alogene, fluorescenti, LED retrofit).

Dimmable fixture by means of a remote switch able to manage dimmable sources (halogens, fluorescents, LED Retrofit).

Appareil graduable au travers d'un bouton poussoir déporté et adapté à gérer des sources graduables (halogène, fluorescente, Led retrofit).

Dimmbar unter Verwendung geeigneter Steuerungskomponenten (Halogen, Kompaktil., LED Retrofit).

Luminaria regulable mediante pulsador remoto apto para gestionar fuentes de iluminación regulables (halógenas, fluorescentes, LED retrofit).

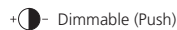

Apparecchio dimmerabile tramite pulsante remoto adatto a gestire driver di tipo Push.

Dimmable fixture by means of a remote switch able to manage Push Drivers.

Appareil graduable au travers d'un bouton poussoir déporté et adapté à gérer des alimentations de type Push.

Dimmbar unter Verwendung eines geeigneten Tasters, mindestens eine 4-adrige Zuleitung notwendig.

Luminaria regulable por medio de un pulsador remoto apto para gestionar drivers de tipo Push.



Apparecchio dimmerabile tramite pulsante remoto adatto a gestire driver di tipo 1-10V.

Dimmable fixture by means of a remote switch able to manage 1-10V Drivers.

Appareil graduable au travers d'un bouton poussoir déporté et adapté à gérer des alimentations de type 1-10V.

Dimmbar unter Verwendung geeigneter Steuerungskomponenten- mindestens 5-adrige Zuleitung notwendig (2-adrige Steuerleitung).

Luminaria regulable por medio de un pulsador remoto apto para gestionar drivers de tipo 1-10V.

Lampade da tavolo

Table lamps
Lampes de table
Tischleuchten
Lámparas de sobre-mesa

Castore 14

p. 124

HALO 1x48W (G9)
or LED 1x2,3W (G9)
Lamp not included

IP20   **EAC**

Energy Label n°30 (A++ → E)



Castore 25

p. 124

HALO 1x77W (E27)
or LED DIM 1x10W (E27)
Lamp not included

IP20   **EAC** 

+  - Dimmer

Energy Label n°30 (A++ → E)

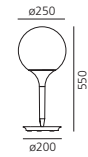

Castore 35

p. 124

HALO 1x150W (E27)
or LED DIM 1x21W (E27)
Lamp not included

IP20   **EAC** 

+  - Dimmer

Energy Label n°30 (A++ → E)

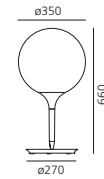

Choose

p. 110

HALO 1x57W (E27)
or LED 1x8W (E27)
Lamp not included

IP20   **EAC**

Energy Label n°30 (A++ → E)

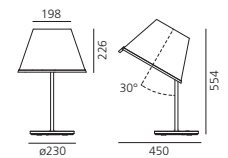

Dalù

p. 132

HALO 1x30W (E14)
or LED 1x4W (E14)
Lamp not included

IP20   **EAC** 

Energy Label n°30 (A++ → E)



Decomposé light

p. 134

LED 1x6W (E27)
or FLUO 1x8W (E27)
Lamp not included

IP20  **EAC**

Energy Label n°2 (A++ → A)

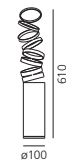

Demetra

p. 34

LED Total power 8W
Color temperature 2700K / 3000K
Lighting output 360lm / 385lm
CRI 90

IP20   **EAC**

+  - Dimmer

Energy Label n°1 (A++ → A)



Demetra MD



LED Total power 8W
Color temperature 3000K
Lighting output 385lm
CRI 90

IP20   **EAC**

+  - Dimmer

Energy Label n°1 (A++ → A)

Demetra micro

p. 34

LED Total power 6W
Color temperature 2700K / 3000K
Lighting output 241lm / 257lm
CRI 90

IP20   **EAC**

+  - Dimmer

Energy Label n°1 (A++ → A)

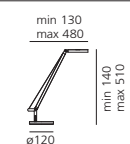

Demetra professional

p. 42

LED Total power 12W
Color temperature 3000K
Lighting output 960lm
CRI 90

IP20

+ - Dimmer

Energy Label n°1 (A++ → A)

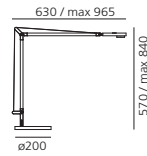

Dioscuri 14

p. 126

HALO 1x33W (G9)
or LED 1x2,3W (G9)
Lamp not included

IP20

Energy Label n°30 (A++ → E)



Dioscuri 25

p. 126

HALO 1x77W (E27)
or LED DIM 1x8W (E27)
Lamp not included

IP20

+ - Dimmer

Energy Label n°30 (A++ → E)



Dioscuri 35

p. 126

HALO 1x150W (E27)
or LED DIM 1x8W (E27)
Lamp not included

IP20

+ - Dimmer

Energy Label n°30 (A++ → E)



Dioscuri 42

p. 126

HALO 1x150W (E27)
or LED DIM 1x8W (E27)
Lamp not included

IP20

+ - Dimmer

Energy Label n°30 (A++ → E)

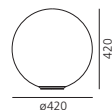

Eclittica 20 table

p. 100

LED Total power 10W
Color temperature 3000K
Lighting output 880lm
CRI 80

IP20

+ - Dimmer

Energy Label n°1 (A++ → A)

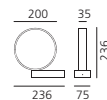

Empatia 16

p. 114

LED Total power 11W
Color temperature 3000K
Lighting output 567lm
CRI 90

IP20

+ - Dimmer

Energy Label n°1 (A++ → A)



Empatia 26

p. 114

LED Total power 20W
Color temperature 3000K
Lighting output 709lm
CRI 90

IP20

+ - Dimmer

Energy Label n°1 (A++ → A)



Empatia 36

p. 114

LED Total power 26W
Color temperature 3000K
Lighting output 1273lm
CRI 90

IP20

+ - Dimmer

Energy Label n°1 (A++ → A)



Equilibrat

p. 72

LED Total power 12W
Color temperature 3000K
CRI 90

Round head

Lighting output 240lm

Square head

Lighting output 380lm

IP20

+ - Dimmer

Energy Label n°1 (A++ → A)

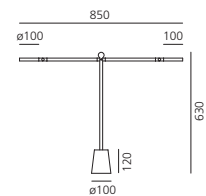

Fiamma

p. 104

1x8W LED (GU10)
Lamp not included

IP20

Energy Label n°9 (A+ → A)

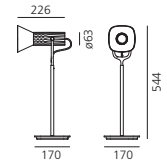

Halo

p. 96

LED Total power 13W
Color temperature 4000K
Lighting output 1140lm
CRI 80

IP20

+ - Dimmer

Energy Label n°1 (A++ → A)

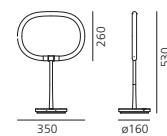

Ina

p. 80

LED Total power 11W
Color temperature 3000K
Lighting output 303lm
CRI 80

IP20

+ - Dimmer

Energy Label n°1 (A++ → A)

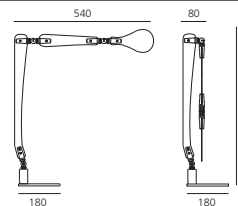

Ipparco

p. 92

LED Total power 8,5W
Color temperature 3000K
Lighting output 453lm
CRI 80

IP20

+ - Dimmer

Energy Label n°1 (A++ → A)

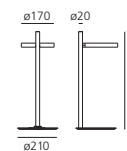

Laguna 16

p. 112

LED 1x8W (E14)
Lamp not included

IP20

Energy Label n°2 (A++ → A)



Laguna 26

p. 112

LED DIM 1x20W (E27)
Lamp not included

IP20

+ - Dimmer

Energy Label n°2 (A++ → A)



Laguna 37

p. 112

LED DIM 1x20W (E27)
Lamp not included

IP20

+ - Dimmer

Energy Label n°2 (A++ → A)

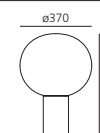

La Petite

p. 102

1x6W LED (E14)
Lamp not included

IP20  

Energy Label n°2 (A++ → A)

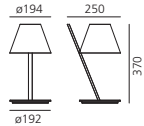
**Logico table**

p. 128

HALO max 3x46W (E27)
or LED DIM 3x9W (E27)
Lamp not included

IP20   

+  Dimmer

Energy Label n°30 (A++ → E)

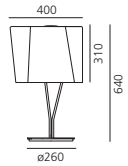
**Logico mini table**

p. 128

HALO 3x30W (E14)
or LED DIM 3x4W (E14)
Lamp not included

IP20   

+  Dimmer

Energy Label n°30 (A++ → E)

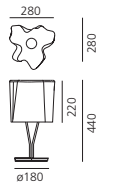
**Lotek**

p. 78

LED Total power 7,5W
Color temperature 3000K
Lighting output 288lm
CRI 80

IP20  

+  Dimmer

Energy Label n°1 (A++ → A)

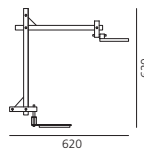
**Melampo**

p. 106

HALO 2x57W (E27)
or LED 2x8W (E27)
Lamp not included

IP20  

Energy Label n°30 (A++ → E)

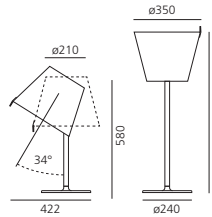
**Melampo notte**

p. 106

HALO 1x46W (E14)
or LED 1x6W (E14)
Lamp not included

IP20   

Energy Label n°30 (A++ → E)

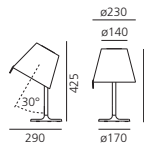
**Meteorite 15**

p. 120

HALO 1x33W (G9)
or LED 1x2,3W (G9)
Lamp not included

IP20  

Energy Label n°30 (A++ → E)

**Meteorite 35**

p. 120

HALO 1x150W (E27)
or LED DIM 1x8W (E27)
Lamp not included

IP20  

+  Dimmer

Energy Label n°30 (A++ → E)

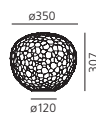
**Meteorite 48**

p. 120

HALO 1x150W (E27)
or LED DIM 1x8W (E27)
Lamp not included

IP20  

+  Dimmer

Energy Label n°30 (A++ → E)

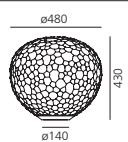
**Meteorite 15 stem**

p. 122

HALO 1x48W (G9)
or LED 1x2,3W (G9)
Lamp not included

IP20  

Energy Label n°30 (A++ → E)

**Meteorite 35 stem**

p. 122

HALO 1x150W (E27)
or LED DIM 1x8W (E27)
Lamp not included

IP20  

+  Dimmer

Energy Label n°30 (A++ → E)

**Objective**

p. 84

LED Total power 11W
Color temperature 3000K
CRI 80

Spot light
Lighting output 270lm
Diffused light
Lighting output 275lm



IP20  

+  Dimmer

Energy Label n°1 (A++ → A)

Onfale piccolo

p. 130

HALO 1x46W (E14)
or LED 1x6W (E14)
Lamp not included

IP20  

Energy Label n°30 (A++ → E)

**Onfale medio**

p. 130

HALO 1x46W (E27)
or LED 1x6W (E27)
+ HALO 1x20W (E14)
or LED 1x2W (E14)
Lamp not included

IP20  

Energy Label n°30 (A++ → E)

**Onfale grande**

p. 130

HALO 1x77W (E27)
or LED 1x8W (E27)
+ HALO 1x20W (E14)
or LED 1x2W (E14)
Lamp not included

IP20  

Energy Label n°30 (A++ → E)

**Sisifo**

p. 88

LED Total power 13,5W
Color temperature 3000K
Lighting output 646lm
CRI 80

IP20  

+  Dimmer

Energy Label n°1 (A++ → A)

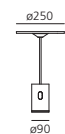
**Talak professional**

p. 74

LED Total power 13W
Color temperature 3000K
Lighting output 1100lm
CRI 90

IP20  

+  Dimmer

Energy Label n°1 (A++ → A)

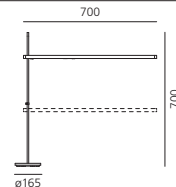

Tizio LED

p. 66

LED Total power 8W
 Color temperature 3000K
 Lighting output 393lm
 CRI 80

IP20

+ - Dimmer

Energy Label n°1 (A++ → A)

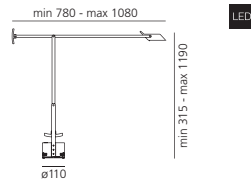

LED

Tizio

p. 66

HALO 1x50W/12V (GY6,35)
 or LED 1x2,5W (GY6,35)
 Lamp not included
 With two light levels

IP20

Energy Label n°30 (A++ → E)

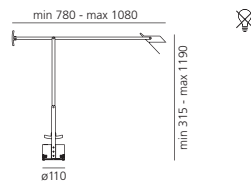
**Tizio 35**

p. 66

HALO 1x35W/12V (GY6,35)
 or LED 1x2,5W (GY6,35)
 Lamp not included
 With two light levels

IP20

Energy Label n°30 (A++ → E)

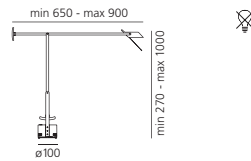
**Tizio micro**

p. 66

HALO 1x20W/12V (G4)
 or LED 1x2,4W (G4)
 Lamp not included

IP20

Energy Label n°30 (A++ → E)

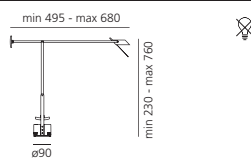
**Tolomeo**

p. 44

Tolomeo LED/LED MD

LED Total power 10W
 Color temperature 3000K
 Lighting output 480lm
 CRI 80

IP20

+ - Dimmer

Energy Label n°1 (A++ → A)

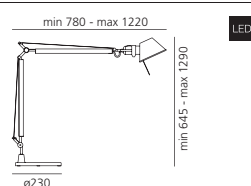

LED

Tolomeo LED TW

LED Total power 14W
 Warm/Cold white 2300K/10000K
 (amber, white, blue)
 Lighting output 450lm
 CRI 80

IP20

+ - Dimmer

Energy Label n°1 (A++ → A)

LED

Tolomeo Halo

HALO 1x77W (E27)
 or LED 1x8W (E27)
 Lamp not included

IP20

Energy Label n°30 (A++ → E)

Tolomeo mini

p. 44

Tolomeo mini LED/LED MD

LED Total power 10W
 Color temperature 3000K
 Lighting output 480lm
 CRI 80

IP20

+ - Dimmer

Energy Label n°1 (A++ → A)

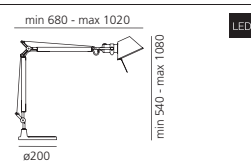

LED

Tolomeo mini Halo

HALO 1x77W (E27)
 or LED 1x8W (E27)
 Lamp not included

IP20

Energy Label n°30 (A++ → E)

Tolomeo midi LED

p. 44

LED Total power 9W
 Color temperature 3000K
 Lighting output 365lm
 CRI 80

IP20

+ - Dimmer

Energy Label n°1 (A++ → A)

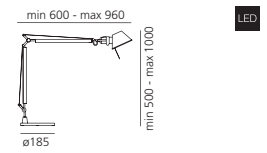

LED

Tolomeo micro

p. 44

Tolomeo micro LED

LED Total power 8W
 Color temperature 3000K
 Lighting output 365lm
 CRI 80

IP20

+ - Dimmer

Energy Label n°1 (A++ → A)

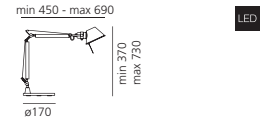

LED

Tolomeo micro Halo

HALO 1x46W (E14)
 or LED 1x4W (E14)
 Lamp not included

IP20

Energy Label n°30 (A++ → E)

Tolomeo basculante

p. 60

HALO 1x46W (E27)
 or LED 1x8W (E27)
 Lamp not included

IP20

Energy Label n°30 (A++ → E)

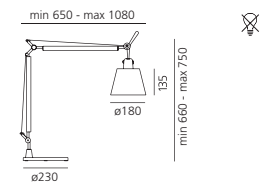
**Tolomeo Mega**

p. 62

Tolomeo Mega LED

LED Total power 31W
 Color temperature 3000K
 CRI 92

Lighting output
 natural diffuser 1999lm-2016lm
 grey diffuser 1894lm-1914lm
 black diffuser 1681m-1693lm

IP20

+ - Dimmer

Energy Label n°1 (A++ → A)

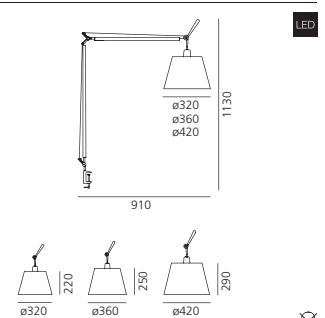

LED

Tolomeo Mega Halo table

HALO 1x150W (E27)
 or LED max 1x8W (E27)

IP20

+ - Dimmer / On-Off Switch

Energy Label n°30 (A++ → E)

Unterlinden table

p. 64

LED Total power 7,5W
 Color temperature 2700K/3000K
 Lighting output 359lm/359lm
 CRI 90

IP20

+ - Dimmer

Energy Label n°1 (A++ → A)

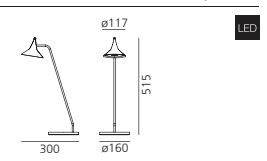

LED

Lampade da terra

Floor lamps
Lampadaires
Stehleuchten
Lámparas de pie

Athena

p. 142

LED Total power 44W
Color temperature 2700K / 3000K
Lighting output 3265lm / 3492lm
CRI 90

IP20  EAC

+  - Dimmer

Energy Label n°1 (A++ → A)



LED

Cabildo LED floor

p. 174

LED Total power 45W
Color temperature 2700K / 3000K
Lighting output 2641lm / 2824lm
CRI 90

IP20  EAC

+  - Dimmer

Energy Label n°1 (A++ → A)

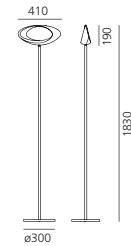

LED

Cadmo Floor

p. 150

Cadmo LED Floor

Indirect emission:
LED Total power 44W
Color temperature 2700K / 3000K
Lighting output 3831lm / 4003lm
CRI 90

+  - Dimmer

Direct emission:
LED 1x10W (GU10) 2700K / 3000K
Lamp included
Not dimmable

IP20  EAC

Energy Label n°17 (A++ → A)



LED



Cadmo Halo floor

Indirect emission:
HALO 1x230W (R7s)
or LED DIM 1x11W (R7s) - Lamp not included

Direct emission:
LED reflector 1x20W (E27) - Lamp not included

IP20  EAC 

+  - Dimmer

Energy Label n°30 (A++ → E)





Castore 35 floor

p. 188

HALO 1x150W (E27)
or LED DIM 1x21W (E27)
Lamp not included

IP20  EAC 

+  - Dimmer

Energy Label n°30 (A++ → E)

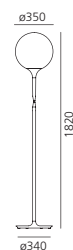



Choose floor

p. 194

HALO 2x57W (E27)
or LED 2x8W (E27)
Lamp not included

IP20  EAC

Energy Label n°30 (A++ → E)

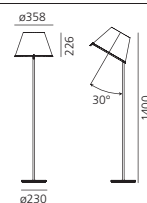



Choose mega floor

p. 194

Direct emission:
HALO 3x77W (E27)
or LED 3x10W (E27)
Lamp not included

Indirect emission:
HALO reflector 1x100W (E27)
or LED 1x8W (E27)
Lamp not included

IP20  EAC

Energy Label n°30 (A++ → E)

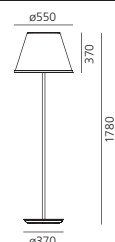





Cosmic Leaf

p. 176

HALO 1x100W (G53)
or LED 1x8,5W (G53)
Lamp not included

IP20 **ERC**

Energy Label n°30 (A++ → E)

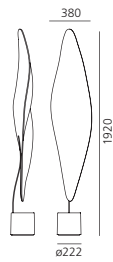

Decomposé light floor

p. 158

LED Total power 45W
Color temperature 3000K
Lighting output 3564lm
CRI 90

IP20 **ERC**

+ - Dimmer

Energy Label n°1 (A++ → A)

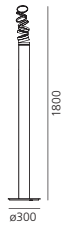

Demetra reading floor

p. 168

Demetra reading floor

LED Total power 8W
Color temperature 2700K / 3000K
Lighting output 360lm / 385lm
CRI 90

IP20 **ERC**

+ - Dimmer

Energy Label n°1 (A++ → A)

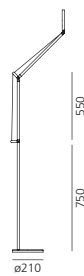

Demetra reading floor MD

LED Total power 8W
Color temperature 3000K
Lighting output 385lm
CRI 90

IP20 **ERC**

+ - Dimmer

Energy Label n°1 (A++ → A)



Demetra professional reading floor

p. 168

LED Total power 12W
Color temperature 3000K
Lighting output 960lm
CRI 90

IP20 **ERC**

+ - Dimmer

Energy Label n°1 (A++ → A)

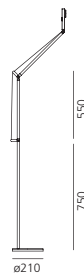

Empatia 26 floor

p. 184

LED Total power 20W
Color temperature 3000K
Lighting output 709lm
CRI 90

IP20 **ERC**

+ - Dimmer

Energy Label n°1 (A++ → A)

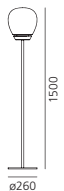

Fiamma reading floor

p. 164

LED 1x8W (GU10)
Lamp not included

IP20 **ERC**

Energy Label n°9 (A+ → A)

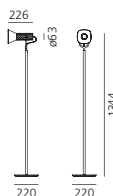

Fiamma 15

p. 166

LED Total power 14W
Color temperature 3000K
Lighting output 1321lm
CRI 90

IP20 **ERC**

+ - Dimmer

Energy Label n°1 (A++ → A)



Ilio

p. 138

LED Total power 45W
Color temperature 2700K / 3000K
Lighting output 3332lm / 3564lm
CRI 90

IP20 **ERC**

+ - Dimmer

Energy Label n°1 (A++ → A)

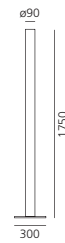

La Petite floor

p. 190

LED 1x12W (E27)
Lamp not included

IP20 **ERC**

Energy Label n°2 (A++ → A)



Megaron LED

p. 156

LED Total power 45W
Color temperature 2700K / 3000K
Lighting output 3814lm / 4079lm
CRI 90

+ - Dimmer

IP20 **ERC**

Energy Label n°1 (A++ → A)



Melampo floor

p. 192

HALO 2x57W (E27)
or LED 1x8W (E27)
Lamp not included

IP20 **ERC**

Energy Label n°30 (A++ → E)

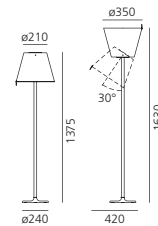

Melampo mega floor

p. 192

HALO 1x150W (E27)
or LED DIM 1x21W (E27)
Lamp not included

IP20 **ERC**

+ - Dimmer

Energy Label n°30 (A++ → A)

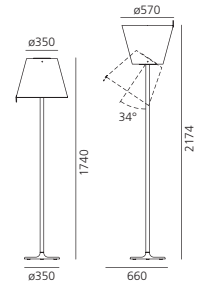

Meteorite 35 floor

p. 186

HALO 1x150W (E27)
or LED DIM 1x8W (E27)
Lamp not included

IP20 **ERC**

+ - Dimmer

Energy Label n°30 (A++ → A)

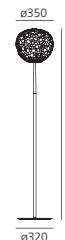

Mimesi

p. 154

Indirect emission:

LED Total power 42W
Color temperature 3000K
Lighting output 3733lm
CRI 90

Diffused emission:

LED Total power 3W
Color temperature 6000K
Lighting output 100lm
CRI 80

IP20 

+  Dimmer

Energy Label n°1 (A++ → A)



LED

LED

Talak professional reading floor

p. 172

LED Total power 13W
Color temperature 3000K
Lighting output 1100lm
CRI 90

IP20   ERAC

+  Dimmer

Energy Label n°1 (A++ → A)

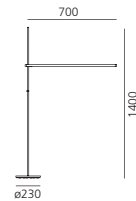

LED

New Nature

p. 146

Indirect emission:

LED Total power 43W
Color temperature 2700K / 3000K
Lighting output 3132m / 3350lm
CRI 90

Direct emission:

LED Total power 10W
Color temperature 3000K
Lighting output 260lm
CRI 80

IP20 

+  Dimmer

Energy Label n°1 (A++ → A)



LED

LED

Tizio 35 floor support

p. 170

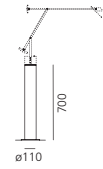

ø110

Tizio 35 floor support

p. 170

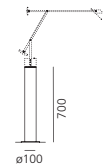

ø100

Reall

p. 160

LED Total power 45W
Color temperature 3000K
Lighting output 2631lm
CRI 80

IP20 

+  Dimmer

Energy Label n°1 (A++ → A)

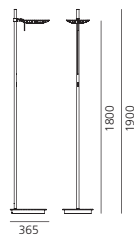

LED

Tolomeo floor

p. 196

Tolomeo LED floor

LED Total power 10W
Color temperature 3000K
Lighting output 480lm
CRI 80

IP20   ERAC 

+  Dimmer

Energy Label n°1 (A++ → A)

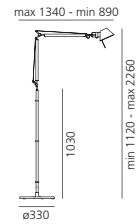

ø330

Tolomeo LED TW floor

LED Total power 14W
Color temperature 2300K / 10000K
(amber, white, blue)
Lighting output 450lm
CRI 80

IP20   ERAC 

+  Dimmer

Energy Label n°1 (A++ → A)

LED

LED

Reeds

p. 182

LED Total power 9,5W
Color temperature 3000K
Lighting output 79lm
CRI 80

IP20 

Energy Label n°1 (A++ → A)



LED

Tolomeo Halo floor

HALO 1x77W (E27)
or LED 1x8W (E27)
Lamp not included

IP20   ERAC 

Energy Label n°30 (A++ → E)



Solium

p. 152

LED Total power 37W
Color temperature 3000K
Lighting output 945lm
CRI 80

IP20 

+  Dimmer

Energy Label n°1 (A++ → A)

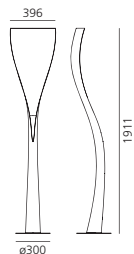

LED

Tolomeo basculante floor

p. 198

HALO 1x46W (E27)
or LED 1x8W (E27)
Lamp not included

IP20   ERAC 

Energy Label n°30 (A++ → E)

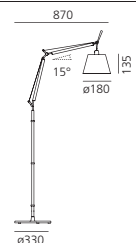

ø330



Tolomeo basculante reading floor

p. 198

HALO 1x46W (E27)
or LED 1x8W (E27)
Lamp not included

IP20

Energy Label n°30 (A++ → E)



Tolomeo micro floor

p. 196

Tolomeo micro LED floor

LED Total power 8W
Color temperature 3000K
Lighting output 365lm
CRI 80

IP20

+ - Dimmer

Energy Label n°1 (A++ → A)



Tolomeo mega

p. 200

Tolomeo mega LED

LED Total power 31W
Color temperature 3000K
CRI 92

Lighting output
natural diffuser 1999lm-2016lm
grey diffuser 1894lm-1914lm
black diffuser 1681lm-1693lm

IP20

+ - Dimmer

Energy Label n°1 (A++ → A)

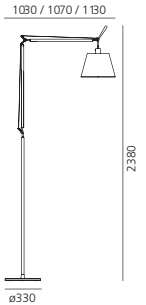

Tolomeo mega Halo

HALO 1x150W (E27)
or LED 1x8W (E27)
Lamp not included

IP20

+ - Dimmer / On-Off Switch

Energy Label n°30 (A++ → E)

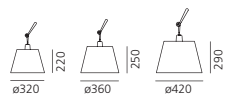

Tolomeo reading floor

p. 196

Tolomeo LED reading floor

LED Total power 10W
Color temperature 3000K
Lighting output 480lm
CRI 80

IP20

+ - Dimmer

Energy Label n°1 (A++ → A)

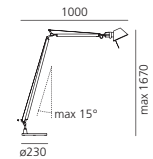

Tolomeo Halo reading floor

HALO 1x77W (E27)
or LED 1x8W (E27)
Lamp not included

IP20

Energy Label n°30 (A++ → E)



Tolomeo lampione outdoor

p. 202

LED Total power 20W
Color temperature 3000K
Lighting output 1613lm
CRI 80

IP44

Energy Label n°1 (A++ → A)

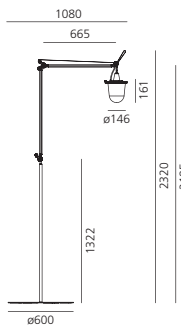

Tolomeo XXL

p. 208

Indoor version
FLUO 2x57W (GX24q-5)
Lamp included

IP65

Energy Label n°28 (A)

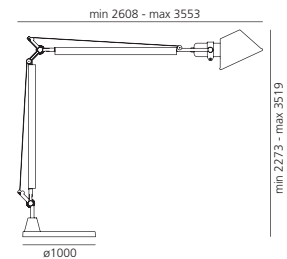

Tolomeo paralume outdoor

p. 202

LED Total power 20W
Color temperature 3000K
Lighting output 815lm
CRI 80

IP44

Energy Label n°1 (A++ → A)

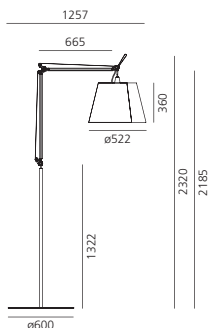

Trix floor

p. 178

LED Total power 23W
Color temperature 3000K
Lighting output 1965lm
CRI 90

IP20

+ - Dimmer

Energy Label n°1 (A++ → A)

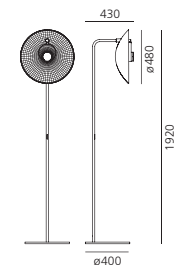

Vigo reading floor

p. 180

LED 1x6,8W (GU10)
Lamp not included

IP20

Energy Label n°9 (A+ → A)

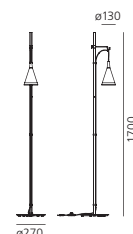

Lampade a sospensione

Suspension lamps
Suspensions
Pendelleuchten
Suspensiones

Alphabet of light circular 90

p. 228

LED Total power 70W
Color temperature 3000K
Lighting output 7000lm
CRI 80

IP20  EAC

+  Dimmable (Push)

Energy Label n°1 (A++ → A)

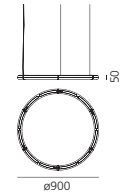

LED

Alphabet of light circular 155

p. 228

LED Total power 130W
Color temperature 3000K
Lighting output 13000lm
CRI 80

IP20  EAC

+  Dimmable (Push)

Energy Label n°1 (A++ → A)

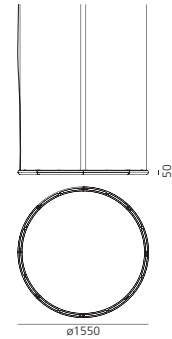

LED

Alphabet of light linear 120

p. 228

LED Total power 30W
Color temperature 3000K
Lighting output 3000lm
CRI 80

IP20  EAC

+  Dimmable (Push)

Energy Label n°1 (A++ → A)

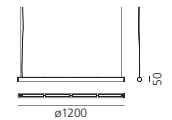

LED

Alphabet of light linear 180

p. 228

LED Total power 45W
Color temperature 3000K
Lighting output 4500lm
CRI 80

IP20  EAC

+  Dimmable (Push)

Energy Label n°1 (A++ → A)

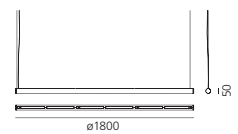

LED

Altrove LED suspension

p. 278

Altrove LED suspension Direct

LED Total power 80W
Color temperature RGB
Lighting output 1250lm

IP20  EAC

+  Dimmer

Energy Label n°1 (A++ → A)

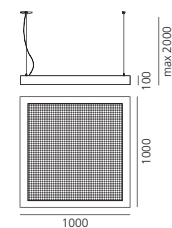

LED

Altrove LED suspension Direct/Indirect

LED Total power 80W
Color temperature RGB
Lighting output 1500lm

IP20  EAC

+  Dimmer

Energy Label n°1 (A++ → A)

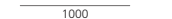

LED

Altrove 600 LED suspension

p. 282

Altrove 600 LED suspension Direct

LED Total power 28W
Color temperature 3000K
Lighting output 2000lm
CRI 90

IP20  EAC

+  Dimmable (Push)

Energy Label n°1 (A++ → A)

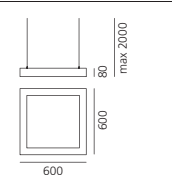

LED

Altrove 600 LED suspension Direct/Indirect

LED Total power 28W
Color temperature 3000K
Lighting output 2330lm
CRI 90

IP20  EAC

+  Dimmable (Push)

Energy Label n°1 (A++ → A)



LED

Ameluna

p. 216

LED Total power 41W
Color temperature 3000K
Lighting output 3276lm
CRI 90

IP20

+ Dimmable (push)

Energy Label n°1 (A++ → A)

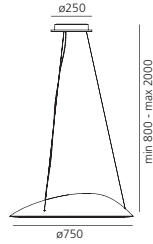

LED

Castore 35 suspension

p. 342

HALO 1x150W (E27)
or LED DIM 1x21W (E27)
Lamp not included

IP20

+ Dimmable

Energy Label n°30 (A++ → E)



LED

Castore 42 suspension

p. 342

HALO 1x150W (E27)
or LED DIM 1x21W (E27)
Lamp not included

IP20

+ Dimmable

Energy Label n°30 (A++ → E)

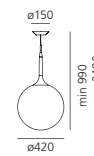

LED

Ameluna RGB

p. 216

LED Total power 45W
Color temperature RGB
Lighting output 3414lm
CRI 90

IP20

+ Dimmable (push) and Ameluna APP

Energy Label n°1 (A++ → A)

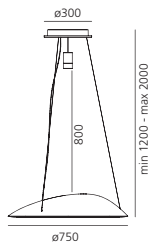

LED

Castore calice 18

p. 344

HALO 1x48W (G9)
or LED DIM 1x2,3W (G9)
Lamp not included

IP20

+ Dimmable

Energy Label n°30 (A++ → E)

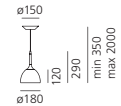

LED

Cabildo LED suspension

p. 316

LED Total power 44W
Color temperature 2700K / 3000K
Lighting output 2641lm / 2824lm
CRI 90

IP20

+ Dimmable (push)

Energy Label n°1 (A++ → A)

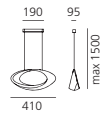

LED

Chlorophilia

p. 212

LED Total power 44W
Color temperature 3000K
Lighting output 3146lm
CRI 90

IP20

+ Dimmable (push)

Energy Label n°1 (A++ → A)

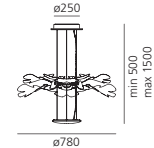

LED

Calenda

p. 362

FLUO 4x55W (2G11)
Lamp included

+ Dimmable (push)

+ LED 3,5W blue

IP65

Energy Label n°54 (A++ → A)

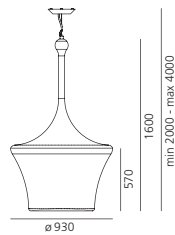

LED

Chlorophilia 2

p. 214

LED Total power 44W
Color temperature 3000K
Lighting output 3146lm
CRI 90

IP20

+ Dimmable (push)

Energy Label n°1 (A++ → A)

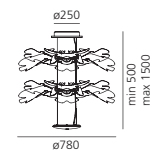

LED

Castore 14 suspension

p. 342

HALO 1x48W (G9)
or LED DIM 1x2,3W (G9)
Lamp not included

IP20

+ Dimmable

Energy Label n°30 (A++ → E)



LED

Choose suspension

p. 372

HALO 1x77W (E27)
or LED DIM 1x10W (E27)
Lamp not included

IP20

+ Dimmable

Energy Label n°30 (A++ → E)

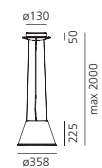

LED

Castore 25 suspension

p. 342

HALO 1x77W (E27)
or LED DIM 1x10W (E27)
Lamp not included

IP20

+ Dimmable

Energy Label n°30 (A++ → E)

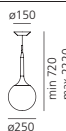

LED

Choose mega suspension

p. 372

HALO 3x77W (E27)
or LED DIM 3x10W (E27)
Lamp not included

IP20

+ Dimmable

Energy Label n°30 (A++ → E)

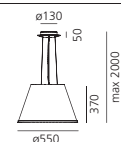

LED

Copernico

p. 258

LED Total power 38W
Color temperature 3000K
Lighting output 2565lm

IP20  

+  - Dimmable (push)

Energy Label n°1 (A++ → A)

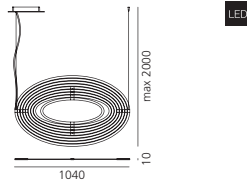

Copernico 500

p. 262

LED Total power 27W
Color temperature 3000K
Lighting output 2375lm

IP20  

+  - Dimmable (push)

Energy Label n°1 (A++ → A)

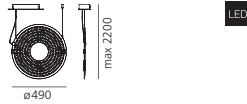

Cosmic Angel

p. 298

HALO 2x400W (R7s)
or LED DIM 2x11W (R7s)
Lamp not included

IP20  

+  - Dimmable

Energy Label n°30 (A++ → E)

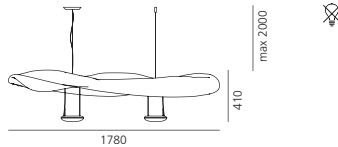

Decomposé light suspension

p. 306

LED 1x6W (E27)
or FLUO 1x8W (E27)
Lamp not included

IP20  

Energy Label n°2 (A++ → A)



Discovery

p. 234

LED Total power 46W
Color temperature 3000K
Lighting output 2475lm
CRI 90

IP20  

+  - Dimmable (push)

Energy Label n°1 (A++ → A)

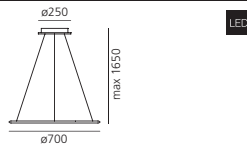

Eclicitta 20

p. 304

LED Total power 13,5W
Color temperature 3000K
Lighting output 1205lm
CRI 80

IP20  

+  - Dimmable (push)

Energy Label n°1 (A++ → A)

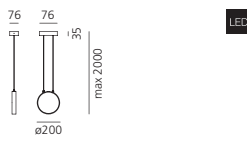

Eclicitta 50

p. 300

Direct Emission
LED Total power 8,5W
Color temperature 3000K
Lighting output 809lm
CRI 80

Indirect Emission
LED Total power 17W
Color temperature 3000K
Lighting output 1724lm
CRI 80

IP20  

+  - Dimmable (push)

Energy Label n°1 (A++ → A)

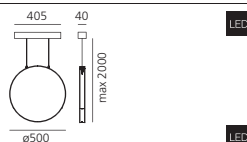

Edge 30

p. 370

FLUO 1x23W (E27)
or LED DIM 1x8W (E27)
Lamp not included

IP20  

+  - Dimmable

Energy Label n°2 (A++ → A)

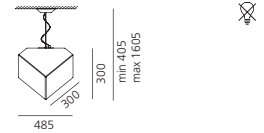

Eggboard Matrix 1600x800

p. 374

Eggboard Matrix 1600x800 Direct

LED Total power 31W
Color temperature 3000K / 4000K
Lighting output 2626lm / 2626lm
CRI 80

IP20  

+  - Dimmable

Energy Label n°1 (A++ → A)

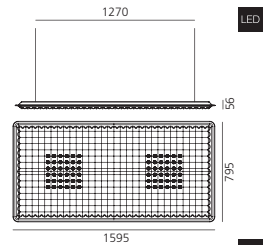

Eggboard Matrix 1600x800 Direct + Indirect

Direct emission
LED Total power 31W
Color temperature 3000K / 4000K
Lighting output 2626lm / 2626lm
CRI 80

Indirect emission
LED Total power 44W
Color temperature 3000K / 4000K
Lighting output 4030lm / 4234lm
CRI 80

IP20  

+  - Dimmable

Energy Label n°1 (A++ → A)

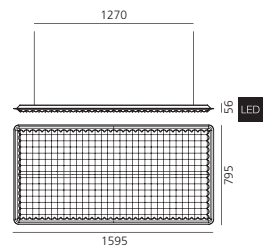

(without LED)

Eggboard Matrix 800x800

p. 374

Eggboard Matrix 800x800 Direct

LED Total power 16W
Color temperature 3000K / 4000K
Lighting output 1313lm / 1313lm
CRI 80

IP20  

+  - Dimmable

Energy Label n°1 (A++ → A)

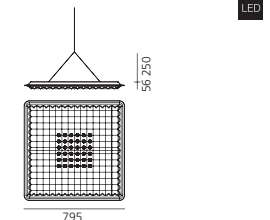

Eggboard Matrix 800x800 Direct + Indirect

Direct emission
LED Total power 16W
Color temperature 3000K / 4000K
Lighting output 1313lm / 1313lm
CRI 80

Indirect emission
LED Total power 23W
Color temperature 3000K / 4000K
Lighting output 2015lm / 2117lm
CRI 80

IP20  

+  - Dimmable

Energy Label n°1 (A++ → A)

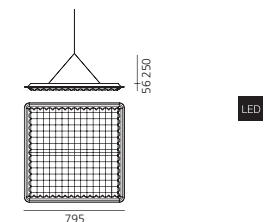

(without LED)

Empatia 16 suspension

p. 338

LED Total power 11W
Color temperature 3000K
Lighting output 567lm
CRI 90

IP20  

Energy Label n°1 (A++ → A)



Empatia 26 suspension

p. 338

LED Total power 16W
Color temperature 3000K
Lighting output 709lm
CRI 90

IP20  EAC

+  Dimmable (Push)

Energy Label n°1 (A++ → A)



Incalmo 214

p. 332

LED Total power 29W
Color temperature 3000K
Lighting output 2020lm
CRI 90

IP20  EAC

+  Dimmable (Push)

Energy Label n°1 (A++ → A)

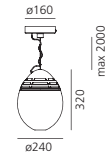

Empatia 36 suspension

p. 338

LED Total power 24W
Color temperature 3000K
Lighting output 1273lm
CRI 90

IP20  EAC

+  Dimmable (Push)

Energy Label n°1 (A++ → A)

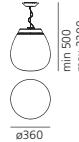

Invero

p. 336

LED Total power 44W
Color temperature 3000K
Lighting output 2472lm
CRI 90

IP20  EAC

+  Dimmable (Push)

Energy Label n°1 (A++ → A)

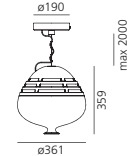

Empririco

p. 360

Empririco
FLUO 2x35W (G5)
Lamp included

IP20  EAC

+  Dimmable

Energy Label n°23 (A+ → A)

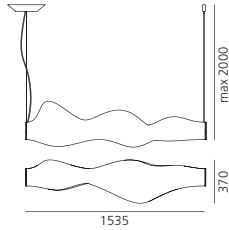

Empririco system

FLUO 2x35W (G5)
Lamp included

IP20  EAC

+  Dimmable

Energy Label n°23 (A+ → A)

Invero 214

p. 336

LED Total power 29W
Color temperature 3000K
Lighting output 1946lm
CRI 90

IP20  EAC

+  Dimmable (Push)

Energy Label n°1 (A++ → A)

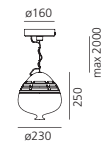

Lana

p. 368

LED DIM 1x6,8W (GU10)
Lamp not included

IP20  EAC

+  Dimmable

Energy Label n°9 (A+ → A)

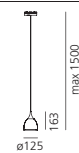

Fiamma suspension

p. 272

LED DIM 1x8W (GU10)
Lamp not included

IP20  EAC

+  Dimmable

Energy Label n°9 (A+ → A)

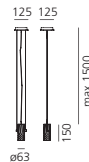

Led Net circle suspension

p. 270

LED Total power 43W
Color temperature 3000K
Lighting output 2502lm
CRI 80

IP20  EAC

+  Dimmable (Push)

Energy Label n°1 (A++ → A)

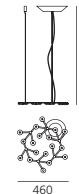

Fiamma 30

p. 274

LED Total power 28W
Color temperature 3000K
Lighting output 1878lm
CRI 90

IP20  EAC

+  Dimmable (Push)

Energy Label n°1 (A++ → A)

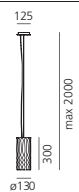

Led Net Line 125 suspension

p. 266

LED Total power 45W
Color temperature 3000K
Lighting output 2530lm
CRI 80

IP20  EAC

+  Dimmable (Push)

Energy Label n°1 (A++ → A)

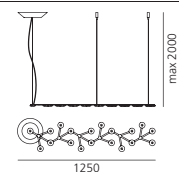

Float circolare

p. 312

FLUO 1x55W (2GX13)
Lamp included

IP20  EAC

Energy Label n°28 (A)



Led Net Line 66 suspension

p. 266

LED Total power 23W
Color temperature 3000K
Lighting output 1265lm
CRI 80

IP20  EAC

Energy Label n°1 (A++ → A)

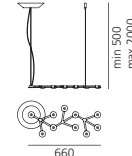

Incalmo

p. 332

LED Total power 44W
Color temperature 3000K
Lighting output 2945lm
CRI 90

IP20  EAC

+  Dimmable (Push)

Energy Label n°1 (A++ → A)

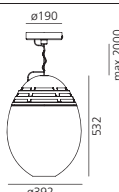

Les Danseuses

p. 384

LED Total power 30W
Color temperature 3000K
Lighting output 1980lm
CRI 80

IP20  EAC

+  Dimmer

Energy Label n°1 (A++ → A)

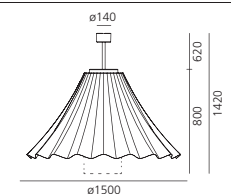

Logico

p. 356

HALO 1x116W (E27)
or LED DIM 1x15W (E27)
Lamp not included

IP20    

+  - Dimmable

Energy Label n°30 (A++ → E)

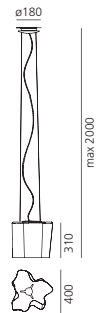

Logico suspension 3x120°

p. 356

HALO 3x116W (E27)
or LED DIM 3x15W (E27)
Lamp not included

IP20    

+  - Dimmable

Energy Label n°30 (A++ → E)

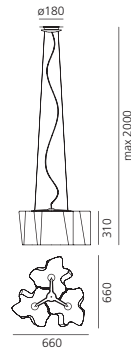

Logico suspension 3 in linea

p. 356

HALO 3x116W (E27)
or LED DIM 3x15W (E27)
Lamp not included

IP20    

+  - Dimmable

Energy Label n°30 (A++ → E)

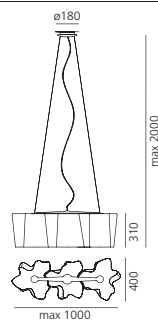

Logico mini suspension

p. 356

HALO 1x77W (E27)
or LED DIM 1x10W (E27)
Lamp not included

IP20    

+  - Dimmable

Energy Label n°30 (A++ → E)

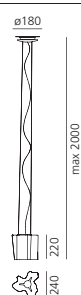

Logico mini suspension 3x120°

p. 356

HALO 3x77W (E27)
or LED DIM 3x10W (E27)
Lamp not included

IP20    

+  - Dimmable

Energy Label n°30 (A++ → E)

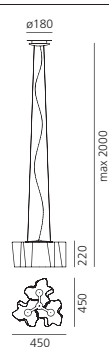

Logico mini suspension 3 in linea

p. 356

HALO 3x77W (E27)
or LED DIM 3x10W (E27)
Lamp not included

IP20    

+  - Dimmable

Energy Label n°30 (A++ → E)

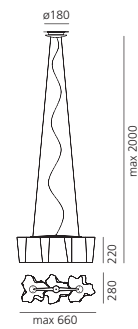

Mercury

p. 296

Mercury LED

LED Total power 2x29W
Color temperature 2700K / 3000K
Lighting output 2893lm / 3094lm
CRI 90

IP20   

+  - Dimmable (Push)

Energy Label n°1 (A++ → A)

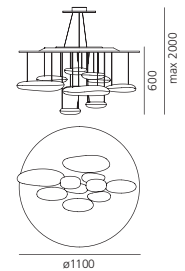

Mercury Halo

HALO 2x160W (R7s)
or LED DIM 2x11W (R7s)
Lamp not included

IP20   

+  - Dimmable

Energy Label n°30 (A++ → E)



Mercury mini

p. 296

Mercury mini LED

LED Total power 29W
Color temperature 2700K / 3000K
Lighting output 1447lm / 1547lm
CRI 90

IP20   

+  - Dimmable (Push)

Energy Label n°1 (A++ → A)

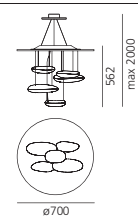

Mercury mini Halo

HALO 1x160W (R7s)
or LED DIM 1x11W (R7s)
Lamp not included

IP20   

+  - Dimmable

Energy Label n°30 (A++ → E)



Meteorite 15 suspension

p. 340

HALO 1x48W (G9)
or LED DIM 1x2,3W (G9)
Lamp not included

IP20   

+  - Dimmable

Energy Label n°30 (A++ → E)



Meteorite 35 suspension

p. 340

HALO 1x150W (E27)
or LED DIM 1x8W (E27)
Lamp not included

IP20 **ERC**

+ Dimmable

Energy Label n°30 (A++ → E)

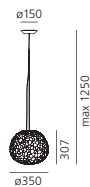

Meteorite 48 suspension

p. 340

HALO 1x150W (E27)
or LED DIM 1x8W (E27)
Lamp not included

IP20 **ERC**

+ Dimmable

Energy Label n°30 (A++ → E)

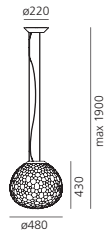

Miconos

p. 354

FLUO 1x23W (E27)
or LED DIM 1x15W (E27) globe Ø 12cm
Lamp not included

IP20 **ERC**

+ Dimmable

Energy Label n°2 (A++ → A)



Miyako 30

p. 308

LED Total power 6W
Color temperature 3000K
Lighting output 180lm
CRI 85

IP20 **ERC**

Energy Label n°1 (A++ → A)



Miyako 55

p. 308

LED Total power 6W
Color temperature 3000K
Lighting output 180lm
CRI 85

IP20 **ERC**

Energy Label n°1 (A++ → A)

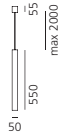

Miyako Chandelier

p. 308

LED Total power 6x6W/4x6W
Color temperature 3000K
Lighting output 6x180lm/4x180lm
CRI 85

IP20 **ERC**

Energy Label n°1 (A++ → A)

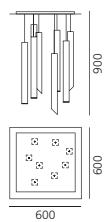

Mouette simmetrica

p. 366

Mouette simmetrica LED

LED Total power 55W
Color temperature 3000K
Lighting output 6221lm
CRI 80

IP20 **ERC**

+ Dimmable (Dali)

Energy Label n°1 (A++ → A)

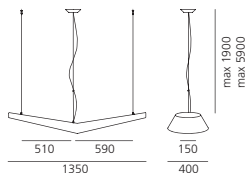

Mouette simmetrica

FLUO 4x24W (G5), 3000K
Lamp included

IP20 **ERC**

+ Dimmable

Energy Label n°54 (A++ → A)



Mouette asimmetrica

p. 366

Mouette asimmetrica LED

LED Total power 80W
Color temperature 3000K
Lighting output 10368lm
CRI 80

IP20 **ERC**

+ Dimmable (Dali)

Energy Label n°1 (A++ → A)

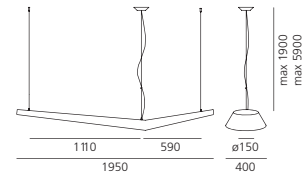

Mouette asimmetrica

FLUO 2x24W (G5), 3000K
+
FLUO 2x54W (G5), 3000K
Lamps included

+ Dimmable

IP20 **ERC**

Energy Label n°54 (A++ → A)



Nuboli

p. 364

FLUO 6x55W (2G11)
Lamp included

IP20 **ERC**

+ Dimmable

Energy Label n°33 (A+ → A)

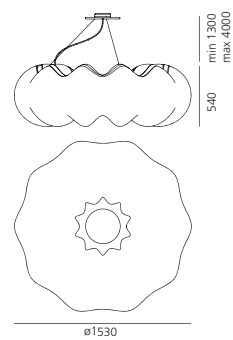

Miyako 30

p. 308

LED Total power 6W
Color temperature 3000K
Lighting output 180lm
CRI 85

IP20 **ERC**

Energy Label n°1 (A++ → A)



Null vector α

p. 276

LED DIM 1x6W (E14)
Lamp not included

IP20 **ERC**

+ Dimmable

Energy Label n°2 (A++ → A)

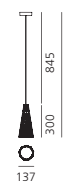

Null vector β

p. 276

LED DIM 1x6W (E14)
Lamp not included

IP20 **ERC**

+ Dimmable

Energy Label n°2 (A++ → A)



Nur

p. 288

Nur LED

LED Total power 45W
Color temperature 2700K
Lighting output 1882lm
CRI 90

IP20 **ERC**

+ Dimmable (Push)

Energy Label n°1 (A++ → A)

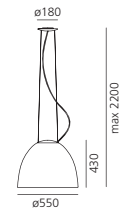

Nur Halo

HALO 1x205W (E27)
or LED DIM 1x21W (E27)
Lamp not included

IP20 **ERC**

+ Dimmable

Energy Label n°30 (A++ → E)



Nur 1618

p. 288

Nur 1618 LED

LED Total power 95W
Color temperature 3000K
Lighting output 4556lm
CRI 90

IP20

+ - Dimmable (Push)

Energy Label n°1 (A++ → A)

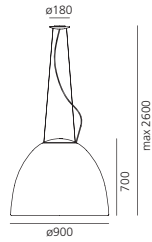

LED

Nur 1618 Halo

HALO 2x400W (R7s)
or LED DIM 2x11W (R7s)
Lamp not included

IP20

+ - Dimmable

Energy Label n°30 (A++ → E)



Nur Gloss

p. 294

Nur Gloss LED

LED Total power 45W
Color temperature 2700K
Lighting output 1882lm
CRI 90

IP20

+ - Dimmable (Push)

Energy Label n°1 (A++ → A)

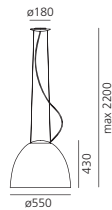

LED

Nur Gloss Halo

HALO 1x205W (E27)
or LED DIM 1x21W (E27)
Lamp not included

IP20

+ - Dimmable

Energy Label n°30 (A++ → E)



Nur mini

p. 288

Nur mini LED

LED Total power 30W
Color temperature 2700K
Lighting output 1501lm
CRI 90

IP20

+ - Dimmable (Push)

Energy Label n°1 (A++ → A)

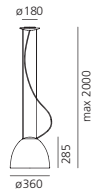

LED

Nur mini Halo

HALO 1x160W (R7s)
or LED DIM 1x11W (R7s)
Lamp not included

IP20

+ - Dimmable

Energy Label n°30 (A++ → E)



Nur Gloss mini

p. 294

Nur Gloss mini LED

LED Total power 30W
Color temperature 2700K
Lighting output 1501lm
CRI 90

IP20

+ - Dimmable (Push)

Energy Label n°1 (A++ → A)

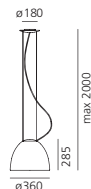

LED

Nur Gloss mini Halo

HALO 1x150W (E27)
or LED DIM 1x21W (E27)
Lamp not included

IP20 IP40

+ - Dimmable

Energy Label n°30 (A++ → E)



Nur Acoustic

p. 382

LED Total power 95W
Color temperature 3000K
Lighting output 5367lm
CRI 90

IP20

+ - Dimmable (Push)

Energy Label n°1 (A++ → A)

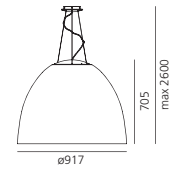

LED

Orsa 21

p. 242

LED Total power 7W
Color temperature 3000K
Lighting output 500lm
CRI 90

IP20

Energy Label n°1 (A++ → A)

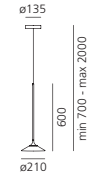

LED

Orsa 35

p. 242

LED Total power 20W
Color temperature 3000K
Lighting output 1800lm
CRI 90

IP20

+ - Dimmable (Push)

Energy Label n°1 (A++ → A)

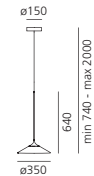

LED

Orsa Chandelier 3

p. 244

LED Total power 21W
Color temperature 3000K
Lighting output 1500lm
CRI 90

IP20

+ - Dimmable (Push)

Energy Label n°1 (A++ → A)

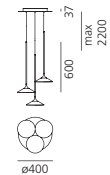

LED

Orsa Chandelier 5

p. 244

LED Total power 35W
Color temperature 3000K
Lighting output 2500lm
CRI 90

IP20

+ - Dimmable (Push)

Energy Label n°1 (A++ → A)

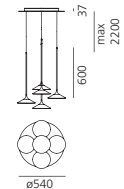

LED

Pirce

p. 250

Pirce LED

LED Total power 44W
Color temperature 2700K / 3000K
Lighting output 3097lm / 3313lm
CRI 90

IP20

+ - Dimmable (Push)

Energy Label n°1 (A++ → A)

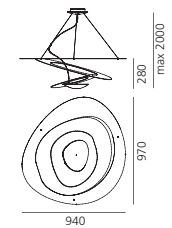

LED

Pirce Halo

HALO 1x330W (R7s)
or LED DIM 1x11W (R7s)
Lamp not included

IP20

+ - Dimmable

Energy Label n°30 (A++ → E)



Pirce micro LED

p. 250

LED Total power 27W
Color temperature 2700K / 3000K
Lighting output 2573lm / 2753lm
CRI 90

IP20

+ - Dimmable (Push)

Energy Label n°1 (A++ → A)



LED

Pirce mini

p. 250

Pirce mini LED

LED Total power 44W
Color temperature 2700K / 3000K
Lighting output 3097lm / 3313lm
CRI 90

IP20 EAC

+ Dimmable (Push)

Energy Label n°1 (A++ → A)

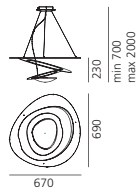

LED

Pirce mini Halo

HALO 1x330W (R7s)
or LED DIM 1x11W (R7s)
Lamp not included

IP20 EAC

+ Dimmable

Energy Label n°30 (A++ → E)



Scopas

p. 256

LED Total power 80W
Color temperature 3000K
Lighting output 3440lm
CRI 80

IP20 EAC

+ Dimmable (Push)

Energy Label n°1 (A++ → A)

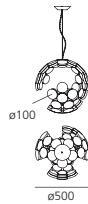

LED

Silent Field

p. 378

LED Total power 25W
Color temperature 3000K
Lighting output 1800lm
CRI 90

IP20 EAC

+ Dimmable (Push)

Energy Label n°1 (A++ → A)

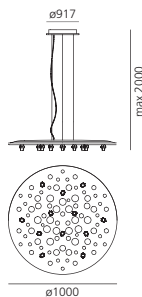

LED

Space Cloud

p. 254

LED Total power 43W
Color temperature 3000K
Lighting output 1444lm
CRI 90

IP20 EAC

+ Dimmable (Push)

Energy Label n°1 (A++ → A)

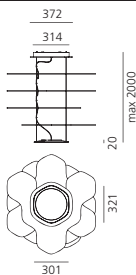

LED

Spectral Light

p. 238

Direct Light
LED Total power 12x1,8W
Color temperature RGB

Indirect Light
LED Total power 45W
Color temperature 3000K
Lighting output 3250lm
CRI 90

IP20 EAC

+ Dimmable (Push)

Energy Label n°1 (A++ → A)

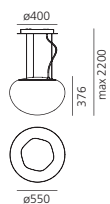

LED

LED

LED

LED

Stabligh

p. 348

PAR LED DIM 3x6,8W 36° (GU10)
Lamp not included

IP20 EAC

+ Dimmable

Energy Label n°9 (A+ → A)

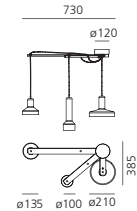

LED

Stabligh A, B, C

p. 348

PAR LED DIM 1x6,8W 36° (GU10)
Lamp not included

IP20 EAC

+ Dimmable

Energy Label n°9 (A+ → A)

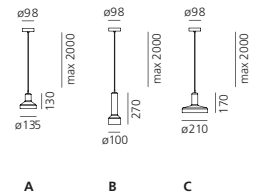

LED

Talo 90 LED suspension

p. 314

LED Total power 32W
Color temperature 3000K
Lighting output 3216lm
CRI 80

IP20 EAC

+ Dimmable (Push) and Not Dimmable

Energy Label n°1 (A++ → A)

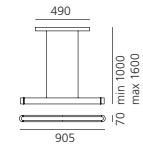

LED

Talo120 LED suspension

p. 314

LED Total power 51W
Color temperature 3000K
Lighting output 4518lm
CRI 80

IP20 EAC

+ Dimmable (Push) and Not Dimmable

Energy Label n°1 (A++ → A)

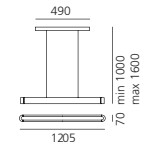

LED

Talo150 LED suspension

p. 314

LED Total power 60W
Color temperature 3000K
Lighting output 5837lm
CRI 80

IP20 EAC

+ Dimmable (Push) and Not Dimmable

Energy Label n°1 (A++ → A)

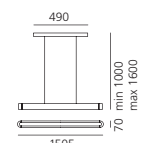

LED

Tian Xia 500 LED

p. 284

Direct emission
LED Total power 42W
Color temperature 3000K
Lighting output 2000lm
CRI 90

Indirect emission
LED Total power 37W
Color temperature 3000K
Lighting output 2500lm
CRI 90

Diffused emission
LED Total power 35W (RGB)

IP20 EAC

+ Dimmer

Energy Label n°1 (A++ → A)

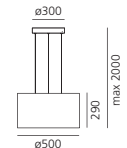

LED

LED

LED

LED

Tolomeo due bracci aluminum suspension

p. 318

HALO 2x77W (E27)
or LED 2x8W (E27)
Lamp not included

IP20

Energy Label n°30 (A++ → E)

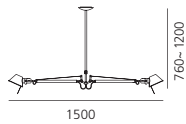

Unterlinden

p. 246

LED Total power 7,5W
Color temperature 2700K / 3000K
Lighting output 359lm / 359lm
CRI 90

IP20

Energy Label n°1 (A++ → A)

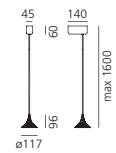

Tolomeo due bracci pergamena suspension

p. 320

HALO 2x150W (E27)
or LED DIM 2x8W (E27)
Lamp not included

IP20

+ - Dimmable

Energy Label n°30 (A++ → E)

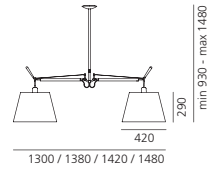

Tolomeo decentrata suspension Aluminum diffuser

p. 322

HALO 1x77W (E27)
or LED DIM 1x8W (E27)
Lamp not included

IP20

+ - Dimmable

Energy Label n°30 (A++ → E)

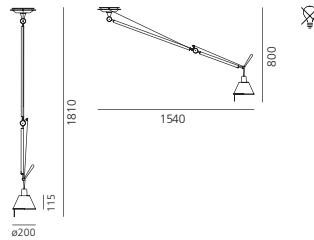

Vigo suspension

p. 346

LED DIM 1x6,8W (GU10)
Lamp not included

IP20

+ - Dimmable

Energy Label n°9 (A+ → A)



Tolomeo decentrata suspension Parchment paper/silk satin fabric diffuser

p. 322

Ø 240
HALO 1x77W (E27)
or LED DIM 1x8W (E27)
Lamp not included

Ø 320, 360
HALO 1x150W (E27)
or LED DIM 1x21W (E27)
Lamp not included

IP20

+ - Dimmable

Energy Label n°30 (A++ → E)

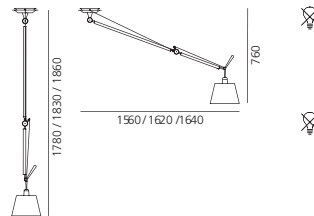

Tolomeo mega suspension

p. 326

HALO 1x150W (E27)
or LED DIM 1x21W (E27)
Lamp not included

IP20

+ - Dimmable

Energy Label n°30 (A++ → E)

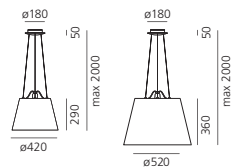

Lampade da parete/soffitto

Wall/Ceiling lamps
Appliques/Plafonniers
Wandleuchten/Deckenleuchten
Apliques/Pláfonos

Alphabet of light

p. 392

LED Total power 9W - 38W
Color temperature 3000K
Lighting output 500lm - 1850lm

IP20  

+  Dimmable (Push)

Energy Label n°1 (A++ → A)

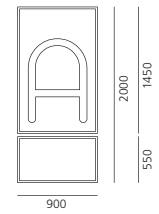

LED

Altrove LED

p. 496

Direct light
LED Total power 80W
Color temperature RGB
Lighting output 1250lm

IP20  

+  Dimmer

Energy Label n°1 (A++ → A)

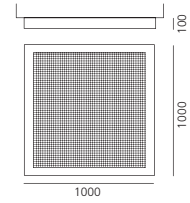

LED

Altrove 600 LED

p. 498

LED Total power 28W
Color temperature 3000K
Lighting output 2000lm
CRI 90

IP20  

+  Dimmable (Push)

Energy Label n°1 (A++ → A)

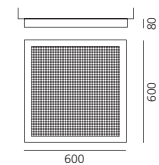

LED

Botanic Rain

p. 540

Only for custom projects
which feasibility must be approved
by Artemide Technical Design
Department

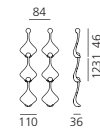

LED

Cabildo LED wall

p. 434

LED Total power 28W
Color temperature 2700K / 3000K
Lighting output 1996lm / 2137lm
CRI 90

IP20  

+  Dimmable (Push)

Energy Label n°1 (A++ → A)

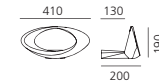

LED

Cadmo LED wall

p. 436

LED DIM 2x10W (GU10)
Lamp included

IP20  

+  Dimmable

Energy Label n°36 (A++ → A)

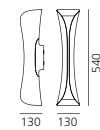

LED

Choose Wall

p. 440

HALO 1x46W (E14)
or LED DIM 1x6W (E14)
Lamp not included

IP23  

+  Dimmable

Energy Label n°30 (A++ → E)



LED

Cosmic Angel ceiling

p. 536

HALO 2x400W (R7s)
or LED DIM 2x11W (R7s)
Lamp not included
+
FLUO 2x55W (2G11)
Lamp included

IP20  

+  Dimmable

Energy Label n°62 (A++ → E)

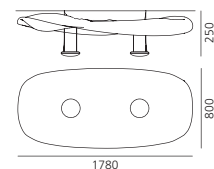

LED

Crazy

p. 494

LED Total power 35W
 Color temperature 3000K
 Lighting output 3310lm
 CRI 80

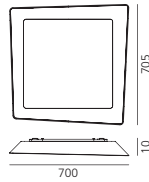

IP20

+ - Dimmable (1-10V)

Energy Label n°1 (A++ → A)

Cuma 10

p. 426

LED Total power 14W
 Color temperature 3000K
 Lighting output 730lm
 CRI 90



IP20

Energy Label n°1 (A++ → A)

Cuma 20

p. 426

LED Total power 28W
 Color temperature 3000K
 Lighting output 1570lm
 CRI 80

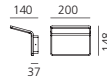

IP20

+ - Dimmable (Push)

Energy Label n°1 (A++ → A)

Decomposé light ceiling

p. 504

FLUO 1x8W (E27)
 or LED 1x6W (E27)
 Lamp not included

IP20

Energy Label n°2 (A++ → A)

**Demetra faretto**

p. 448

Demetra faretto (with switch)

LED Total power 9W
 Color temperature 2700K / 3000K
 Lighting output 360lm / 385lm
 CRI 90

IP20

+ - Dimmer

Energy Label n°1 (A++ → A)

**Demetra faretto (without switch)**

LED Total power 8W
 Color temperature 2700K / 3000K
 Lighting output 360lm / 385lm
 CRI 90

IP20

Energy Label n°1 (A++ → A)

**Demetra wall, Demetra MD wall**

p. 450

LED Total power 8W
 Color temperature 2700K / 3000K
 Lighting output 360lm / 385lm
 CRI 90

IP20

+ - Dimmer

Energy Label n°1 (A++ → A)

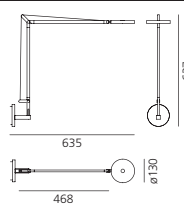
**Demetra professional wall**

p. 450

LED Total power 12W
 Color temperature 3000K
 Lighting output 960lm
 CRI 90

IP20

+ - Dimmer

Energy Label n°1 (A++ → A)

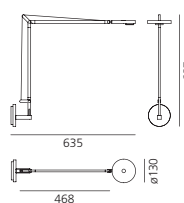
**Demetra micro wall**

p. 450

LED Total power 6W
 Color temperature 2700K / 3000K
 Lighting output 241m / 257lm
 CRI 90

IP20

+ - Dimmer

Energy Label n°1 (A++ → A)

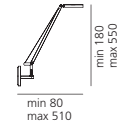
**Dinarco**

p. 432

HALO 1x160W (R7s)
 or LED DIM 1x11W ((R7s)
 Lamp not included

IP20

+ - Dimmable

Energy Label n°30 (A++ → E)

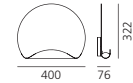
**Dioscuri 14 wall/ceiling**

p. 490

HALO 1x48W (G9)
 or LED DIM 1x2.3W (G9)
 Lamp not included

IP65

+ - Dimmable

Energy Label n°30 (A++ → E)

**Dioscuri 25 wall/ceiling**

p. 490

HALO 1x77W (E27)
 or LED DIM 1x8W (E27)
 Lamp not included

IP65

+ - Dimmable

Energy Label n°30 (A++ → E)

**Dioscuri 35 wall/ceiling**

p. 490

HALO 1x150W (E27)
 or LED DIM 1x8W (E27)
 Lamp not included

IP65

+ - Dimmable

Energy Label n°30 (A++ → E)

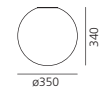
**Dioscuri 42 wall/ceiling**

p. 490

HALO 1x150W (E27)
 or LED DIM 1x8W (E27)
 Lamp not included

IP65

+ - Dimmable

Energy Label n°30 (A++ → E)

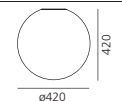
**Discovery wall/ceiling**

p. 400

LED Total power 46W
 Color temperature 3000K
 Lighting output 2475lm
 CRI 90

IP20

+ - Dimmable (Push)

Energy Label n°1 (A++ → A)

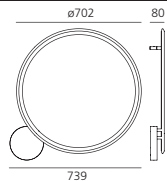

Droplet

p. 534

Droplet LED

LED Total power 3x29W
Color temperature 2700K / 3000K
Lighting output 3031lm / 3241lm
CRI 90

IP20   EAC

+  - Dimmable (Push)

Energy Label n°1 (A++ → A)

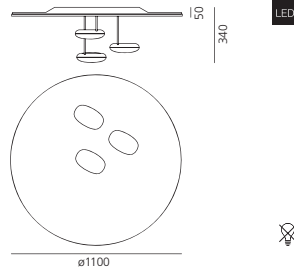

Droplet Halo

HALO 3x160W (R7s)
or LED DIM 3x11W (R7s)
Lamp not included

IP20   EAC

+  - Dimmable

Energy Label n°30 (A++ → E)

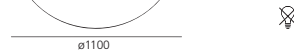

Droplet mini

p. 474

Droplet mini LED

LED Total power 29W
Color temperature 2700K / 3000K
Lighting output 1168lm / 1249lm
CRI 90

IP20   EAC

+  - Dimmable (Push)

Energy Label n°1 (A++ → A)

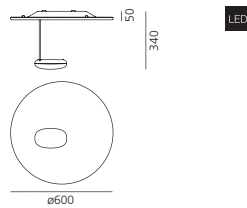

Droplet mini Halo

HALO 1x160W (R7s)
or LED DIM 1x11W (R7s)
Lamp not included

IP20   EAC

+  - Dimmable

Energy Label n°30 (A++ → E)



Eclettica 20 wall/ceiling

p. 478

LED Total power 13,5W
Color temperature 3000K
Lighting output 1205lm
CRI 80

IP20   EAC

+  - Dimmable (Push)

Energy Label n°1 (A++ → A)

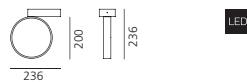

Edge 21 wall/ceiling

p. 500

FLUO 1x20W (E27)
or LED DIM 1x8W (E27)
Lamp not included

IP65   EAC

+  - Dimmable

Energy Label n°2 (A++ → A)

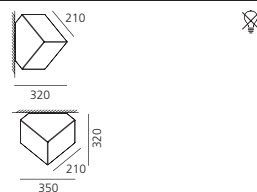

Edge 30 wall/ceiling

p. 500

FLUO 1x23W (E27)
or LED DIM 1x8W (E27)
Lamp not included

IP65   EAC

+  - Dimmable

Energy Label n°2 (A++ → A)

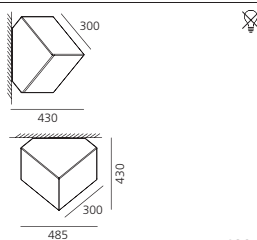

Empatia 16 wall/ceiling

p. 482

LED Total power 11W
Color temperature 3000K
Lighting output 567lm
CRI 90

IP20   EAC

Energy Label n°1 (A++ → A)



Empatia 26 wall/ceiling

p. 482

LED Total power 16W
Color temperature 3000K
Lighting output 709lm
CRI 90

IP20   EAC

+  - Dimmable (Push)

Energy Label n°1 (A++ → A)



Empatia 36 wall/ceiling

p. 482

LED Total power 24W
Color temperature 3000K
Lighting output 1273lm
CRI 90

IP20   EAC

+  - Dimmable (Push)

Energy Label n°1 (A++ → A)



Febe

p. 468

LED Total power 31W
Color temperature 2700K / 3000K
Lighting output 1830lm / 1900lm
CRI 90

IP20   EAC

+  - Dimmable (Push)

Energy Label n°1 (A++ → A)

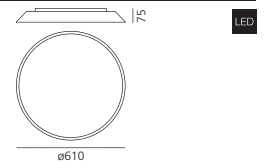

Fiamma wall/ceiling

p. 476

LED DIM 1x8W (GU10)
Lamp not included

IP20   EAC

+  - Dimmable

Energy Label n°9 (A+ → A)

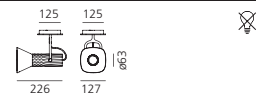

Fiamma 15 ceiling

p. 506

LED Total power 20W
Color temperature 3000K
Lighting output 1620lm
CRI 90

IP20   EAC

+  - Dimmable (Push)

Energy Label n°1 (A++ → A)



Fiamma 30 ceiling

p. 506

LED Total power 28W
Color temperature 3000K
Lighting output 1878lm
CRI 90

IP20   EAC

+  - Dimmable (Push)

Energy Label n°1 (A++ → A)



Flashit

p. 406

LED Total power 31W
Color temperature 3000K
Lighting output 2212lm
CRI 80

IP20   EAC

+  - Dimmer

Energy Label n°1 (A++ → A)

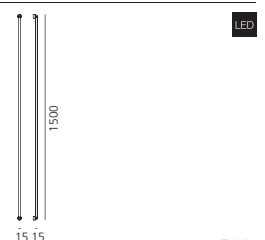

Float circolare ceiling

p. 514

FLUO 1x55W (2GX13)
Lamp included

IP20   EAC 

Energy Label n°28 (A)

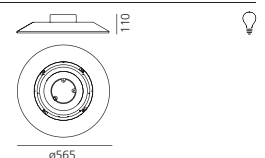

Groupage 20

p. 512

LED Total power 13W
 Color temperature 3000K
 Lighting output 491lm
 CRI 80



IP20 EAC

+ - Dimmable (Push)

Energy Label n°1 (A++ → A)

Groupage 32

p. 512

LED Total power 23W
 Color temperature 3000K
 Lighting output 1451lm
 CRI 80

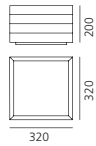

IP20 EAC

+ - Dimmable (Push)

Energy Label n°1 (A++ → A)

Groupage 45

p. 512

LED Total power 40W
 Color temperature 3000K
 Lighting output 3036lm
 CRI 80

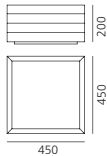

IP20 EAC

+ - Dimmable (Push)

Energy Label n°1 (A++ → A)

Incalmo ceiling

p. 524

LED Total power 44W
 Color temperature 3000K
 Lighting output 2945lm
 CRI 90

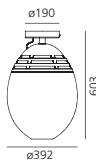

IP20 EAC

+ - Dimmable (Push)

Energy Label n°1 (A++ → A)

Incalmo 214 ceiling

p. 524

LED Total power 29W
 Color temperature 3000K
 Lighting output 2020lm
 CRI 90



IP20 EAC

+ - Dimmable (Push)

Energy Label n°1 (A++ → A)

Invero ceiling

p. 522

LED Total power 44W
 Color temperature 3000K
 Lighting output 2472lm
 CRI 90

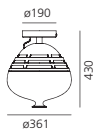

IP20 EAC

+ - Dimmable (Push)

Energy Label n°1 (A++ → A)

Invero 214 ceiling

p. 522

LED Total power 29W
 Color temperature 3000K
 Lighting output 1946lm
 CRI 90



IP20 EAC

+ - Dimmable (Push)

Energy Label n°1 (A++ → A)

losif

p. 508

LED Total power 4,5W
 Color temperature 3000K
 Lighting output 207lm
 CRI 93



IP20 EAC

Energy Label n°1 (A++ → A)

Islet

p. 418

LED Total power 16W
 Color temperature 3000K
 Lighting output 1174lm
 CRI 90



IP20 EAC

+ - Dimmable (Push)

Energy Label n°1 (A++ → A)

La Petite wall

p. 442

LED DIM 1x6W (E14)
 Lamp not included

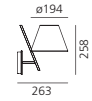

IP20 EAC

+ - Dimmable

Energy Label n°2 (A++ → A)

Led Net circle

p. 520

LED Total power 43W
 Color temperature 3000K
 Lighting output 2502lm
 CRI 80

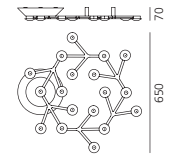

IP20 EAC

+ - Dimmable (Push)

Energy Label n°1 (A++ → A)

Led Net line 125

p. 518

LED Total power 45W
 Color temperature 3000K
 Lighting output 2530lm
 CRI 80

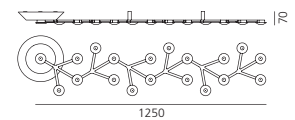

IP20 EAC

+ - Dimmable (Push)

Energy Label n°1 (A++ → A)

Led Net line 66

p. 518

LED Total power 23W
 Color temperature 3000K
 Lighting output 1265lm
 CRI 80

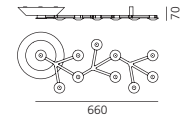

IP20 EAC

Energy Label n°1 (A++ → A)

Logico ceiling

p. 526

HALO 1x116W (E27)
 or LED DIM 1x15W (E27)
 Lamp not included

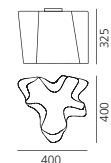

IP20 EAC

+ - Dimmable

Energy Label n°30 (A++ → E)

Logico ceiling 3x120°

p. 526

HALO 3x116W (E27)
 or LED DIM 3x15W (E27)
 Lamp not included

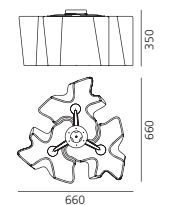

IP20 EAC

+ - Dimmable

Energy Label n°30 (A++ → E)

Logico micro ceiling

p. 526

HALO 1x46W (E14)
 or LED DIM 1x6W (E14)
 Lamp not included



IP20 EAC

+ - Dimmable

Energy Label n°30 (A++ → E)

Logico micro ceiling 3x120°

p. 526

HALO 3x46W (E14)
or LED DIM 3x6W (E14)
Lamp not included

IP20

+ - Dimmable

Energy Label n°30 (A++ → E)

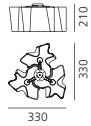

Logico mini ceiling

p. 526

HALO 1x77W (E27)
or LED DIM 1x10W (E27)
Lamp not included

IP20

+ - Dimmable

Energy Label n°30 (A++ → E)

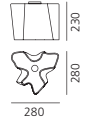

Logico mini ceiling 3x120°

p. 526

HALO 3x77W (E27)
or LED DIM 3x10W (E27)
Lamp not included

IP20

+ - Dimmable

Energy Label n°30 (A++ → E)

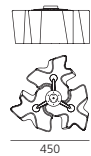

Logico wall

p. 444

HALO 2x57W (E27)
or LED DIM 2x8W (E27)
Lamp not included

IP20

+ - Dimmable

Energy Label n°30 (A++ → E)

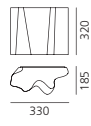

Logico micro wall

p. 444

HALO 1x46W (E14)
or LED DIM 1x6W (E14)
Lamp not included

IP20

+ - Dimmable

Energy Label n°30 (A++ → E)



Logico mini wall

p. 444

HALO 1x57W (E27)
or LED DIM 1x8W (E27)
Lamp not included

IP20

+ - Dimmable

Energy Label n°30 (A++ → E)

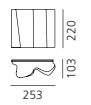

Melampo Wall

p. 438

HALO 1x46W (E14)
or LED DIM 1x6W (E14)
Lamp not included

IP20

+ - Dimmable

Energy Label n°30 (A++ → E)

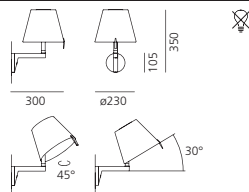

Melete

p. 430

Melete LED

LED Total power 27W
Color temperature 2700K / 3000K
Lighting output 2047lm / 2191lm
CRI 90

IP20

+ - Dimmable (Push)

Energy Label n°1 (A++ → A)

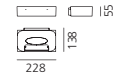

Melete Halo

HALO 1x160W (R7s)
or LED DIM 1x11W (R7s)
Lamp not included

IP20

+ - Dimmable

Energy Label n°30 (A++ → E)



Mercury ceiling

p. 538

Mercury LED ceiling

LED Total power 2x29W
Color temperature 2700K / 3000K
Lighting output 2893lm / 3094lm
CRI 90

IP20

+ - Dimmable (Push)

Energy Label n°1 (A++ → A)

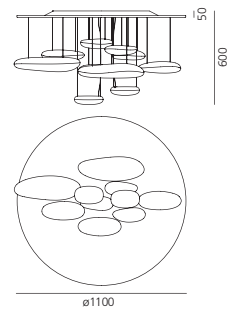

Mercury ceiling Halo

HALO 2x160W (R7s)
or LED DIM 2x11W (R7s)
Lamp not included

IP20

+ - Dimmable

Energy Label n°30 (A++ → E)



Mercury mini ceiling

p. 538

Mercury mini LED ceiling

LED Total power 29W
Color temperature 2700K / 3000K
Lighting output 1447lm / 1547lm
CRI 90

IP20

+ - Dimmable (Push)

Energy Label n°1 (A++ → A)

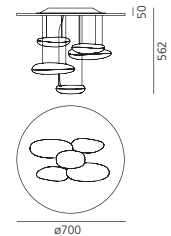

Mercury mini Halo ceiling

HALO 1x160W (R7s)
or LED DIM 1x11W (R7s)
Lamp not included

IP20

+ - Dimmable

Energy Label n°30 (A++ → E)



Mesmary

p. 408

Mesmary LED

LED Total power 28W
Color temperature 2700K / 3000K
Lighting output 2450lm / 2622lm
CRI 90

IP20

+ - Dimmable (Push)

Energy Label n°1 (A++ → A)

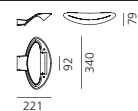

Mesmary Halo

HALO 1x230W (R7s)
or LED DIM 1x11W (R7s)
Lamp not included

IP20

+ - Dimmable

Energy Label n°30 (A++ → E)



Meteorite 15 wall/ceiling

p. 486

Meteorite 15 mini LED wall/ceiling

LED Total power 8W
 Color temperature 3000K
 Lighting output 285lm
 CRI 90



IP20 EAC

Energy Label n°1 (A++ → A)

Meteorite 15 wall/ceiling

HALO 1x48W (G9)
 or LED DIM 1x2,3W (G9)
 Lamp not included

IP20 EAC

+ - Dimmable

Energy Label n°30 (A++ → E)

Meteorite 35 wall/ceiling

p. 486

HALO 1x150W (E27)
 or LED DIM 1x8W (E27)
 Lamp not included

IP20 EAC

+ - Dimmable

Energy Label n°30 (A++ → E)

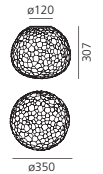
**Meteorite 48 ceiling**

p. 486

HALO 1x150W (E27)
 or LED DIM 1x8W (E27)
 Lamp not included

IP20 EAC

+ - Dimmable

Energy Label n°30 (A++ → E)

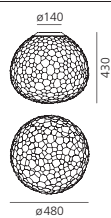
**Miconos ceiling**

p. 492

FLUO 1x23W (E27)
 or LED DIM 1x15W (E27) globe ø 12cm
 Lamp not included

IP20 EAC

+ - Dimmable

Energy Label n°2 (A++ → A)

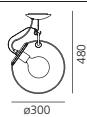
**Miconos wall**

p. 492

FLUO 1x20W (E27)
 or LED DIM 1x12W (E27) globe ø 9cm
 Lamp not included

IP20 EAC

+ - Dimmable

Energy Label n°2 (A++ → A)

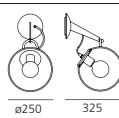
**Microsurf**

p. 422

LED Total power 20W
 Color temperature 3000K
 Lighting output 1942lm
 CRI 80

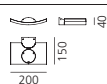

IP20 EAC

Energy Label n°1 (A++ → A)

Miyako 30 wall

p. 502

LED Total power 10W
 Color temperature 3000K
 Lighting output 2x180lm
 CRI 85



IP20 EAC

Energy Label n°1 (A++ → A)

Miyako 30 ceiling

p. 502

LED Total power 6W
 Color temperature 3000K
 Lighting output 180lm
 CRI 85



IP20 EAC

Energy Label n°1 (A++ → A)

Nebula

p. 472

LED Total power 50W
 Color temperature 3000K
 Lighting output 2062lm

IP20 EAC

Energy Label n°1 (A++ → A)

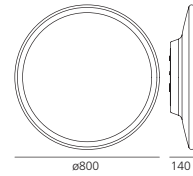
**Nur mini ceiling**

p. 528

Nur mini LED ceiling

LED Total power 30W
 Color temperature 2700K
 Lighting output 1501lm
 CRI 90

IP20 EAC

+ - Dimmable (Push)

Energy Label n°1 (A++ → A)

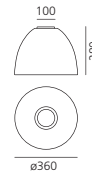
**Nur mini Halo ceiling**

HALO 1x150W (E27)
 or LED DIM 1x21W (E27)
 Lamp not included

IP20 EAC

+ - Dimmable

Energy Label n°30 (A++ → E)

Nur mini gloss ceiling

p. 530

Nur mini gloss LED ceiling

LED Total power 30W
 Color temperature 2700K
 Lighting output 1501lm
 CRI 90

IP20 EAC

+ - Dimmable (Push)

Energy Label n°1 (A++ → A)

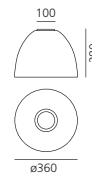
**Nur mini gloss Halo ceiling**

HALO 1x150W (E27)
 or LED DIM 1x21W (E27)
 Lamp not included

IP20 EAC

+ - Dimmable

Energy Label n°30 (A++ → E)

Orbiter ceiling

p. 480

LED Total power 20W
 Color temperature 3000K
 Lighting output 1493lm
 CRI 90

IP20 EAC

+ - Dimmable (Push)

Energy Label n°1 (A++ → A)

**Orbiter wall**

p. 480

LED Total power 20W
 Color temperature 3000K
 Lighting output 1585lm
 CRI 90

IP20 EAC

+ - Dimmable (Push)

Energy Label n°1 (A++ → A)

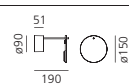

Pirce ceiling

p. 516

Pirce LED ceiling

LED Total power 44W
Color temperature 2700K / 3000K
Lighting output 3097lm / 3313lm
CRI 90

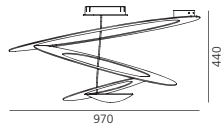

IP20 **ERC**

+ - Dimmable (Push)

Energy Label n°1 (A++ → A)

Pirce Halo ceiling

HALO 1x330W (R7s)
or LED DIM 1x11W (R7s)
Lamp not included

IP20 **ERC**

+ - Dimmable

Energy Label n°30 (A++ → E)



Pirce mini ceiling

p. 516

Pirce mini LED ceiling

LED Total power 44W
Color temperature 2700K / 3000K
Lighting output 3097lm / 3313lm
CRI 90

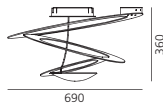

IP20 **ERC**

+ - Dimmable (Push)

Energy Label n°1 (A++ → A)

Pirce mini Halo ceiling

HALO 1x330W (R7s)
or LED DIM 1x11W (R7s)
Lamp not included

IP20 **ERC**

+ - Dimmable

Energy Label n°30 (A++ → E)



Pirce wall

p. 420

HALO 1x230W (R7s)
or LED DIM 1x11W (R7s)
Lamp not included

IP20 **ERC**

+ - Dimmable

Energy Label n°30 (A++ → E)

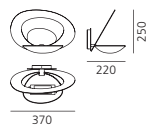

Pirce micro LED wall

p. 420

LED Total power 27W
Color temperature 2700K / 3000K
Lighting output 2586lm / 2768lm
CRI 90

IP20 **ERC**

+ - Dimmable (Push)

Energy Label n°1 (A++ → A)



Rea 12

p. 424

LED Total power 9W
Color temperature 3000K
Lighting output 790lm
CRI 80

IP20 **ERC**

Energy Label n°1 (A++ → A)



Rea 17

p. 424

LED Total power 20W
Color temperature 3000K
Lighting output 1950lm
CRI 80

IP20 **ERC**

Energy Label n°1 (A++ → A)

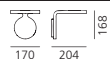

Skydro

p. 532

Skydro LED

LED Total power 29W
Color temperature 2700K / 3000K
Lighting output 1554lm / 1662lm
CRI 90

IP20 **ERC**

+ - Dimmable (Push)

Energy Label n°1 (A++ → A)

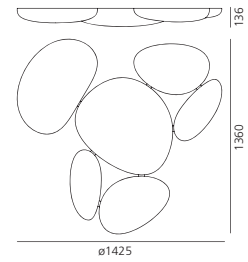

Skydro Halo

HALO 1x160W (R7s)
or LED DIM 1x11W (R7s)
Lamp not included

IP20 **ERC**

+ - Dimmable

Energy Label n°30 (A++ → E)

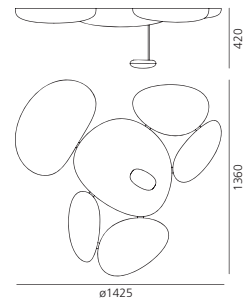

Talak Professional wall

p. 454

LED Total power 13W
Color temperature 3000K
Lighting output 1100lm
CRI 90

IP20 **ERC**

+ - Dimmer

Energy Label n°1 (A++ → A)

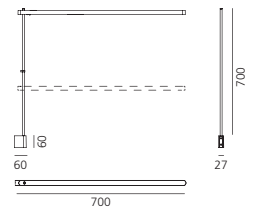

Talo LED

p. 414

LED Total power 20W
Color temperature 2700K / 3000K
Lighting output 1343lm / 1343lm
CRI 90

IP20 **ERC**

+ - Dimmable (Push)

Energy Label n°1 (A++ → A)



Talo Halo

p. 414

HALO 1x120W (R7s)
or LED DIM 1x11W (R7s)
Lamp not included

IP20 **ERC**

+ - Dimmable

Energy Label n°30 (A++ → E)



Talo 60 LED

p. 416

LED Total power 25W
Color temperature 3000K
Lighting output 2473lm
CRI 80

IP20 **ERC**

Energy Label n°1 (A++ → A)

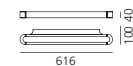

Talo 90 LED

p. 416

LED Total power 32W
Color temperature 3000K
Lighting output 3216lm
CRI 80

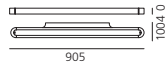

IP20 **ERC**

+ - Dimmable (Push) and Not Dimmable

Energy Label n°1 (A++ → A)

Talo 120 LED

p. 416

LED Total power 51W
Color temperature 3000K
Lighting output 4518lm
CRI 80

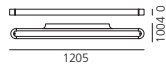

IP20 **ERC**

+ - Dimmable (Push) and Not Dimmable

Energy Label n°1 (A++ → A)

Talo 150 LED

p. 416

LED Total power 60W
Color temperature 3000K
Lighting output 5837lm
CRI 80

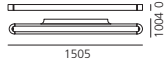

IP20 **ERC**

+ - Dimmable (Push) and Not Dimmable

Energy Label n°1 (A++ → A)

Teti

p. 446

HALO 1x30W (E27)
or LED DIM 1x6W (E27)
Lamp not included



IP20 **ERC**

+ - Dimmable

Energy Label n°30 (A++ → E)

Tigia

p. 428

LED Total power 14W
Color temperature 3000K
Lighting output 1144lm
CRI 90



IP20 **ERC**

+ - Dimmable (Push)

Energy Label n°1 (A++ → A)

Tolomeo braccio

p. 456

Tolomeo braccio LED

LED Total power 10W
Color temperature 3000K
Lighting output 480lm
CRI 80

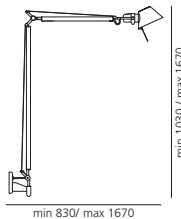

IP20 **ERC**

+ - Dimmer

Energy Label n°1 (A++ → A)

Tolomeo braccio Halo

HALO 1x77W (E27)
or LED 1x8W (E27)
Lamp not included

IP20 **ERC**

Energy Label n°30 (A++ → E)

Tolomeo wall

p. 456

Tolomeo LED wall

LED Total power 10W
Color temperature 3000K
Lighting output 480lm
CRI 80

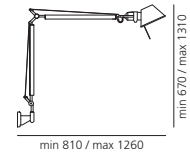

IP20 **ERC**

+ - Dimmer

Energy Label n°1 (A++ → A)

Tolomeo LED TW wall

LED Total power 14W
Warm/Cold white 2300K/10000K
amber, white, blue
Lighting output 450lm
CRI 80



IP20 **ERC**

+ - Dimmer

Energy Label n°1 (A++ → A)

Tolomeo Halo wall

HALO 1x77W (E27)
or LED 1x8W (E27)
Lamp not included



IP20 **ERC**

Energy Label n°30 (A++ → E)

Tolomeo basculante wall

p. 462

HALO 1x46W (E27)
or LED 1x8W (E27)
Lamp not included

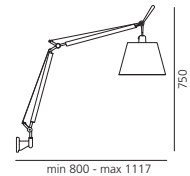

IP20 **ERC**

Energy Label n°30 (A++ → E)

Tolomeo mini wall

p. 456

Tolomeo mini LED wall

LED Total power 10W
Color temperature 3000K
Lighting output 480lm
CRI 80

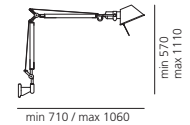

IP20 **ERC**

+ - Dimmer

Energy Label n°1 (A++ → A)

Tolomeo mini Halo wall

HALO 1x77W (E27)
or LED 1x8W (E27)
Lamp not included



IP20 **ERC**

Energy Label n°30 (A++ → E)

Tolomeo micro wall

p. 456

Tolomeo micro LED wall

LED Total power 8W
Color temperature 3000K
Lighting output 365lm
CRI 80

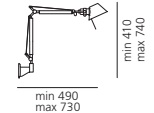

IP20 **ERC**

+ - Dimmer

Energy Label n°1 (A++ → A)

Tolomeo micro Halo wall

HALO 1x46W (E14)
or LED 1x4W (E14)
Lamp not included



IP20 **ERC**

Energy Label n°30 (A++ → E)

Tolomeo faretto

p. 458

Tolomeo faretto LED

LED Total power 10W
Color temperature 3000K
Lighting output 480lm
CRI 80



IP20

+ - Dimmer

Energy Label n°1 (A++ → A)

Tolomeo faretto Halo

HALO 1x77W (E27)
or LED 1x8W (E27)
Lamp not included

IP20

Energy Label n°30 (A++ → E)

Tolomeo micro faretto

p. 458

Tolomeo micro faretto LED

LED Total power 8W
Color temperature 3000K
Lighting output 365lm
CRI 80



IP20

+ - Dimmable

Energy Label n°1 (A++ → A)

Tolomeo micro faretto Halo

HALO 1x46W (E14)
or LED 1x6W (E14)
Lamp not included

IP20

Energy Label n°30 (A++ → E)

Tolomeo diffusore 18 wall

p. 466

HALO 1x46W (E27)
or LED DIM 1x9W (E27)
Lamp not included

IP20

+ - Dimmable

Energy Label n°30 (A++ → E)

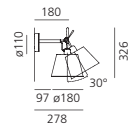

Tolomeo diffusore 24 wall

p. 466

HALO 1x77W (E27)
or LED DIM 1x10W (E27)
Lamp not included

IP20

+ - Dimmable

Energy Label n°30 (A++ → E)

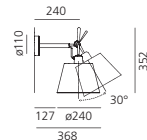

Tolomeo diffusore 32 wall

p. 466

HALO 1x150W (E27)
or LED DIM 1x21W (E27)
Lamp not included

IP20

+ - Dimmable

Energy Label n°30 (A++ → E)

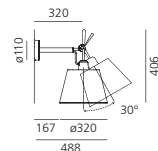

Tolomeo pinza

p. 460

Tolomeo pinza LED

LED Total power 10W
Color temperature 3000K
Lighting output 480lm
CRI 80



IP20

Energy Label n°1 (A++ → A)

Tolomeo pinza Halo

HALO 1x77W (E27)
or LED 1x8W (E27)
Lamp not included

IP20

Energy Label n°30 (A++ → E)

Tolomeo micro pinza LED

p. 460

Tolomeo micro pinza

LED Total power 8W
Color temperature 3000K
Lighting output 365lm
CRI 80



IP20

Energy Label n°1 (A++ → A)

Tolomeo micro pinza Halo

HALO 1x46W (E14)
or LED 1x6W (E14)
Lamp not included

IP20

Energy Label n°30 (A++ → E)

Tolomeo Mega wall

p. 464

Tolomeo Mega LED wall

LED Total power 31W
Color temperature 3000K
CRI 92

Lighting output
natural diffuser 1999lm-2016lm
grey diffuser 1894lm-1914lm
black diffuser 1681m-1693lm

IP20

+ - Dimmer

Energy Label n°1 (A++ → A)

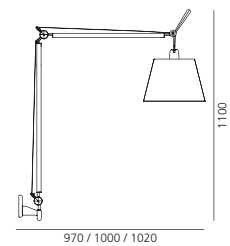

Tolomeo Mega Halo wall

HALO 1x150W (E27)
or LED 1x8W (E27)
Lamp not included

IP20

+ - Dimmer / On-Off Switch

Energy Label n°30 (A++ → E)



Trix

p. 510

LED Total power 23W
Color temperature 3000K
Lighting output 1965lm
CRI 90

IP20

+ - Dimmable (Push)

Energy Label n°1 (A++ → A)

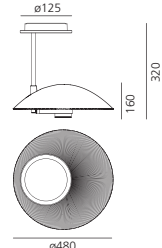

Vigo wall

p. 404

LED 1x6,8W LED DIM (GU10)
Lamp not included

IP20

+ - Dimmable

Energy Label n°9 (A+ → A)

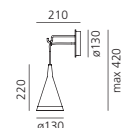

Aggregato

p. 574

HALO 1x77W (E27)
or LED DIM 1x10W (E27)
Lamp not included

IP20   **EAC**

+  Dimmable

Energy Label n°30 (A++ → E)

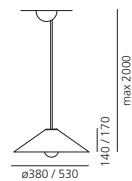

Aggregato saliscendi

p. 574

HALO 1x77W (E27)
or LED DIM 1x10W (E27)
Lamp not included

IP20  **EAC**

+  Dimmable

Energy Label n°30 (A++ → E)

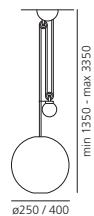

Alfa

p. 544

HALO 2x30W (E14)
or LED DIM 2x6W (E14)
Lamp not included

IP20  **EAC**

+  Dimmer

Energy Label n°30 (A++ → E)

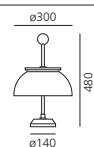

Boalum

p. 556

Data available on request

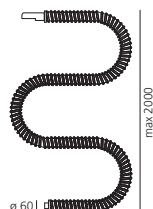

Callimaco LED

p. 558

LED Total power 45W
Color temperature 2700K / 3000K
Lighting output 3225lm / 3449lm
CRI 90 / 80

IP20  **EAC**

+  Dimmer

Energy Label n°1 (A++ → A)

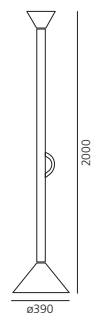

Chimera

p. 564

FLUO 3x28W (G5)
Lamp included

IP20   **EAC**

+  Dimmer

Energy Label n°23 (A++ → A)

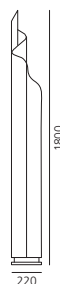

Dulcinea

p. 566

FLUO LINEAR 2x80 (G5)
+
FLUO 2x36W (2G10)
Lamps included

IP20 

Energy Label n°22 (A+ → A)

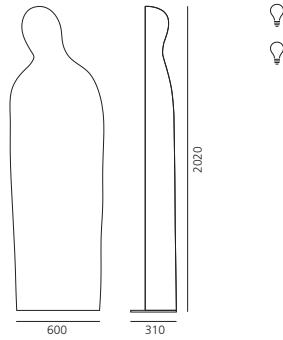

Metacolor LED

p. 588

Diffuse emission
LED Total power 150W
Color temperature RGB
Lighting output 3200lm

+  Dimmer

Presence light

LED Blue 4,5W
Not dimmable

IP20  

Energy Label n°1 (A++ → A)

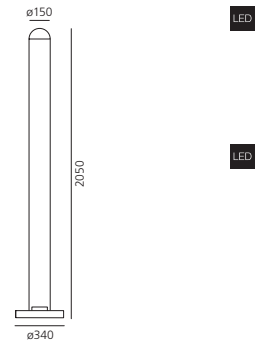

Eclisse

p. 546

HALO 1x25W (E14)
or LED 1x4W (E14)
Lamp not included

IP20  

Energy Label n°30 (A++ → E)



Mezzachimera

p. 564

HALO 3x46W (E27)
or LED 3x9W (E27)
Lamp not included

IP20  

Energy Label n°30 (A++ → E)



Fato

p. 552

HALO 2x30W (E14)
or LED 2x4W (E14)
Lamp not included

IP20 

Energy Label n°30 (A++ → E)



Montjuic

p. 568

HALO 1x400W (R7s)
or LED DIM 1x11W (R7s)
Lamp not included

IP20 

+  Dimmer

Energy Label n°30 (A++ → E)

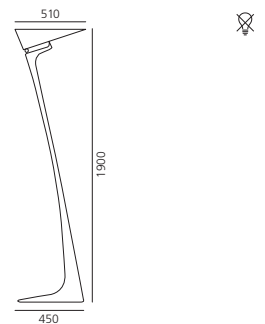

Hsiang

p. 580

LED Total power 41W
Color temperature Emotional light green,
red, yellow and blue

IP20 

Energy Label n°1 (A++ → A)

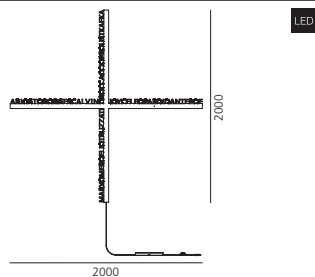

Nessino

p. 550

HALO 4x20W (E14)
or LED 4x2W (E14)
Lamp not included

IP20  

Energy Label n°30 (A++ → E)



Nesso

p. 550

HALO 4x20W (E14)
or LED 4x2W (E14)
Lamp not included

IP20  

Energy Label n°30 (A++ → E)

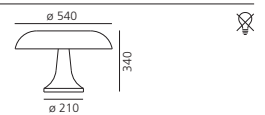

Lesbo

p. 548

HALO 1x77W (E27)
or LED DIM 1x10W (E27)
Lamp not included

IP20 

+  Dimmer

Energy Label n°30 (A++ → E)

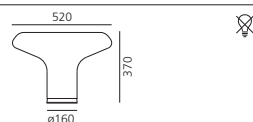

Noto

p. 576

FLUO 2x80W (G5)
Lamp included

IP20  

Energy Label n°33 (A+ → A)

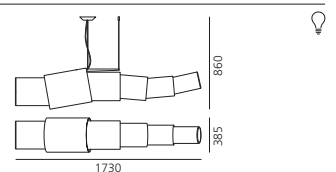

Pantalica suspension

p. 578

HALO 6x46W (E14)
or LED DIM 6x4W (E14)
Lamp not included

IP20 **EAC**

+ - Dimmable

Energy Label n°30 (A++ → E)

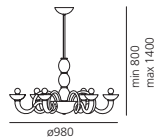

Pantalica 2 wall

p. 578

HALO 2x46W (E14)
or LED DIM 2x4W (E14)
Lamp not included

IP20 **EAC**

+ - Dimmable

Energy Label n°30 (A++ → E)

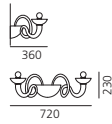

Pantalica 3 wall

p. 578

HALO 3x46W (E14)
or LED DIM 3x4W (E14)
Lamp not included

IP20 **EAC**

+ - Dimmable

Energy Label n°30 (A++ → E)

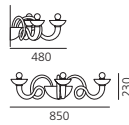

Patroclo

p. 554

HALO 1x77W (E27)
or LED DIM 1x10W (E27)
Lamp not included

IP20 **EAC**

+ - Dimmer

Energy Label n°30 (A++ → E)

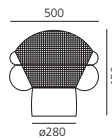

Pausania LED TW

p. 560

LED Total power 10W
Color temperature 2700-6500K
Lighting output 690lm
CRI 80

IP20 **EAC**

+ - Dimmer

Energy Label n°1 (A++ → A)

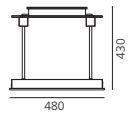

Pipe LED floor

p. 570

LED Total power 27W
Color temperature 2700K
Lighting output 1763lm
CRI 90

IP20 **EAC**

+ - Dimmer

Energy Label n°1 (A++ → A)

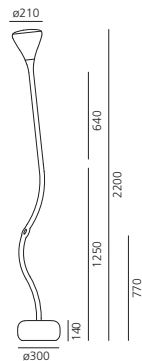

Pipe LED

p. 570

LED Total power 27W
Color temperature 2700K
Lighting output 1763lm
CRI 90

IP20 **EAC**

+ - Dimmable (Push)

Energy Label n°1 (A++ → A)



Pipe LED wall/ceiling

p. 570

LED Total power 27W
Color temperature 2700K
Lighting output 1763lm
CRI 90

IP20 **EAC**

+ - Dimmable (Push)

Energy Label n°1 (A++ → A)

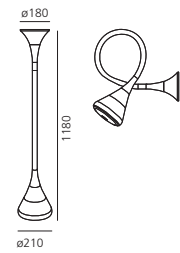

Prometeo LED

p. 582

Indirect emission
LED 4x15W (RGBW)

Diffused emission
LED Total power 25W
Color temperature 3000K
Lighting output 1600lm
CRI 90

IP20 **EAC**

+ - Dimmer

Energy Label n°1 (A++ → A)

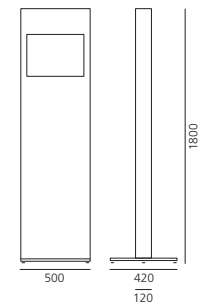

Shogun

p. 562

HALO 1x150W (E27)
or LED 1x8W (E27)
Lamp not included

IP20 **EAC**

Energy Label n°30 (A++ → E)

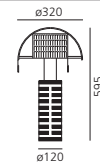

Yang

p. 584

Yang LED
LED Total power 3x15W
Color temperature RGB

IP20 **EAC**

+ - Dimmer

Energy Label n°1 (A++ → A)

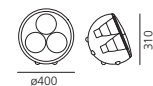

Yang

FLUO 3x42W (GX24q-4)
Lamp included

IP20 **EAC**

+ - Dimmer

Energy Label n°28 (A)



Fukurou p. 601

LED 1x20W (E27)
Lamp not included

IP20  
Energy Label n°2 (A++ → A)

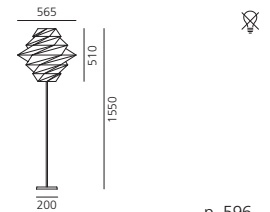

Mendori p. 596

LED Total power 8W
Color temperature 3000K
Lighting output 425lm
CRI 80

IP20  
+  Dimmer

Energy Label n°1 (A++ → A)

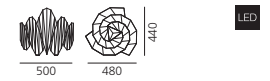

Mendori mini p. 596



LED 1x6W (E14)
Lamp included

IP20  
Energy Label n°36 (A++ → A)



Minomushi floor p. 602

LED Total power 28W
Color temperature 3000K
Lighting output 1745lm
CRI 80

IP20  
+  Dimmer

Energy Label n°1 (A++ → A)

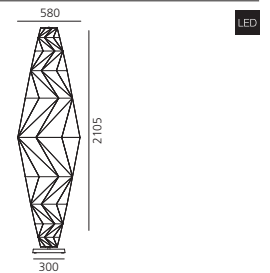

Minomushi suspension p. 603

LED Total power 28W
Color temperature 3000K
Lighting output 1745lm
CRI 80

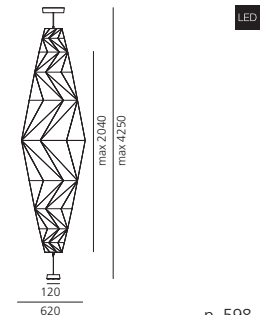

IP20  
+  Dimmable (push)

Energy Label n°1 (A++ → A)



Mogura mini p. 598

LED Total power 10W
Color temperature 3000K
Lighting output 371lm
CRI 80

IP20  
+  Dimmer

Energy Label n°1 (A++ → A)



Tatsuno-Otoshigo p. 604

LED Total power 28W
Color temperature 3000K
Lighting output 1500lm
CRI 80

IP20  
+  Dimmable (Push)

Energy Label n°1 (A++ → A)

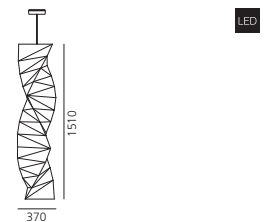

Wuni p. 605

LED DIM 1x20W (E27)
Lamp not included

IP20  
+  Dimmable
Energy Label n°2 (A++ → A)



Yadokari p. 600

LED 1x6W (E14)
Lamp not included

IP20  
Energy Label n°36 (A++ → A)



Download the Artemide app

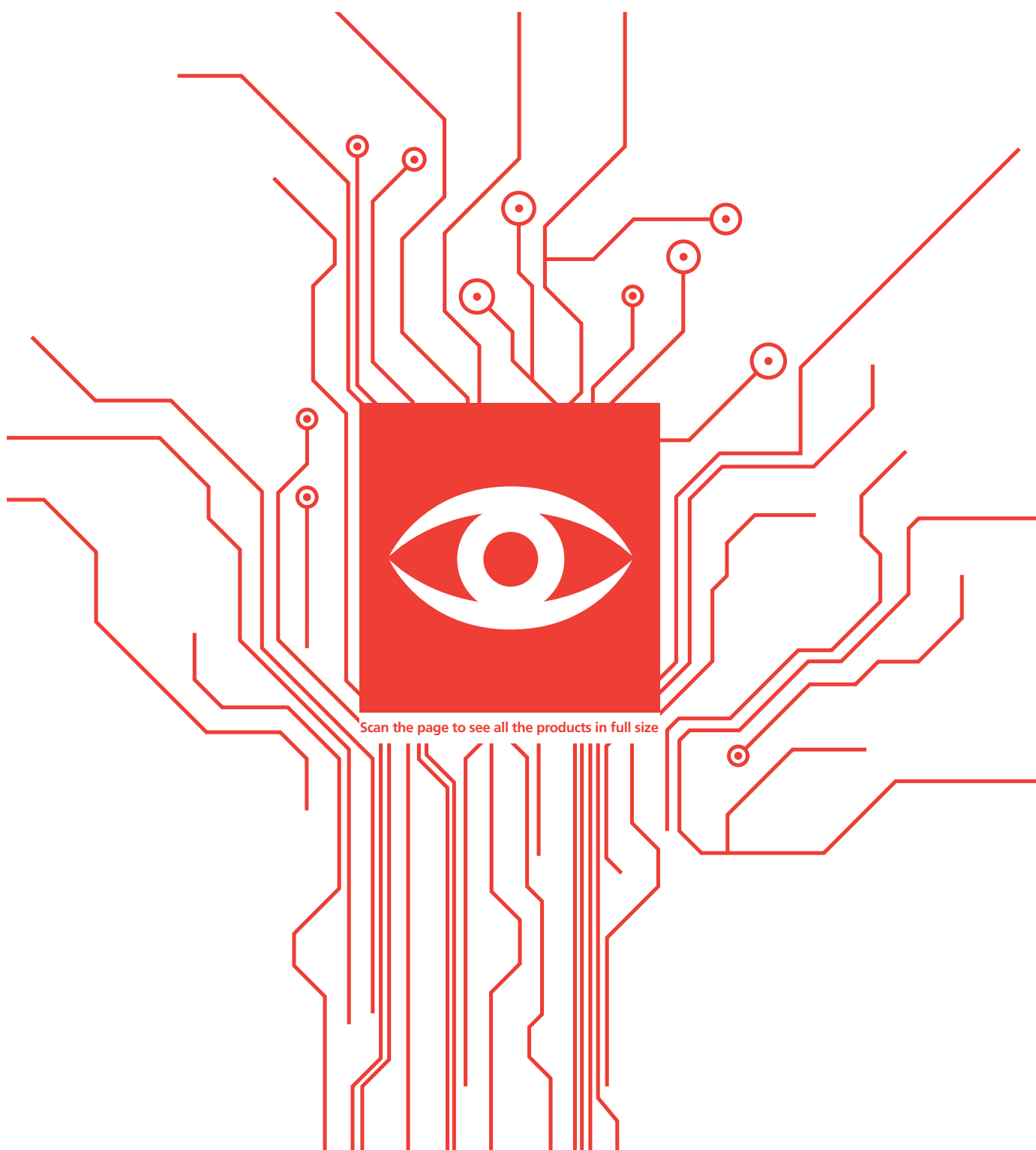

Scan the page to see all the products in full size

Artemide. Augmented reality

Launch Artemide app
and scan the page to see
the Augmented Reality
of all the products
in full size.

Questo è un catalogo interattivo. Utilizza un tablet
o uno smartphone per godere l'esperienza della Realtà
Aumentata e scoprire tutti i contenuti interattivi del catalogo.

This is an interactive catalogue. You can either use your tablet
or smartphone to enjoy the Augmented reality experience
and discover the interactive contents of the catalogue.

Ceci est un catalogue interactif. Vous pouvez utiliser votre
tablette ou votre smartphone pour profiter de l'expérience
de la Réalité Augmentée et ainsi découvrir tous les contenus
interactifs du catalogue.

Dies ist ein interaktiver Katalog. Sie können sowohl Ihr Tablet
als auch Ihr Smartphone nutzen, um den interaktiven Inhalt
dieses Kataloges zu entdecken und die Augmented Reality
zu erleben.

Este es un catálogo interactivo. Usted puede utilizar su tableta
o smartphone para disfrutar de la experiencia Augmented reality
y descubrir todos los contenidos interactivos del catálogo.

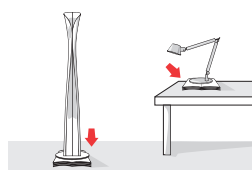

Posiziona il catalogo nella posizione in cui
desideri vedere la lampada all'interno della tua
casa o del tuo ufficio.

Place the catalogue in the required location
to see the 3D model of the product in your
house or office.

Placez le catalogue à l'endroit où vous souhaitez
voir le produit dans votre maison ou votre
bureau.

Platzieren Sie den Katalog an dem Ort,
an dem Sie das ausgewählte Produkt zu Hause
oder im Büro sehen möchten.

Coloque el catálogo en el lugar que se desea
ver el producto alrededor de su casa u oficina.

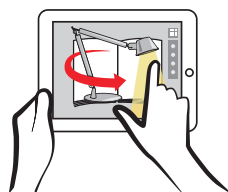

Sperimenta la 3D Augmented Reality.
Accendi e spegni la lampada toccando
il "logo lampadina".

Enjoy the 3D Augmented reality.
Touch the "bulb logo" to turn the light ON
and OFF.

Profitez de la réalité augmentée 3D et appuyez
sur le « logo ampoule » pour allumer
ou éteindre le luminaire.

Erleben Sie Augmented Reality.
Schalten Sie mit dem Lichtschalter das Licht
AN und AUS.

Disfrute de la Augmented reality en 3D.
Toque el "logo bombilla" para encender
o apagar la luz



Sfoglialo il menu per vedere tutti i colori,
le caratteristiche tecniche e connettiti
al sito web di Artemide per avere maggiori
informazioni.

Browse the menu to see all the finishes,
technical features and connect to Artemide
website for more information.

Parcourez le menu pour voir tous les coloris,
les caractéristiques techniques et également
se connecter au site Artemide pour plus
d'informations.

Im Menü finden Sie Farbvarianten, technische
Informationen und die direkte Verlinkung zur
Artemide Website für weitere Informationen.

Explorar el menú para ver todos los colores,
características técnicas y conectarse a la página
web Artemide para más información.

5 YEARS

WARRANTY

Artemide®

Artemide è da sempre sinonimo di prodotti di alta qualità. A conferma di ciò, siamo lieti di informare che a partire dal 1 aprile 2015, è offerta a tutti i suoi utilizzatori finali (solo utilizzatori privati), in tutto il mondo, una garanzia gratuita estesa a 5 anni, previa corretta registrazione online del prodotto entro i 2 mesi dalla data di acquisto.

Le condizioni principali della garanzia 5 anni, sono le seguenti:

- Essere un utilizzatore finale (acquirente privato);
- Aver acquistato il prodotto Artemide dopo il 1 aprile 2015;
- Aver registrato il prodotto on-line entro 2 mesi dalla data di acquisto;
- Il prodotto acquistato deve essere nuovo (non di seconda mano);
- Essere il primo acquirente del prodotto (la garanzia non è trasferibile).

La suddetta garanzia, correttamente attivata e azionata, conferirà al cliente privato il diritto di ottenere da Artemide la riparazione o la sostituzione gratuita del prodotto riconosciuto affetto da difettosità del materiale o vizio di produzione così come previsto dalle condizioni di validità della garanzia.

Ulteriori informazioni sono reperibili sul sito:
[cloud.artemide.com/
5-years-warranty](http://cloud.artemide.com/5-years-warranty)

Artemide has always provided high quality products. As a result, we are glad to inform you that from April 1st 2015 we offer to all our end users worldwide (private consumers only) a free 5-year extended warranty, valid only if the product is successfully registered online within two months from the date of purchase.

Artemide a toujours été synonyme de produits de grande qualité. Confirmant cet état de fait, nous sommes heureux de vous informer qu'à compter du 1er Avril 2015, Artemide offre à ses utilisateurs finaux (uniquement les particuliers) dans le monde entier une garantie étendue à 5 ans, si le produit est enregistré avec succès dans les deux mois suivants la date d'achat.

Artemide ist seit jeher Synonym für hochwertige Produkte. Als Zeugnis unserer Qualität freuen wir uns, ab dem 1. April 2015 allen Endverbrauchern (nur Konsumenten) weltweit eine kostenlose Garantie mit einer Laufzeit von 5 Jahren anbieten zu können. Voraussetzung hierfür ist eine erfolgreiche Online-Registrierung des Produkts innerhalb von 2 Monaten ab Kaufdatum.

Artemide es desde siempre sinónimo de productos de calidad. Como confirmación de esto, nos complace informarle que a partir del 1 de abril 2015, se ofrecerá a todos los usuarios finales (sólo consumidores privados) en todo el mundo una garantía extendida gratuita de 5 años, si el producto se ha registrado con éxito dentro de los dos meses posteriores a la fecha de compra.

Conditions for the 5-year extended warranty are as follows:

- Being an end user (private consumer);
- Purchasing the Artemide product after April 1st 2015;
- Registering the product online within 2 months from the date of purchase;
- The product must be new (not second-hand);
- Being the first owner of the product (the warranty is not transferable).

Les conditions de cette garantie de 5 ans sont principalement les suivantes:

- Être un particulier (consommation privée);
- Avoir acheté le produit Artemide après le 1er Avril 2015;
- Avoir enregistré le produit en ligne dans les deux mois suivants la date d'achat;
- Le produit doit être neuf (les produits d'occasion ne sont pas considérés);
- Être le premier propriétaire du produit (la garantie n'est pas cessible).

Die wichtigsten Bedingungen für die 5-Jahres-Garantie sind:

- Sie sind Endverbraucher (privater Konsument)
- Sie haben das Artemide-Produkt nach dem 1. April 2015 erworben
- Sie haben das Produkt innerhalb von 2 Monaten ab Kaufdatum online registriert
- Es handelt sich um ein neues Produkt (nicht aus zweiter Hand)
- Sie sind Erstkäufer des Produkts (die Garantie ist nicht übertragbar).

Las condiciones principales de la garantía de 5 años, son las siguientes:

- Ser consumidor final (consumo privado);
- Haber comprado el producto Artemide después del 1º abril 2015;
- Haber registrado el producto on-line en los 2 meses posteriores a la compra;
- El producto que ha comprado tiene que ser nuevo (no de segunda mano);
- Ser el primer propietario del producto (la garantía no es transferible).

Following successful online activation and claim, the extended warranty will entitle the private customer to a free repair or replacement when the product is determined to be faulty due to manufacturing defect, as stated on its terms and conditions.

For further information please go to:
cloud.artemide.com/5-years-warranty

La garantie mentionnée ci-dessus, si elle est réclamée et activée avec succès en ligne, permettra au client d'avoir la réparation ou le remplacement de son produit Artemide gratuitement par Artemide après constatation d'un défaut de fabrication ou de matériel comme prévu dans les termes de cette garantie.

Pour plus d'informations aller sur:
cloud.artemide.com/5-years-warranty

Nach erfolgreicher Registrierung und Reklamierung im Schadensfall hat der Verbraucher im Rahmen der Garantiebedingungen Anspruch auf kostenlose Reparatur oder Ersatz sofern es sich um Material- oder Herstellungsmängel handelt.

Weitere Informationen finden Sie unter:
cloud.artemide.com/5-years-warranty.

La garantía mencionada anteriormente, activada correctamente y accionada, dará derecho al cliente a obtener por parte de Artemide la reparación o la sustitución gratuita del producto del que se reconoce un defecto del material o de fabricación, conforme a lo dispuesto por los términos de la garantía.

Para más información por favor visite:
cloud.artemide.com/5-years-warranty

ArtemideTCO®

Artemide da sempre sviluppa soluzioni di luce che integrano le tematiche legate a spazi architettonici e spazi di vita nel segno della sostenibilità, condividendo competenza e know how con architetti e lighting planner.

Artemide è sensibile non solo alla progettazione a favore dell'uomo, ma anche al rispetto delle risorse del Pianeta, offrendo un nuovo servizio relativo al tema del risparmio energetico e dell'impatto economico del progetto.

Infatti attraverso **Artemide TCO - Total Cost Ownership** - uno strumento di calcolo di ultima generazione, è possibile proporre oggi soluzioni di controllo della luce e degli impianti che garantiscano un consumo mirato delle risorse energetiche, partendo da stime puntuali dei costi di installazione e di utilizzo degli apparecchi.

Con i suoi **Lighting Consultancy Center** worldwide Artemide offre un servizio completo sul territorio di supporto al Lighting Engineering Project, attivando un costante dialogo con i suoi Partner.

Inoltre è possibile accedere al servizio di consulenza online attraverso il sito web **artemide.com**, consultare i dati tecnici ed effettuare il download di tutti gli strumenti necessari per eseguire in autonomia il proprio progetto luce.

$$\text{TCO} = \text{€}_{\text{system}} + \text{€}_{\text{maintenance}} + (\text{W}_{l,t} + \text{W}_{p,t}) \cdot \text{€}_{\text{kWh}}$$

TCO: Total Cost Ownership

$\text{W}_{l,t}$: absorbed energy with lamps on $P_n \cdot t_d \cdot (F_d \cdot F_o \cdot F_c) + P_n \cdot t_n \cdot (F_o \cdot F_c)$ [kWh]

$\text{W}_{p,t}$: absorbed parasitic energy with lamps off $P_{pc} \cdot [t - (t_d + t_n)] + P_{em} \cdot t_e$ [kWh]

Artemide develops lighting solutions integrating architectural and living spaces, always with a keen eye on sustainability, sharing expertise and knowledge with architects and lighting planners.

Artemide is sensitive not only to the needs of individuals, but also to the environment, offering a new service aimed at energy saving and to help in reducing costs. This service is called Artemide TCO - Total Cost Ownership and it is one of the latest generation calculation tools. Starting from precise estimates of installation and usage costs, it offers solutions for controlling equipment and installations requiring a targeted consumption of energy.

With its Lighting Consultancy Centres worldwide, Artemide offers customers a complete service to support lighting engineering plans, beginning a constant dialogue with its partners.

Lighting professionals can download the Dialux and Luxart calculation programs, Eulumdat data, 2D and 3D images of products from the artemide.com website, together with all the technical information needed to implement your own lighting project.

Depuis toujours Artemide développe des solutions d'éclairage permettant d'intégrer les thématiques architecturales et propres aux espaces de vie à celles de l'éco-responsabilité et cela grâce à un partage continu de ses compétences et de son savoir faire avec les architectes et les lighting planners.

Artemide n'est pas uniquement sensible aux besoins de l'Homme mais elle est également attentive au respect des ressources de la Planète: cette sensibilité se traduit dans la mise à disposition d'un service relatif à l'épargne énergétique et à l'impact économique du projet. En effet par l'intermédiaire de **Artemide TCO - Total Cost Ownership** - un instrument de calcul de dernière génération, Artemide propose des solutions de gestion de l'éclairage et des implantations capables de garantir des consommations ciblées des ressources énergétiques grâce à des estimations ponctuelles des coûts d'installation et d'utilisation des appareils.

Par le biais de ses **Lighting Consultancy Center** dans le monde entier, Artemide propose un service complet de support sur le territoire au Lighting Engineering Project en garantissant ainsi un dialogue constant avec ses partenaires.

De plus un service de consultation est disponible en ligne sur le site **artemide.com**: il est ainsi possible de prendre connaissance des données techniques ainsi que les 2D et 3D et d'effectuer le téléchargement de l'ensemble des instruments nécessaires afin de réaliser son propre projet d'éclairage en toute autonomie.

In einem architektonischen Projekt spielt Licht eine wesentliche Rolle. Planer setzen sich mit spezifischen und realen Anforderungen an die Beleuchtung auseinander.

Artemide arbeitet seit Beginn mit Architekten und Lichtplaner zusammen und unterstützt sie hierbei mit langjähriger Expertise. Hierbei ist das Thema Energieeinsparung von besonderer Bedeutung. Die eigens von Artemide entwickelte Software **Artemide TCO - Total Cost Ownership** - bietet Steuerungslösungen, die einen gezielten Verbrauch der energetischen Ressourcen ermöglichen.

Mit seinen **Light-Consultancy-Centern** bietet Artemide seinen Kunden einen kompletten Service, der auch die Unterstützung im Bereich Lichtplanung umfasst. Dies repräsentiert die finale Phase eines komplexen Verfahrens, das sich durch den konstanten Dialog zwischen Artemide Beratern, dem für das Projekt verantwortlichen Architekten sowie dem Lichtplaner auszeichnet.

Auf unserer Internetseite **artemide.com** erhalten Sie per Download die Lichtrechnungsprogramme Dialux und Luxart, Eulumdat-Dateien, 2D- und 3D Abbildungen der Produkte sowie alle weiteren erforderlichen technischen Informationen, um Ihr Beleuchtungsprojekt selbstständig erstellen zu können.

Artemide desde siempre desarrolla soluciones de luz que integran temáticas legadas a espacios arquitectónicos y espacios de vida que tengan que ver con la sostenibilidad, compartiendo competencia y know how con los arquitectos y los lighting planner.

Artemide es sensible no sólo en el diseño a favor del hombre, sino también en el respeto de los recursos del Planeta, ofreciendo un nuevo servicio que se refiere al tema del ahorro energético y el impacto económico del proyecto. De hecho a través del **Artemide TCO - Total Cost Ownership** - un instrumento de cálculo de última generación, ahora es posible proponer soluciones de control de la luz y de sistemas que garanticen un consumo selectivo de los recursos energéticos, a partir de las estimaciones puntuales de los costos de instalación y operación de los equipos.

Con sus 55 **Lighting Consultancy Center** en el mundo, Artemide ofrece un servicio completo en el área de soporte al Proyecto de Ingeniería de iluminación, lo que permite un diálogo constante con sus Partners.

También se puede acceder al servicio de consulta en línea a través de la web **artemide.com**, consultar los datos técnicos y descargar todas las herramientas necesarias para poder trabajar de forma autónoma en el propio proyecto de iluminación.

Legenda generale

General legenda
Légende générale
Zeichenerklärung
Leyenda general

Lamps typology



Lampade da tavolo
Table lamps
Lampes de table
Tischleuchten
Lámparas de sobremesa



Lampade da terra
Floor lamps
Lampadaires
Stehleuchten
Lámparas de pie



Lampade a sospensione
Suspension lamps
Suspensions
Pendelleuchte
Lámparas de suspensión



Lampade da parete
Wall lamps
Appliques
Wandleuchten
Apliques



Lampade da soffitto
Ceiling lamps
Plafonniers
Deckenleuchten
Pláfonos



Diretta
Direct
Directe
Direkt
Directa



Indiretta
Indirect
Indirecte
Indirekt
Indirecta



Diretta e indiretta
Direct and indirect
Directe et indirecte
Direkt und indirekt
Directa e indirecta



My White Light



Diffondente
Diffused
Diffuse
Gestreut
Difusa



Orientabile
Adjustable
Orientable
Verstellbar
Orientable



Metamorfosi

My White Light

Metamorfosi

My White Light

Metamorfosi

Protection degree

IP20

Gli apparecchi elettrici sono predisposti per impedire l'intrusione e il contatto di corpi solidi e liquidi con le parti in tensione. La resistenza alla penetrazione di solidi o liquidi è espressa dalla sigla IP, seguita da due numeri che esprimono il grado di protezione: la prima cifra è riferita ai corpi solidi, la seconda ai liquidi.

Electric fittings are preset in order to prevent the intrusion and contact with solids and liquids with live parts. Resistance against the penetration of solids and liquids is expressed by the initials IP, followed by two digits that stand for the degree of protection: the first referring to solids, the second to liquids.

Les appareils électriques sont conçus afin d'éviter toute intrusion ou contact de corps solides et liquides avec les parties sous tension. La résistance à la pénétration de solides ou liquides est exprimée par le sigle IP, suivi de deux chiffres qui expriment le degré de protection: le premier chiffre concerne les corps solides, le second les liquides.

Die Leuchten sind ausgestattet, um das Eindringen und den Kontakt von Festkörpern und Flüssigkeiten zu verhindern. Hinter den Kennbuchstaben "IP" gibt die erste Kennziffer den Fremdkörperschutz an, die zweite Kennziffer den Schutz gegen Eindringen von Wasser.

Los aparatos eléctricos están preparados para impedir la entrada y el contacto de cuerpos sólidos y de líquidos con las partes eléctricas. La resistencia a la penetración de sólidos y líquidos se expresa mediante las siglas IP seguidas de un número de dos dígitos que expresa el grado de protección: el primer dígito se refiere a los objetos sólidos, y el segundo, a los líquidos.

Class



Classe I - Class I - Classe I - Klasse I - Clase I
Apparecchio nel quale la sicurezza elettrica è garantita da un conduttore supplementare di protezione (messa a terra) collegato alla struttura metallica della lampada.

A light fitting whose safety is guaranteed by an additional protective conductor (earth) connected with the metal frame of the lamp.

Appareil où la sécurité électrique est garantie par un conducteur supplémentaire de protection (mise à la terre) connecté à la structure métallique de la lampe.

Beim Betrieb und bei der Wartung müssen alle berührbaren Metallteile der Leuchte, die im Fehlerfall Spannung annehmen können, leitend mit dem Schutzleiteranschluß verbunden sein.

La seguridad eléctrica está garantizada por un cable protector adicional (toma de tierra) conectado a la estructura metálica del aparato.



Classe II - Class II - Classe II - Klasse II - Clase II

Apparecchio nel quale la protezione contro la scossa elettrica non si basa unicamente sull'isolamento fondamentale, ma anche sulle misure supplementari di sicurezza costituite dal doppio isolamento o dall'isolamento rinforzato.

Queste misure non comportano dispositivi per la messa a terra e non dipendono dalle condizioni di installazione.

Light fittings whose safety is guaranteed by the double reinforced insulation of conductive parts, with no earth.

Appareil où la sécurité électrique est garantie par un double niveau d'isolation sans dispositif de mise à la terre.

Bei Leuchten der Klasse II ist der Erhöhungsschutz durch eine Schutzisolation gegeben. Alle spannungsführenden Teile haben außer der Betriebsisolation noch eine zusätzliche Isolation.

Aparatos con protección contra descargas eléctricas basada no sólo en el aislamiento fundamental sino también en medidas adicionales de seguridad constituidas por un doble aislamiento o un aislamiento reforzado.

Estas medidas no incluyen dispositivo de toma de tierra y no dependen de las condiciones de la instalación.

Approvals



Certificazione di conformità europea
Certification of European conformity
Certificat de conformité à la norme Européenne
Zertifizierung nach der europäischen Norm
Certificado de conformidad europeo



Certificazione di conformità valida per l'unione doganale EurAsEC
Certification for Eurasian Customs Union
Certificat de conformité pour la Union douanière Eurasienne
Zertifizierung nach der europäischen Norm für die Eurasische Wirtschaftsgemeinschaft
Certificado de conformidad con validez para la Unión Euroasiática



China Compulsory Certification
China Compulsory Certification
Certificat de conformité pour la Chine
Zertifizierung nach der europäischen Norm für die China
Certificado de conformidad con validez para la China



Classe III - Class III - Classe III - Klasse III -
Clase III

Apparecchio in cui la protezione contro la scossa elettrica si basa sull'alimentazione a bassissima tensione di sicurezza (SELV) e in cui non si producono tensioni superiori alla stessa.

This light fixture is fitted with a protection device against electric shock that features a very low voltage power supply (SELV) and prevents it from generating higher voltages.

Appareil dans lequel la protection contre les chocs électriques se base sur l'alimentation à très basse tension de sécurité (SELV) et dans lequel ne se produisent pas de tensions supérieures à celle-même.

Diese Leuchte ist mit einer Schutzvorrichtung versehen, die einen Betrieb mit einer Schutzkleinspannung vorsieht (SELV) und keine höheren Spannungen zuläßt.

Aparatos en los que la protección contra descargas eléctricas se basa en un sistema de alimentación de bajo voltaje que impide que se generen voltajes superiores.

LED



Tutti gli apparecchi con sorgenti LED sono stati testati secondo la norma IEC 62471 o IEC/TR 62778 vigenti (sicurezza fotobiologica delle lampade).

All the appliances with LED sources have been tested according to the current IEC 62471 or IEC/TR 62778 standards (photobiological safety of lamps).

Tous les luminaires à sources LED ont été testés conformément aux normes actuelles CEI 62471 ou ECI/TR 62778 (sécurité photobiologique des lampes).

Alle Geräte mit LED-Lichtquellen sind nach der geltenden Norm IEC 62471 oder IEC/TR 62778 (photobiologische Sicherheit von Lampen und Lampensystemen).

Todos los aparatos con fuentes LED han sido probados de acuerdo con las normas IEC 62471 o IEC/TR 62778 vigentes (seguridad fotobiológica de las bombillas).



LED integrato non sostituibile
Not replaceable integrated LED source
LED intégrée non remplaçable
LED Leuchtmittel integriert
und nicht austauschbar
LED integrado no sustituible



LED retrofit

Con 2 linee di prodotti - Artemide Design e Artemide Architectural Indoor & Outdoor - Artemide offre una gamma completa di prodotti per l'illuminazione, in grado di risolvere le esigenze illuminotecniche legate a tutti i tipi di applicazione, indoor e outdoor.

With 2 product lines - Artemide Design and Artemide Architectural Indoor & Outdoor - Artemide offers a complete range of lighting equipment. These can be integrated to resolve the lighting engineering needs with all types of application, both indoor and outdoor.

Avec ses 2 lignes de produits - Artemide Design et Artemide Architectural Indoor & Outdoor - Artemide offre une gamme d'appareils d'éclairage complète. En les intégrant, nous sommes en mesure de répondre à toutes les exigences qui se posent à tous les types d'application de l'éclairage technique, tant en intérieur qu'en extérieur.

Mit seinen 2 Produktlinien - Artemide Design und Artemide Architectural Indoor & Outdoor - bietet Artemide eine komplette Palette an Beleuchtungsgeräten. Integriert man sie untereinander, sind sie in der Lage, allen Beleuchtungsanforderungen im Innen- und Außenbereich gerecht zu werden.

Con sus dos líneas de productos - Artemide Design y Artemide Architectural Indoor & Outdoor - Artemide ofrece una gama completa de aparatos de iluminación. Integrándolos es capaz de resolver la demanda luminotécnica relacionada con todos los tipos de aplicación, ya sea de interiores o de exteriores.

Attraverso il sito artemide.com e le linee telefoniche dedicate, Artemide garantisce un puntuale servizio customer care di assistenza pre e post vendita. Inoltre, iscrivendosi alla newsletter è possibile essere costantemente aggiornati sui nuovi prodotti, eventi e progetti.

Via the website artemide.com and the dedicated telephone lines, Artemide guarantees a prompt customer care service both pre- and post-sale. Furthermore, by signing up for the newsletter it is possible to be constantly updated on new products, events and projects.

Grâce au site artemide.com et aux lignes téléphoniques dédiées, Artemide garantit un service d'assistance à la clientèle, avant et après-vente. En outre, l'inscription à la newsletter permet d'être constamment informé sur les nouveaux produits, les événements et les projets.

Über die Site artemide.com und die dedizierten Telefonlinien gewährleistet Artemide einen pünktlichen Kundendienstservice vor und nach dem Verkauf. Durch Anmeldung ist es auch möglich, mit dem Newsletter konstant über neue Produkte, Events und Projekte auf dem Laufenden gehalten zu werden.

A través de su página Web artemide.com y de sus líneas telefónicas con dedicación exclusiva, Artemide garantiza un servicio de atención al cliente puntual, tanto de preventa como de posventa. Además, dándose de alta en nuestro boletín, es posible estar siempre al día sobre los nuevos productos, eventos y trabajos.

artemide.com
info@artemide.com

Sorgenti luminose

Light sources

Sources lumineuses



















Leuchtmittel





Lámparas

LED











See data in the product pages

LED











	6W	230V	E14	LED	warm white	2700K	470lm
	6W	230V	E27	LED	warm white	2700K	470lm
	9W	230V	E27	LED	warm white	2700K	806lm
	10W	230V	E27	LED	warm white	2700K	1055lm
	15W	230V	E27	LED	warm white	2700K	1522lm
	21W	230V	E27	LED	warm white	3000K	2452lm
	5,9W	230V	GU10	PAR16	warm white	3000K	350lm
	7,5W	230V	GU10	LED	warm white	3000K	560lm
	2W	230V	E14	LED	warm white	2700K	220lm
	4W	230V	E14	LED	warm white	2700K	270lm
	4W	230V	E14	LED	warm white	2700K	240lm
	6W	230V	E27	LED	warm white	2700K	470lm
	6W	230V	E27	PAR20	warm white	2700K	350lm
	6W	230V	E27	LED	warm white	2700K	650lm
	6W	230V	E27	LED	warm white	2700K	806lm
	8W	230V	E27	LED	warm white	2700K	900lm
	8W	230V	E27	LED	warm white	2700K	1000lm
	8W	230V	E27	LED	warm white	2700K	740lm
	8W	230V	E27	LED	warm white	2700K	900lm
	12W	230V	E27	LED	warm white	3000K	1000lm
	15W	230V	E27	LED	warm white	3000K	1150lm
	13W	230V	E27	LED	warm white	3000K	1400lm
	18W	230V	E27	LED	warm white	2700K	1521lm
	6,8W	230V	GU10	PAR16	warm white	3000K	350lm
	8W	230V	GU10	PAR16	warm white	3000K	470lm
	2,3W	230V	G9	LED	warm white	3000K	200lm
	11W	230V	R7s	LED	warm white	3500K	650lm
	11W	230V	R7s	LED	warm white	3000K	1100lm

	8,5W	12V	G53	AR111	warm white	2700K	450lm
	15,5W	12V	G53	AR111	warm white	3000K	800lm
	2,4W	12V	G4	LED	warm white	2700K	300lm
	2,5W	12V	GY6,35	LED	warm white	3000K	180lm

Halogen

	30W	230V	E27	HALO	warm white	2700K	405lm
	46W	230V	E27	HALO	warm white	2700K	700lm
	57W	230V	E27	HALO	warm white	2800K	915lm
	77W	230V	E27	HALO	warm white	2800K	1320lm
	116W	230V	E27	HALO	warm white	2800K	2135lm
	150W	230V	E27	HALO	warm white	2900K	2870lm
	205W	230V	E27	HALO	warm white	3000K	4200lm
	70W	230V	E27	R80	warm white	2800K	485lm
	20W	230V	E14	HALO	warm white	2700K	235lm
	30W	230V	E14	HALO	warm white	2700K	405lm
	46W	230V	E14	HALO	warm white	2700K	700lm
	120W	230V	R7s	HALO	warm white	2900K	2250lm
	160W	230V	R7s	HALO	warm white	2900K	3100lm
	230W	230V	R7s	HALO	warm white	2950K	5000lm
	330W	230V	R7s	HALO	warm white	2950K	5000lm
	400W	230V	R7s	HALO	warm white	3000K	9000lm
	20W	12V	G4	QT9	warm white	2800K	320lm
	33W	230V	G9	HALO	warm white	2700K	460lm
	48W	230V	G9	HALO	warm white	2800K	740lm
	60W	230V	G9	HALO	warm white	2800K	980lm
	100W	12V	G53	QR111	warm white	3000K	1013lm
	35W	12V	GY6,35	QT12	warm white	2900K	860lm
	50W	12V	GY6,35	QT12	warm white	3000K	1180lm
	20W	12V	G4	HALO	warm white	2800K	320lm

Fluorescent

	26W	230V	GX24q-3	TC-TEL	warm white	2700K	1800lm
	32W	230V	GX24q-3	TC-TEL	warm white	2700K	2400lm
	42W	230V	GX24q-4	TC-TEL	warm white	2700K	3200lm
	57W	230V	GX24q-5	TC-TEL	warm white	2700K	4300lm
	36W	230V	2G10	TC-F	warm white	3000K	2800lm
	55W	230V	2G11	TC-LEL	warm white	3000K	4800lm
	18W	230V	G24q-2	TC-DEL	warm white	3000K	1200lm
	20W	230V	E27	TC-TSE	warm white	2700K	1230lm
	23W	230V	E27	TC-TSE	warm white	2700K	1500lm
	20W	230V	E27	globe	warm white	2700K	1200lm
	23W	230V	E27	globe	cold white	6500K	1380lm
	8W	230V	E27	TC-HSE	warm white	2700K	500lm
	11W	230V	2G7	TC-SEL	warm white	3000K	900lm
	28W	230V	G5	T16	warm white	3000K	2600lm
	35W	230V	G5	T16	warm white	3000K	3300lm
	39W	230V	G5	T16	warm white	3000K	3500lm
	39W	230V	G5	T16	cold white	6500K	3325lm
	39W	230V	G5	T16	red	-	2450lm
	39W	230V	G5	T16	green	-	4100lm
	39W	230V	G5	T16	blue	-	850lm
	54W	230V	G5	T16	warm white	3000K	5000lm
	80W	230V	G5	T16	warm white	3000K	7000lm
	55W	230V	2GX13	T16-R	warm white	3000K	4200lm
	18W	230V	G13	T26	warm white	3000K	1350lm
	36W	230V	G13	T26	warm white	3000K	3300lm
	58W	230V	G13	T26	red	-	3800lm
	58W	230V	G13	T26	green	-	6700lm
	58W	230V	G13	T26	blue	-	1600lm

Etichetta energetica

Energy label
Etiquette énergétique
Energieeffizienzlabel
Etiqueta energética

In ottemperanza al Regolamento Delegato (UE) n. 874/2012 della Commissione del 12 luglio 2012, che integra la direttiva 2010/30/UE del Parlamento e del Consiglio europeo per quanto riguarda l'etichettatura indicante il consumo d'energia delle lampade elettriche e delle apparecchiature d'illuminazione, sul presente catalogo è riportato il numero di riferimento alla corrispondente Energy Label (EL). Il riferimento all'Energy Label è attribuito ad ogni singolo apparecchio per le configurazioni tecniche in essere alla data di edizione del presente catalogo. Artemide, alla luce delle variazioni nella disponibilità delle sorgenti e/o delle relative classificazioni energetiche monitora costantemente il parco sorgenti di proprio utilizzo e di riferimento e, ove necessario, si riserva di allineare la Classe Energetica dei propri prodotti a quella delle lampade alle quali fanno riferimento. Sul sito ufficiale di Artemide [artemide.com](http://www.artemide.com) – sezione "download area" – "etichetta energetica" - sono presenti e costantemente aggiornate le ENERGY LABEL – ETICHETTATURA ENERGETICA di ogni singolo codice prodotto Artemide.

In compliance with the Commission Delegated Regulation (EU) No 874/2012 of July 2012 supplementing supplementing Directive 2010/30/EU of the European Parliament and of the Council with regards to energy labeling of electrical lamps and luminaires, this catalog reports the reference number of the relevant Energy Label (EL). The reference to the Energy Label is assigned to each individual device based on its technical configuration at the date of edition of this catalogue. Taking in to consideration the development of the light bulb industry, Artemide always keeps its products updated based on the availability of light sources and/or their energy classification; all above said, Artemide reserves the right to align the Class Energy efficiency of its products to the one of the lamps to which they refer. On the official Artemide website www.artemide.com - "download area" - "energy label", updated ENERGY LABEL of each Artemide product code are present and constantly updated.

Suite à l'entrée en vigueur du Règlement délégué (UE) n. 874/2012 de la Commission du 12 juillet 2012 qui intègre la directive 2010/30 UE du Parlement et du Conseil Européen en ce qui concerne l'étiquetage indiquant la consommation énergétique des lampes électriques et des appareils d'éclairage - en vigueur - sur le tarif en question, est indiqué le numéro relatif de référence correspondant aux Energy Label (EL), présents dans ces pages. Une référence à l'Energy Label est attribuée à chaque appareil pour les configurations techniques en cours à la date d'édition du catalogue. A la lueur des variations en termes de disponibilités des sources et/ou des classifications énergétiques relatives, Artemide vérifie constamment l'ensemble des sources de référence et, là où il s'avère nécessaire, se réserve la faculté d'aligner la Classe Énergétique de ses propres produits à celle des lampes auxquelles ils font référence.

Sur le site officiel Artemide www.artemide.com - section «download area» - étiquette énergétique - sont indiqués pour chaque code produit Artemide. Ces Energy Label sont constamment mis à jour.

Entsprechend der Delegierten Verordnung (EU) Nr. 874/2012 der Kommission vom 12. Juli 2012 zur Ergänzung der Richtlinie 2010/30/EU des Europäischen Parlaments und des Rates im Hinblick auf die Energieverbrauchskennzeichnung von elektrischen Lampen und Leuchten wird in der vorliegenden Liste jeweils neben der Artikelnummer die entsprechende Energieverbrauchskennzeichnung angegeben.

Die Energieverbrauchskennzeichnung wird den Lampen und Leuchten jeweils für die zum Zeitpunkt der Veröffentlichung der vorliegenden Liste bestehenden technischen Konfigurationen zugeordnet.

Im Hinblick auf Änderungen bei der Lieferbarkeit von Leuchtmitteln und/oder bei den jeweiligen Energieverbrauchsklassen überwacht Artemide ständig die verwendeten und empfohlenen Leuchtmittel und behält sich Anpassungen bei der Energieverbrauchsklasse der eigenen Produkte entsprechend der Energieverbrauchsklasse der jeweils verwendeten Leuchtmittel vor.

Auf der offiziellen Artemide-Webseite www.artemide.com, Bereich „Download area“ - „Energie Label“, finden Sie die ständig auf aktuellem Stand gehaltenen ENERGIEEFFIZIENZLABEL (ENERGY LABELS) für die einzelnen Artemide-Artikel.

En cumplimiento del Reglamento oficial (UE) n. 874/2012 de la Comisión del 12 de julio 2012, que integra la 2010/30/UE del Parlamento y del Consejo europeo con respecto al etiquetado indicativo del consumo de energía de las lámparas eléctricas y de los aparatos de iluminación, en esta catálogo se muestra el número de referencia a la correspondiente Energy Label (EL). En referencia a la Energy Label se atribuye a cada aparato por sus configuraciones técnicas que tenían en la fecha de edición de la presente catalogo. Artemide, a la luz de los cambios en la disponibilidad de fuentes y / o relativas clasificaciones energéticas revisa constantemente la gama de bombillas de utilización propia o de referencia y, cuando sea necesario, se reserva alinear la Clase energética de sus propios productos a aquella de las lámparas a las cuales hace referencia.

En la web oficial de Artemide www.artemide.com - sección "download area" - "etiqueta energética" - se encuentran y constantemente actualizadas las ENERGY LABEL - ETIQUETA ENERGETICA de cada producto Artemide.

Energy label 1

This luminaire contains built-in LED lamps:

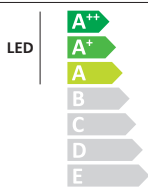

The lamps cannot be changed in the luminaire

Energy label 17

This luminaire contains built-in LED lamps:

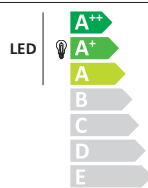

The luminaire is sold with a bulb of the energy class: A+

Energy label 23

This luminaire contains built-in LED lamps:

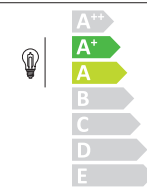

The luminaire is sold with a bulb of the energy class: A+

Energy label 34

This luminaire is compatible with bulbs of the energy classes:



Energy label 2

This luminaire is compatible with bulbs of the energy classes:

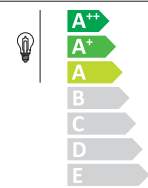

Energy label 18

This luminaire is compatible with bulbs of the energy classes:



The luminaire is sold with a bulb of the energy class: D

Energy label 26

This luminaire is compatible with bulbs of the energy classes:

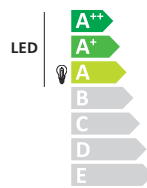

The luminaire is sold with a bulb of the energy class: A

Energy label 36

This luminaire contains built-in LED lamps:

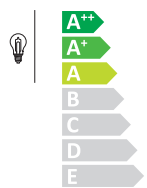

The luminaire is sold with a bulb of the energy class: A+

Energy label 7

This luminaire is compatible with bulbs of the energy classes:



Energy label 19

This luminaire is compatible with bulbs of the energy classes:



Energy label 28

This luminaire is compatible with bulbs of the energy classes:



The luminaire is sold with a bulb of the energy class: A

Energy label 54

This luminaire contains built-in LED lamps:

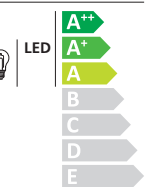

The luminaire is sold with a bulb of the energy class: A+

Energy label 8

This luminaire contains built-in LED lamps:

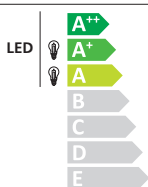

The luminaire is sold with a bulb of the energy class: A

Energy label 20

This luminaire is compatible with bulbs of the energy classes:

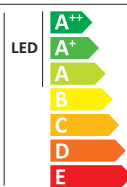

The lamps cannot be changed in the luminaire

Energy label 30

This luminaire contains built-in LED lamps:

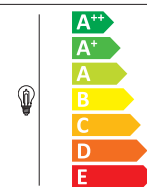

Energy label 62

This luminaire is compatible with bulbs of the energy classes:

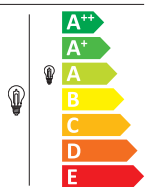

The luminaire is sold with a bulb of the energy class: A

Energy label 9

This luminaire is compatible with bulbs of the energy classes:

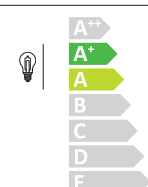

Energy label 22

This luminaire contains built-in LED lamps:



The luminaire is sold with a bulb of the energy class: A+ A

Energy label 33

This luminaire is compatible with bulbs of the energy classes:



The luminaire is sold with a bulb of the energy class: A

Headquarters

Artemide S.p.A.

Via Bergamo, 18
20010 Pregnana Milanese (MI), Italy
Tel. +39 02 93518.1
Tel. +39 02 93526.1
Numero verde 800 834 093
(from Italy only)
info@artemide.com
www.artemide.com

Communication and Marketing Department

Via Canova, 34
20145 Milan (MI), Italy
Tel. +39 02.349611
communication@artemide.com
www.artemide.com

Italy

Head office:

Artemide Italia s.r.l.

Via Bergamo 18
20010 Pregnana Milanese (MI)
Tel. +39 02 93518 1
Tel. +39 02 93526 1
Numero Verde 800 834 093
artemideitalia@artemide.com

Milano Monforte Showroom:

Corso Monforte 19
20122 Milano
Tel. +39 02 76006930
Tel. +39 02 794039
monforte@artemide.com

Milano Manzoni Showroom:

Via Manzoni 12
20121 Milano
Tel. +39 02 778712201
Tel. +39 02 778712202
manzoni@artemide.com

Milano Danese Showroom:

Piazza San Nazaro in Brolo 15
20122 Milano
Tel. +39 02 58304150
showroomdanese@artemide.com

Roma Margutta Showroom:

Via Margutta 107
00187 Roma
Tel. +39 06 36001802
Tel. +39 06 36001808
margutta@artemide.com

Treviso Showroom:

Via Campana 47
ang. Piazza San Francesco
31100 Treviso
Tel. +39 0422 410115
treviso@artemide.com

Milano Lighting Consultancy Center:

Via Manzoni 12
20121 Milano
Tel. +39 02 778712201
Tel. +39 02 778712202
manzonilighting@artemide.com

Roma Lighting Consultancy Center:

Via Pisanelli 1
00196 Roma
Tel. +39 06 94537550
pisanelli@artemide.com

Europe

Albania

Principal dealer:

A Bi Esse
Superstrada Tirane-Durres km 6
Yrshek, Tirane
Tel. +355 48 200416
info@abiess.eal

Austria

Head office and Showroom:

Artemide Handelsgesellschaft mbH
Gonzagagasse 1 / Morzinplatz
1010 Wien
Tel. +43 01 803 21 82
info@artemide.at

Azerbaijan

Principal dealer:

Studio 151
Port Baku Residence
Uzeyir Hacibeyov str. 151, 1001 Baku
Tel. +994 12 599 2040/41
studio151@office.az

Benelux (Belgium/Holland/Luxemburg)

Head office:

Horas S.A.
Beemdstraat 25
1601 Ruisbroek, Belgium
Tel. +32 02 334 84 50
artemide_benelux@artemide.com

Brussels showroom and Lighting Consultancy Center:

Chaussée de Waterloo 410
1050 Brussels - Belgium
Tel. +32 02 534 03 67
artemide.brussels@skynet.be

Amsterdam showroom and Lighting Consultancy Center:

Hobbemakade 89,
1071 XR Amsterdam Holland
Tel. +31 20 4702668
artemide.amsterdam@artemide.nl

Bosnia and Herzegovina

Sales Offices:

Artemide S.p.A.
Via Bergamo, 18
Tel. +39 02 93518 1
Tel. +39 02 93526 1
info@artemide.com

Bulgaria

Sales Offices:

Artemide S.p.A.
Via Bergamo, 18
Tel. +39 02 93518 1
Tel. +39 02 93526 1
info@artemide.com

Czech Republic

Principal dealer:

Selene spol. s.r.o.
Neumannova 161, 383 01 Prachatice
Tel. +420 388 310 326
selene@iol.cz

Showroom:

Myslikova 9
Praha 1 110 00

Showroom:

Sazavska 32
Vinhady 120 000 Praha 2

Cyprus

Sales Offices:

Artemide Hellas S.A.
34, Solonos St.
106 73 Athens
Tel. +30 210 3646770
info@artemide.gr

Croatia

Sales Offices:

Artemide S.p.A.
Via Bergamo, 18
Tel. +39 02 93518 1
Tel. +39 02 93526 1
info@artemide.com

Denmark

Head Office & Showroom:

Artemide Scandinavia A/S
Skudehavnsvej 5
DK-2150 Copenhagen
Tel. +45 7020 1700
info@artemide.dk

Estonia

Principal dealer:

Laterna Magica
Kreutzwaldi 8, 10124 Tallin
Tel. +372 6466 994
info@laterna.ee

France

Head Office and Showroom:

Artemide France S.A.S.
52, avenue Daumesnil, 75012 Paris
Tel. +33 01 43 44 44 44
artemide@artemide.fr

Finland

Head Office:

Artemide Scandinavia A/S
Skudehavnsvej 5
DK-2150 Copenhagen
Tel. +45 7020 1700
info@artemide.dk

Germany

Head office and Showroom:

Artemide GmbH
Hans-Böckler-Straße 2
58730 Fröndenberg
Tel. +49 02373 975 0
info@artemide.de

München Office:

Luise-Ullrich-Straße 20,
80636 München
Tel. +49 089 70065198
muenchen@artemide.de

Frankfurt Showroom:

Baseler Straße 10, 60329 Frankfurt
Tel. +49 069 3399 5690
frankfurt@artemide.de

Greece

Head office:

Artemide Hellas S.A.
34, Solonos St.
106 73 Athens
Tel. +30 210 3646770
info@artemide.gr

North Greece Branch Offices & Showroom

92, G. Papandreou St.
546 65 Thessaloniki
Tel. +30 2310 403934
thessaloniki@artemide.gr

Hungary

Principal dealer and Showroom:

Rio Lámpastúdió Kft.
Ráday u. 45.
H-1092 Budapest
Tel. +36 1 323 1637
rio@lampastudio.hu

Ireland

Sales Offices:

Artemide GB Ltd.
Tel. +44 20 7631 5200
info@artemide.co.uk

Kosovo

Principal dealer:

Light House Studio
Veternik nn, 1000 Prishtine
Tel. +386 43 733 333
info@lighthouse-kos.com

Latvia

Principal dealer:

Trentini Group
Lacplesa iela 101, 1011 Riga
Tel. +371 678 70890
info@artemide.lv

Lithuania

Principal dealer:

Delight LT UAB, Vytenyo 13
03112 Lithuania
Tel. +370 5 2104218
info@delight.lt

Malta

Sales Offices:

Artemide Italia s.r.l.
Tel. +39 02 93518 1
Tel. +39 02 93526 1
info@artemide.com

Montenegro

Principal dealer:

Artefacto + Design Center
Bulevar Svetog Petra Cetinjskog, Ulica 2
81000 Podgorica
Tel. +382 20 220-597
info@artefactoplus.me

Norway

Distributor:

Limelight AS
Sandakerveien 24C, inng. D9
No-0473 Oslo
Tel. +47 4000 1589
info@limelight.no

Poland

Head Office:

Artemide Dystrybucja Polska sp. z o.o.
Ul. Saperow 4, 82-300 Elblag
Tel. +48 55 236 11 85
info@liralighting.pl

Showroom:

Ul. Rydygiera 8, Warsaw

Portugal

Distributor:

Fluxograma S.A.
Rua da Garagem nº3
2794-021 Carnaxide
Tel. +351 214 257 500
fluxograma@fluxograma.com

Romania

Principal dealer:

Helios pls
Heliade intre Vii, nr 8, Etaj 2
023383 Bucarest

Russia

Head office:

Artemide Agency OOO
Bolshoj Zlatoustinskij Pereulok, Bldg 1, office
100, 101000 Moscow
Tel. +7 495 984 2238
info@artemide-agency.ru

Serbia

Sales Offices:

Artemide S.p.A.
Via Bergamo, 18
Tel. +39 02 93518 1
Tel. +39 02 93526 1
info@artemide.com

Slovakia

Principal dealer:

Akl s.r.o.
Vietnamská 45
82104 Bratislava
Tel. +421 907 767 008
info@aklsro.sk

Slovenia

Principal dealer:

Arcadia
Šmartinska 152 / hala E
1000 Ljubljana
Tel. +386 1 423 30 25
Tel. +386 1 423 40 25
info@arcadia-svetila.si

Spain

Head office:

Artemide S.A.
C/Vico, 12-18 bajos
08021 Barcelona
Tel. +34 093 478 391 1
artemide@artemide.es

Sweden

Head office:

Artemide Scandinavia A/S
Skudehavnsvej 5
DK-2150 Copenhagen
Tel. +45 7020 1700
info@artemide.dk

Switzerland

Head office and Showroom:

Artemide Illuminazione S.A.
Bärenegasse 16
8001 Zürich
Tel. +41 043 268 2727
info@artemide.ch

Turkey

Principal dealer:

Oztas Aydinlatma
Yskender Cad., 24
34420 Istanbul - Sishane
Tel. +90 212 237 52 36
info@oztasaydinlatma.com

United Kingdom

Head office, Showroom and Lighting Consultancy Center:

Artemide GB Ltd.
106 Great Russell Street
London WC1B 3NB
Tel. +44 20 7631 5200
info@artemide.co.uk

America

Canada

Head office:

Artemide Ltée/Ltd.
11105, rue Renaude Lapointe
Montréal, Québec H1J 2T4
Tel. +1 514 323 6537
Toll free +1 888 777 2783
infocanada@artemide.net
www.artemide.net

Flagship Store:

Toronto, ON
5 Mill Street
Toronto, Ontario M5A 3R6
Tel. +1 416 628 6718
toronto@artemide.net

Sales offices:

Montréal, QC
Tel. +1 514 323 6537
montreal@artemide.net

Toronto, ON

Tel. +1 416 628 6718
toronto@artemide.net

U.S.A.

Headquarters:

Artemide, Inc.
250 Karin Lane
Hicksville, NY 11801
Tel. +1 631 694 9292
Toll free +1 877 Art 9111
infousa@artemide.net
www.artemide.net

Flagship stores:

Chicago, IL
351 W Hubbard street
Chicago, IL 60654
Tel. +1 312 475 0100
chicago@artemide.net

Los Angeles, CA

9006 Beverly Boulevard
West Hollywood, CA 90048
Tel. +1 310 888 4099
losangeles@artemide.net

New York, NY

46 Greene Street
New York, NY 10013
Tel. +1 212 925 1588
newyork@artemide.net

Sales offices:

Denver, CO
351 W Hubbard street
Chicago, IL 60654
Tel. +1 877 278 9111
denver@artemide.net

Chicago, IL

Tel. +1 312 475 0100
chicago@artemide.net

Los Angeles, CA

Tel. +1 310 888 4099
losangeles@artemide.net

Miami, FL

Tel. +1 305 444 5800
miami@artemide.net

New York, NY

Tel. +1 212 925 1588
newyork@artemide.net

Central & South America Argentina

Distributor:

Head Office & Showroom:

Edimetra S.A.
Paraguay 792 3° Piso
1057 Buenos Aires
Tel. +54 11 4312-2590
info@artemide.com.ar

Bolivia

Showroom:

Studio Tessuto
Local 103, Urubó Business Center
Santa Cruz, Bolivia
Tel: +591 3 321 6313
info@studiotessuto.com

Brasil

Distributor:

Head Office & Showroom:

Cynthron
Rua do Rócio, 423, 18º andar,
Vila Olímpia
04552 000, São Paulo
Tel. +55 11 3846 8100
cynthron@cynthron.com.br

Chile

Showroom:

Interdesign
Isidora Goyenechea 3200
Las Condes, Santiago
Tel. +56 2 22314114
info@interdesign.cl

Colombia

Showroom:

Q Design Home
Cra. 11 No, 93-A-08 Local 2
Bogota, Colombia
Tel +05 1 8052666
www.qdesignhome.com

Dominican Republic

Distributor:

Spazio di Casa
Ave. Max Henriquez Ureña No.17
Ensanche Naco, Santo Domingo
Tel. +1 809 368 2001
info@spaziodicasa.com

Ecuador

Showroom:

Integral Iluminacion
Km. 2.5 Via Samborondon Tornero 3 Mz.
Solar 5, Guayaquil-Ecuador
Tel. +593 4 6000 622
info@integral.com.ec
www.integral.com.ec

Nicaragua

Showroom:

Michel Pierson
Edificio CAR 3, 2da planta
Planes de Altamira
Managua, Nicaragua
Tel. +505 2299 3936
Tel. +505 2299 3937
www.michelpierson.com.ni

Mexico

Distributor: Head Office, Showroom & Customer Service:

Scultura Luminosa
Suderman #246, Col. Chapultepec Morales
Mexico D.F. 11570
Tel. +52 55 5250 2661
info@artemide.mx

Panama

Showrooms:

Idea Design Center
Av. Samuel Lewis con Calle 59
Kenex plaza, Obarrio, Panama City
Rep. de Panama
Tel. +507 216 90 67
info@ideapanama.com

Lumicentro

Ave. Justo Arosemena, Esquina Calle 33
Ave. Ecuador. Edificio Lumicentro
Apartado 0816-01064
Panama City, Rep. de Panama
Tel. +507 300 2400
info@lumicentro.com

Peru

Showroom:

Hilite
Av. Los Conquistadores 575
San Isidro, Perú
Tel. +511 422 9123
ventas@hiliteperu.com

Uruguay

Showroom:

TRIOS Lighting
Luis de la Torre 593b
Montevideo, Uruguay
Tel. +598 2711 9260
info@trioslighting.com

Venezuela

Showroom:

Iluminación HELIOS
Av. San Felipe, Centro Coinasa, Mezzanina
La Castellana, Caracas 1060, Venezuela
Tel. +58 212 265 58 83
informacion@helios.com.ve

For information regarding distributors
and points of sale for Central & South
American countries not listed above,
please email:
infolatam@artemide.net

Asia / Oceania

Australia

Head office and Showroom:

Adelaide
Ornare Imports Pty. Ltd.
28 Fullarton Rd, Norwood SA 5067
Tel. +61 08 8362 3029
info@artemide.com.au
www.artemide.com

Office and Showrooms: Sydney

504-508 Cleveland St.
Surry Hills NSW 2010
Tel. +61 02 9699 8472
sydney@artemide.com.au

Melbourne

46-48 Rathdowne St.
Carlton VIC 3053
Tel. +61 03 9349 3310
melbourne@artemide.com.au

China

Head office:

Artemide Trading
(Shanghai) Co., Ltd.
Room 1907, 19/F, New Hualian
Mansion, East Wing, 755 Middle Huai
Hai Road, Huang Pu District, Shanghai
Tel. +86 21 6448 3650
info@artemide.cn

Affiliated Showrooms:

Beijing

Unit 1-B-20, International Furniture,
Hall 1, Easy Home, No. 65 North 4th
Ring Road, Chaoyang District, Beijing
Tel. +86 010 8463 6098
jinhongshijia@126.com

A81112, 1st Floor, Red Star Macalline
N°.193 East 4th Ring Road
Chaoyang District, Beijing
Tel. +86 010 8511 8718

Hong Kong and Macao

Head Office:

Artemide Ltd.
Unit 1303, 13/F, Ruttonjee House
Ruttonjee Centre, 11 Duddell Street
Central, Hong Kong
Tel. +852 2523 0050
info@artemide.com.hk

Showroom:

Shop 102-103, Ruttonjee Centre
11 Duddell Street, Central, Hong Kong
Tel. +852 2523 0333

India

Head office:

Artemide Lighting India Pvt. Ltd.
Unit N°. 5, 2nd floor, Raghuvanshi Mills
Compound, Senapati Bapat Marg, Lower
Parel, Mumbai - 400013, Maharashtra
Tel. +91 22 61774800
Tel. +91 9953554435
info@artemide.in
anindya@artemide.in

Region: West Showroom and Registered Office:

Unit N°. 5, 2nd floor, Raghuvanshi Mills
Compound, Senapati Bapat Marg, Lower
Parel, Mumbai - 400013, Maharashtra
Tel. +91 9920628841
Tel. +91 22 61774800
pramod.tambe@artemide.in
anindya@artemide.in
arun.khattri@artemide.in

Region: South

Tel. +91 9312829394
Tel. +91 9538998132
arun.khattri@artemide.in
ravi@artemide.in

Region: Delhi NCR

Showroom:

N°.5, Retreat Farms, Khullar Farms,
Ashok Lane, Mandi Road, Mehrauli
New Delhi - 110030
Tel. +91 9811163966
Tel. +91 9810945899
Tel. +91 8447147522
ashwani.gupta@artemide.in
dheeraj.kapoor@artemide.in
sumit@artemide.in

Region: North

Tel. +91 9811163966
Tel. +91 9810945899
ashwani.gupta@artemide.in
dheeraj.kapoor@artemide.in

Region: East

Tel. +91 9312829394
Tel. +91 9811163966
arun.khattri@artemide.in
ashwani.gupta@artemide.in

Indonesia

Sales Offices:

Artemide Ltd.
Tel. +852 2523 0050
info@artemide.com.hk

Japan

Head office:

Artemide Japan K.K.
#2013 1-41-7 Tomigaya Shibuya-ku
151-0063 Tokyo Japan
Tel. +81 3 5738 7410
info@artemide.co.jp

Malaysia

Distributor:

Lightcraft (KL) Sdn Bhd
145-5&6, Jalan Sungai Besi,
57100 Kuala Lumpur, Malaysia
Tel. +603 9222 4219
info@lightcraft.com.my

New Zealand

Distributor:

ECC Lighting
39 Nugent Street
Auckland
Tel. +64 9 379 9680
info@ecc.co.nz

61 Thorndon Quay
Tel. +64 4 473 3456
Wellington
info@ecc.co.nz

Philippines

Sales Offices:

Artemide Ltd.
Tel. +852 2523 0050
info@artemide.com.hk

Singapore

Distributor:

Million Lighting Co Pte Ltd
203 Kallang Bahru
Million Building, Singapore 339340
Tel. +65 6743 2033
enquiry@millionlighting.com
showrooms@millionlighting.com
www.millionlighting.com

South Korea

Distributor:

Duomo & Co.
735, Nonhyun-ro, Gangnam-gu
Seoul, Korea
Tel. +82 2 516 7083
info@duomokorea.com
www.duomokorea.com

Thailand

Sales Offices:

Artemide Ltd.
Tel. +852 2523 0050
info@artemide.com.hk

Taiwan

Distributor:

Mithus Co. Ltd.
4F, No. 236, Liancheng Rd.,
Zhonghe Dist.
New Taipei City
23553, Taiwan
Tel. +886 2 2221 1668
allen.chang@bravocasa.com.tw
www.mithus.tw

Vietnam

Distributor:

Cao Tran Co., Ltd
23 Tran Phu, P.4-Q.5
Ho Chi Minh City, Vietnam
Tel. +84 8 3833 3334
caotran@cara.com.vn
www.cara.com.vn

Middle East & Africa

Head office & Showroom:

Artemide Middle-East
Dubai Design District (D3)
Building 6 - 3rd Floor - Offices A307
Dubai, UAE
Tel. +971 4 425 0213
info@artemide.ae

For information regarding distributors
and points of sale for Middle East & Africa
countries, please email:
info@artemide.ae

© Artemide S.p.A.

Contents and editing
Carlotta de Bevilacqua
with
Cristina Costanzi
Diego Martinelli

Artemide Design Collection Department
Daniele Moioli

Artemide Research & Innovation
Fabio Zanola

Graphic design
Studio Cerri & Associati
Pierluigi Cerri
Alessandro Colombo
with
Roberto Libanori

Cover
Pierpaolo Ferrari

IN-El Issey Miyake photos
Hiroshi Iwasaki

Still lifes
Ballo & Ballo
Pierpaolo Ferrari
Jean Pierre Maurer
Manuel Maurer
Michele Nastasi
Gio Pini
Federico Villa
Miro Zagnoli

Image editing
and 3D visualization
Simone Fantoni

Prepress
Actualtype s.r.l.

Press
Faenza Group
March 2017



Compasso D'oro
1967-1989-1994-2004



Winner European
Design Prize '97



ISO 9001:2008



ISO 14001:2004



BILAN CARBONE®



CTF STAGE2
ISO 17025

We are a UL (Demko)
Customer Test Facility
Stage 2 participant

Artemide S.p.A.
si riserva la facoltà di modificare, in qualunque
momento e senza preavviso, le caratteristiche
tecniche degli elementi illustrati nel presente
catalogo.

Artemide S.p.A.
reserves the right to change, at any time and
without prior warning, the technical specifications
of any product illustrated in this catalogue.

Artemide S.p.A.
se réserve le droit de modifier, à n'importe
quel moment et sans préavis, les caractéristiques
techniques des éléments illustrés dans ce
catalogue.

Artemide S.p.A.
behält sich das Recht vor jederzeit und ohne
Ankündigung die technischen Daten der im
Katalog abgebildeten Produkte zu ändern.

Artemide S.p.A.
se reserva la facultad de modificar, en cualquier
y sin aviso previo, las características técnicas
de los elementos ilustrados en el presente
catálogo.

